

www.fishman.com

FISHMAN[®]

**USER GUIDE
LOUDBOX MINI**



Whenever this symbol appears, it alerts you to the presence of important operating and maintenance (servicing) instructions in the user's manual for this amplifier.



Wherever this symbol appears, it alerts you to the presence of uninsulated dangerous voltage inside the enclosure that may be sufficient to constitute a risk of shock.



Important Safety Instructions

To ensure your personal safety and the safety of others, operate this apparatus only after reading these instructions and heeding the warnings listed below.

1. Read these instructions.
 2. Keep these instructions.
 3. Heed all warnings.
 4. Follow all instructions.
 5. Do not use this apparatus near water.
 6. Clean only with a dry cloth.
 7. Do not block the ventilation openings. Install in accordance with the manufacturer's instructions.
 8. Do not install near any heat sources such as radiators, heat registers, stoves or other apparatus (including amplifiers) that produce heat.
 9. Do not defeat the safety purpose of the polarized or grounding-type plug. A polarized plug has two blades with one wider than the other. A grounding-type plug has two blades and a third grounding prong. The wide blade or the third prong are provided for your safety. If the provided plug does not fit into your outlet, consult an electrician for replacement of the obsolete outlet.
 10. Protect the power cord from being walked on or pinched, particularly at the plugs, convenience receptacles and the point where they exit from the apparatus.
 11. Use only attachments/accessories specified by the manufacturer.
 12. Use only with a cart, stand, tripod, bracket or table specified by the manufacturer, or sold with the apparatus. When a cart is used, use caution when moving the cart/apparatus combination to avoid injury from tip-over.
- 
13. Unplug this apparatus during lightning storms or when unused for long periods of time.
 14. Refer all servicing to qualified service personnel. Servicing is required when the apparatus has been damaged in any way, such as a power-supply cord or plug is damaged, liquid has been spilled or objects have fallen into the apparatus, the apparatus has been exposed to rain or moisture, does not operate normally, or has been dropped.
 15. Do not expose the apparatus to dripping or splashing liquids and do not place objects filled with liquids (such as a beverage container or a vase) on the apparatus.
 16. Warning" To reduce the risk of fire or electric shock, do not expose this apparatus to moisture.
 17. The apparatus should be connected to mains outlet with a protective earthing connection.



Disconnect device is Mains Plug, which should remain readily operable.

Copyright © 2010 FISHMAN TRANSDUCERS, INC.

All rights reserved. No part of this document may be reproduced in any form without the written permission of FISHMAN TRANSDUCERS, INC.

Before using Loudbox Mini, carefully read the following sections:
Important Safety Instructions (Page 2)
Getting Started (Page 5)

Save Your Packing Materials

The box and packing materials were specially designed to protect the amplifier during shipping. Save all this stuff in case you need to re-ship the Loudbox Mini.

Hear This!

The Loudbox Mini amplifier is capable of cleanly reproducing the sound of your instrument at very high volume levels. Prolonged repeated exposure to high sound pressure levels (SPLs) without protection can cause permanent hearing loss. OSHA has set guidelines and specified permissible sound-exposure limits for those who work in high SPL environments.

Permissible Noise Exposures

Duration per day, hours Sound level dBA slow response

8	90
6	92
4	95
3	97
2	100
1 1/2	102
1	105
1/2	110
1/4 or less	115

To ensure against permanent hearing loss, wear hearing protection when you perform with amplification.



NOTE: Operate the amplifier only at the voltage as indicated on the rear panel. Do not defeat the ground prong on the AC cable; the safe operation of this amplifier depends on a proper ground connection.

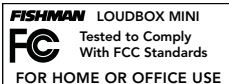

Welcome

Thank you for making Fishman a part of your acoustic experience. We are proud to offer the finest acoustic amplification products available; high-quality professional-grade tools which empower you to sound your very best.



Getting Started

Here are some basic setup tips to help get you going. To operate your Loudbox Mini safely, please read the entire manual, especially the Important Safety Instructions on page 2.

If your amplifier has an operating voltage of 120V, plug the provided AC line cord into the back of the amplifier.

If your amplifier operates at 230V, you must supply your own detachable power cord. The cord you supply must have an IEC-style 320 connector at one end and a male AC plug appropriate for your area at the other.

1. Locate the Power switch (next to the rear panel power cord terminal) and switch it off, then connect the power cord.
2. Plug the Loudbox Mini into an electrical outlet with the appropriate AC voltage.
3. Turn down the **Master Volume** control and turn on the **Power** switch.
4. Connect your instrument to the **Instrument** input with a shielded ¼" cable.
5. Raise the **Instrument** channel **Gain**:
 - For instruments featuring active (battery-powered) onboard preamps, start with the control around 10 o'clock.
 - For passive pickups, you may start with the control set much higher. It is normal to run this control near its maximum with many passive soundhole pickups.
6. Slowly raise the **Master Volume** to the desired level.

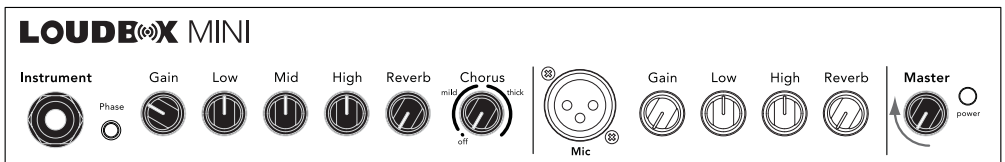

Front Panel

1. Instrument Input

This 1/4" input accepts all types of passive or active acoustic pickups.

2. Phase

Use the Phase switch to improve bass at low volume and suppress feedback at high volumes.

3. Gain

Use the Gain knob to set the signal level for the instrument input.

4. Low

Boost here to add weight to the sound. In general, boost bass at low volumes and flatten it out (or cut) at higher levels. With the dial set at 12 o'clock, the control is effectively out of the circuit.

5. Mid

This control affects how well the instrument blends in or stands out in the mix. At loud volumes a midrange cut will achieve a more natural sound. With the dial set at 12 o'clock, the control is effectively out of the circuit.

6. High

Boost highs to add "air" to the sound of the instrument. With the knob set at 12 o'clock, the control is effectively out of the circuit.

7. Reverb

Controls the amount of digital reverb in the Instrument channel.

8. Chorus

Controls the depth of two separate chorus presets.

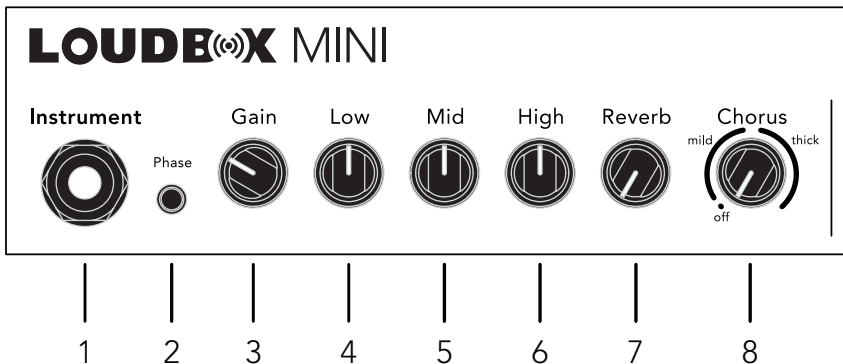

Front Panel (cont.)

9. Mic Input

Plug in a balanced mic into this XLR input for vocal or for your instrument. The Loudbox Mini makes an excellent mini-PA or vocal monitor. You may also connect an outboard preamp with balanced XLR out to this input.

10. Gain

Use the Gain knob to set the signal level for the Microphone input.

11. Low

Boost here to add weight to the microphone's sound. In general, boost bass at low volumes and flatten it out (or cut) at higher levels. With the dial set at 12 o'clock, the control is effectively out of the circuit.

12. High

Boost highs to add "air" to the sound of the microphone. With the knob set at 12 o'clock, the control is effectively out of the circuit.

13. Reverb

Controls the amount of digital reverb in the Microphone channel.

14. Master Volume

Set the overall level of the Loudbox Mini with the Master Volume. In general put the Master Volume as high as possible (2 o'clock to 5 o'clock) to achieve the cleanest sound.

15. Power

Lights up when the amplifier power is on. The Power switch is located behind the amp above the AC power cord terminal.

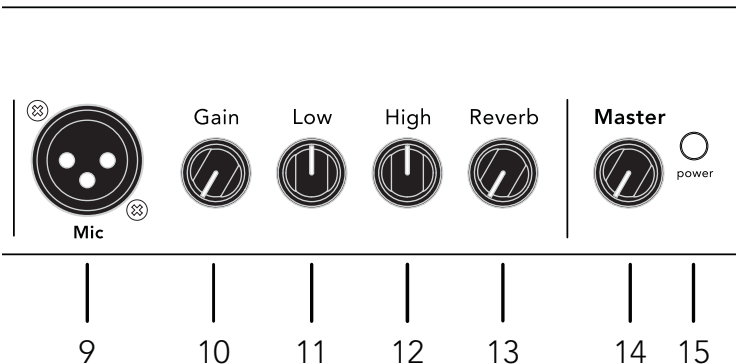

Rear Panel

1. AC power

Operate the amplifier only at the voltage indicated on the rear panel.

For 120V amplifiers purchased in the USA, Canada and Mexico, plug in the supplied detachable AC power cable.

For 100V and 230V amplifiers purchased outside the USA and Canada, you will need to supply your own detachable AC cable. This cable must have an IEC-style 320 connector at one end, and a male AC plug appropriate for your region at the other.



Disconnect device is AC inlet or power switch.

2. Power switch

Lower the Master Volume before you turn on the amp. Flip the power switch to the up position.

3 & 4. Aux Input - 1/4" & 1/8"

Plug in a line level stereo audio source such as a CD or MP3 player in this input. Both inputs may be used at the same time. They are stereo (TRS) inputs, however the left and right signals are mixed to mono.

5. Mix D.I. (Post)

Plug in here when you wish to send signals from both Channel 1 and 2 to a mixing console or a slave amplifier. This post-EQ output is always ground isolated to prevent ground loop hum.



Tone Tips

Set up

For reference, start with the tone controls flat (straight-up, twelve o'clock). In this position, there is no equalization applied to your sound. Begin at a very low volume and work your way up. As you turn up, try adjusting the Loudbox Mini's tone controls as recommended below.

1. Low volume

At a low volume (just above conversation level) our ears are not very sensitive to bass and treble, so give the Low and High controls a good boost. Try three o'clock on the dial.

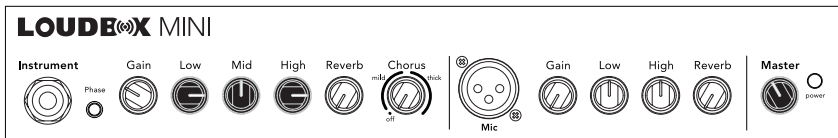

2. Medium volume

At medium levels, when you need to raise your voice to be heard over the music, the human ear is quite sensitive to midrange. Cut the Mid control to about ten o'clock or to your taste. At this level our perception of bass and treble starts to catch up to the rest of the tonal spectrum, so you can back off the Low and High knobs slightly for good tonal balance.

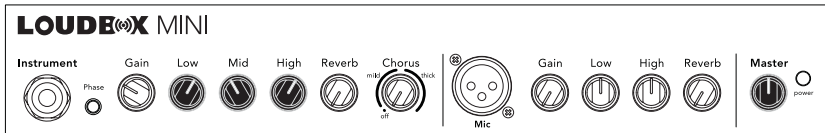

3. High volume

At loud levels, when you must shout to be heard over the music, your ears (and your audience) will benefit from a deep midrange cut. Set the Mid dial between nine and seven o'clock. Our perception of bass and treble "flattens out" at high volumes, so you won't need much, if any, Low or High boost. Set the Low and High knobs to between twelve and one o'clock. In many cases you can also improve the tone at very high volume if you cut bass. Try setting the Low knob between ten and eleven o'clock.

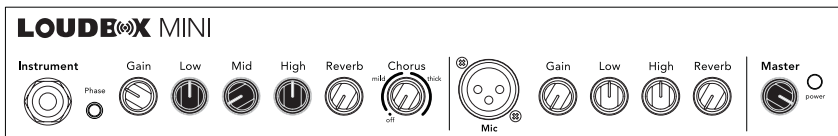

Block Diagram

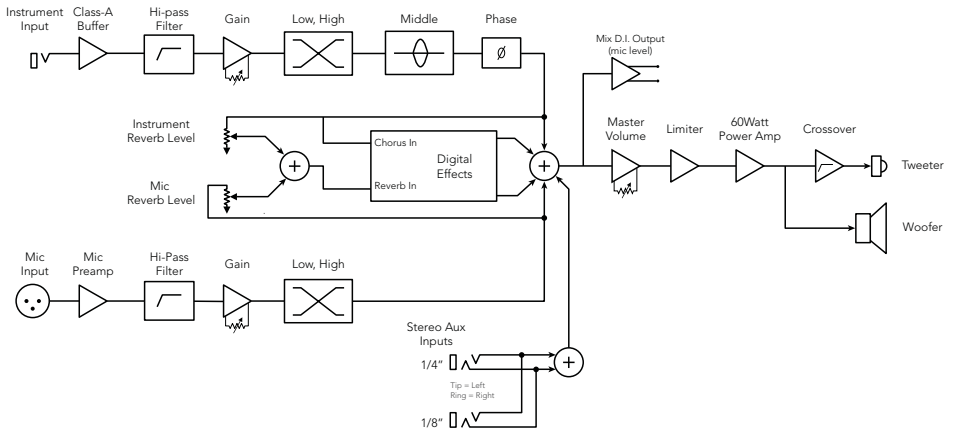

Technical Specifications

Rated power:

Output power	60Wrms
SPL @ 1 Meter	108dB SPL
Frequency Response	80Hz – 20kHz (-4dB)

Power consumption: 145W max

Input impedance:

Ch. 1	10M Ω
Ch. 2	2k Ω
Aux Input (stereo)	10k Ω

Tone controls:

Low	± 12 dB @ 80Hz (resonant)
Mid	± 10.5 dB @ 750Hz (resonant)
High	± 12.5 dB @ 15kHz (shelving)

Mix D.I. out:

Output Impedance	600 Ω balanced, mic level Phantom power tolerant, ground isolated
------------------	---

Speaker system:

Woofer	6.5" paper cone
Tweeter	1" soft dome,
Baffle Angle	10 Degrees

Physical:

Dimensions	9.7"D x 13.7"W x 12"H (24.7cm x 34.9cm x 30.5cm)
Weight	19.7 lbs (8.9 kg)

We reserve the right to change any of the specifications and information in this manual without notice.

FISHMAN

www.fishman.com