



AMPERO III STOMP

CDCM HD Gen 2 Amp Modeler / Effects Processor

USER'S MANUAL

For Firmware V1.0.2-V1.1.0

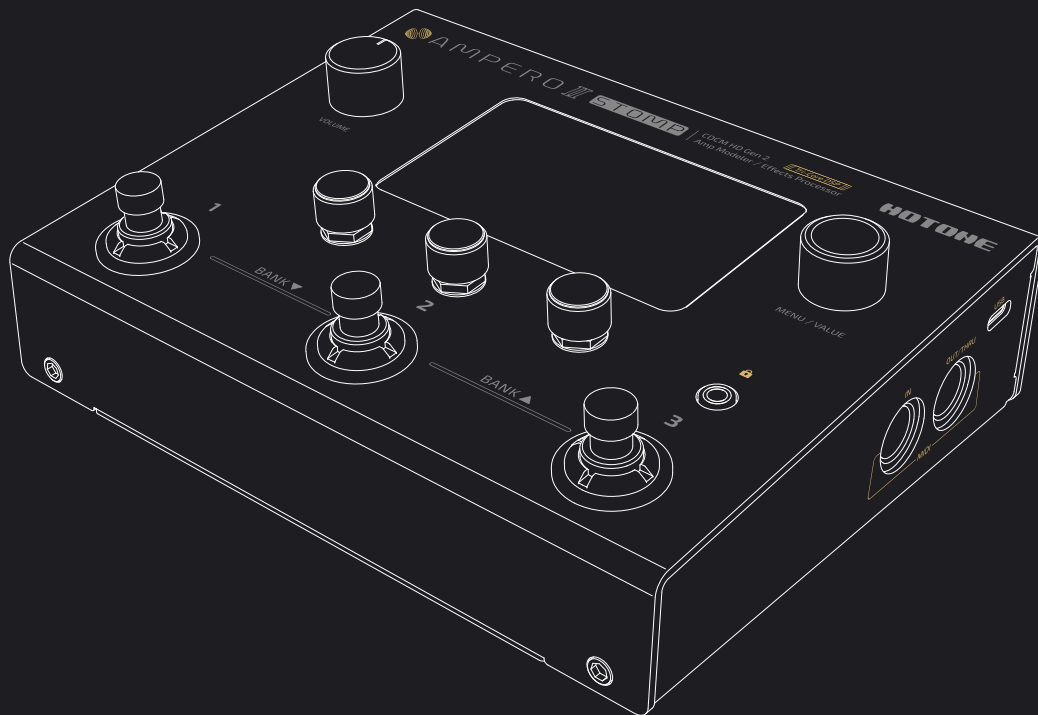

HOTONE
DESIGN INSPIRATION

In the interest of product improvement, the specifications and/or the content of products (including but not limited to appearances, packaging design, manual content, accessories, size, parameters and display screen), are subject to change without prior notice. Please check with local supplier for exact offers. Specifications and features (including but not limited to appearances, colors and size) may vary by model owing to environmental factors, and all images are illustrative.

Contents

Welcome	1	Effects List	41
Notice	1	Effect Models List	41
Definitions	2	DYN	41
Panel	3	FREQ	43
Getting Started	5	WAH	49
Main Display Screen	6	DRV	50
Using the Interface	7	AMP	54
Tools	8	PRE AMP	67
Tuner	8	CAB	79
Looper	9	IR	83
Unit Mode	10	EQ	84
Bypass	10	MOD	85
Customizing Your Ampero II Stomp	11	DLY	89
EDIT	11	RVB	95
Effects Chains Menu	11	FX SND/FX RTN/FX LOOP	96
Input Node Setup	13	VOL	96
Output Node Setup	14	MIDI Control Information List	97
Effects Chain Types	14	Troubleshooting	99
Using Effects Chain Templates	16	Technical Specifications	100
Split/Mixer Node Settings	16		
Save Effects Chain Templates	18		
Module/Effect Menu	18		
Move, Swap, Copy, Paste and Delete Modules	19		
Patch Tempo And Patch Volume	21		
Tap Tempo And Tap Divide	21		
Using FX Loop	22		
CTRL/EXP	24		
Current Settings	24		
FS Settings	24		
Quick Access Para	25		
EXP Settings	26		
Calibrate	27		
SAVE	28		
Patch Management	28		
GLOBAL	30		
I/O	30		
USB Audio	31		
Advanced USB Audio Interface Function Guide	32		
Controls	33		
MIDI Settings	34		
Global EQ	35		
Display	36		
About	36		
Factory Reset	36		
Suggested Setups	37		
Using with your instrument and amp	37		
Connecting to your amp's RETURN or Power Amp (Loudster)/FRFR cabinet INPUT	37		
Connecting pedalboards	38		
Connecting your mixer, interface, headphones, and other equipment	39		
Connecting to your computer as an audio interface	39		
Using the AUX IN line	40		
The Editor	40		

Welcome

Thank you for purchasing a Hotone product.

Please read this manual carefully to get the most out of your Ampero II Stomp.

Please keep this manual in a safe place for further reference.

Notice

Please read this manual carefully. It contains information regarding the proper use of this product and other important information.

Warning

- Do not open the casing or attempt to modify the product or power supply. Hotone will not be responsible for product damage or bodily harm should the product be tampered with.
- To reduce the risk of hearing damage, do not use headphones at high volume for an extended period of time. Should you notice discomfort, discontinue use and see a medical professional immediately.
- Children using this product should be accompanied by an adult.

Environment

Avoid using the unit in any of the following conditions that could cause malfunction:

- Extremely hot or cold places
- Near heaters and other heat sources
- Sandy or dusty places
- Places that are extremely humid or exposed to splashing water
- Places with extreme vibrations

Power Supply Safety

- In most situations, we strongly recommend to use the attached DC 18V center negative adapter.
- Always use an independent or isolated power supply for the unit due to high power consumption. Using daisy chain power connection for the unit is NOT recommended.
- When using a 3rd party power adapter, please make sure the power adapter fits the unit's power requirement. Use of an adapter other than that specified could damage the unit or cause malfunction and pose a safety hazard. Hotone will not be responsible for product damage or bodily harm should the product be tampered with.
- Do not use attached power adapter for other purposes.
- Always connect the adapter to an outlet that supplies the rated voltage required by the adapter.
- When disconnecting the adapter from an outlet, always pull the connector itself. Pulling the cable will cause damage to the unit. Make sure to separate the power adapter and store in a safe place.
- During lightning storms or when not using the unit for an extended period, disconnect the adapter from the outlet.
- Make sure your hands are dry when plugging in the adapter.

Operation Safety

- Never put objects filled with liquids on the unit as this could cause electric shock.
- Never place candles and other burning objects on top of the unit. Doing so could cause a fire.
- This unit is a precision device. Do not apply excessive force to the switches and other controls. Do not expose the unit to strong impact or drop it.
- Do not apply excessive force to the touchscreen or casing, which may cause malfunction.
- Do not place foreign objects (liquid or solid) into the product.
- The unit and power supply will become warm with extended use, this is normal.

Connections and Interference

- Turn off the unit and all other connected devices before connecting any cable to it.
- Disconnect the power supply and other line connections before moving the unit to another location.
- This unit is designed to resist external electromagnetic interference, but may produce static in some cases of strong electromagnetic interfere (e.g. high power transformers or wireless TV/phone equipment). Turn off any nearby electromagnetic equipment when using, if possible.
- Like all digital devices, this unit may experience malfunction and/or loss of data if exposed to strong electromagnetic interference. Please use caution.

Cleaning

Use a soft cloth to clean the panels if they become dirty. If necessary, slightly moisten the cloth. Never use cleansers, wax, or solvents such as paint thinner, benzene or alcohol.

Malfunction

- If the unit should malfunction, disconnect the AC adapter and turn the power OFF immediately. Then, disconnect all other connected cables. For:
 - Power adapter malfunction
 - The unit or power supply emits an odor
 - Liquids or foreign objects entered the unit
 - The unit has other obvious signs of malfunction (e.g. won't turn on, knobs won't work, won't produce sound, etc.)
- Prepare information including the model name, serial number, specific symptoms related to the malfunction, your name, address and telephone number and contact the store where you bought the unit.

Definitions

Effects Chain

The effects chain (or simply "chain") shows the current internal signal routing/effect procession including current effects chain type, signal routing, current effects and effects combination, etc.

Ampero II Stomp features two effects chains with flexible serial/parallel options.

Effect Slot

Effect slots (or simply "slots") are spaces located on an effects chain for adding effects. Ampero II Stomp features 6 slots on one effects chain, 12 slots in total.

Module

Ampero II Stomp employs 13 kinds of effects, each kind is called an "effects module," or simply "module". There are several effects available in each module. To use an effect, add a module to an empty effect slot, and then pick one effect in the module. There are also some modules used for signal routing only.

Parameter

Variables that determine the application of an effect are called "parameters". If we imagine each slot as a separate effect pedal, then each parameter would be a knob on that pedal.

Node

The beginning/end of an effects chain or the intersection of two effects chains is called a "node":

- **Input node** is the beginning of an effects chain that sets signal input source;
- **Output node** is the end of an effects chain that determines where the signal goes;
- **Split node** splits one effects chain into two, sending the signal to two effects chains;
- **Mixer node** combines two effects chains into one.

Patch

The ON/OFF status and current module/effect of each effect slot, parameter settings and related controller/expression pedal settings are stored in units called "patches". These are your "tones." Use patches to recall, edit, and save your favorite tones.

Bank

A set of 3 patches is called a "bank". Ampero II Stomp has a total of 100 banks, which means, you have up to 300 fully editable/savable patches. If you made a factory reset, the first 99 patches (factory preload patches) will be restored.

Panel

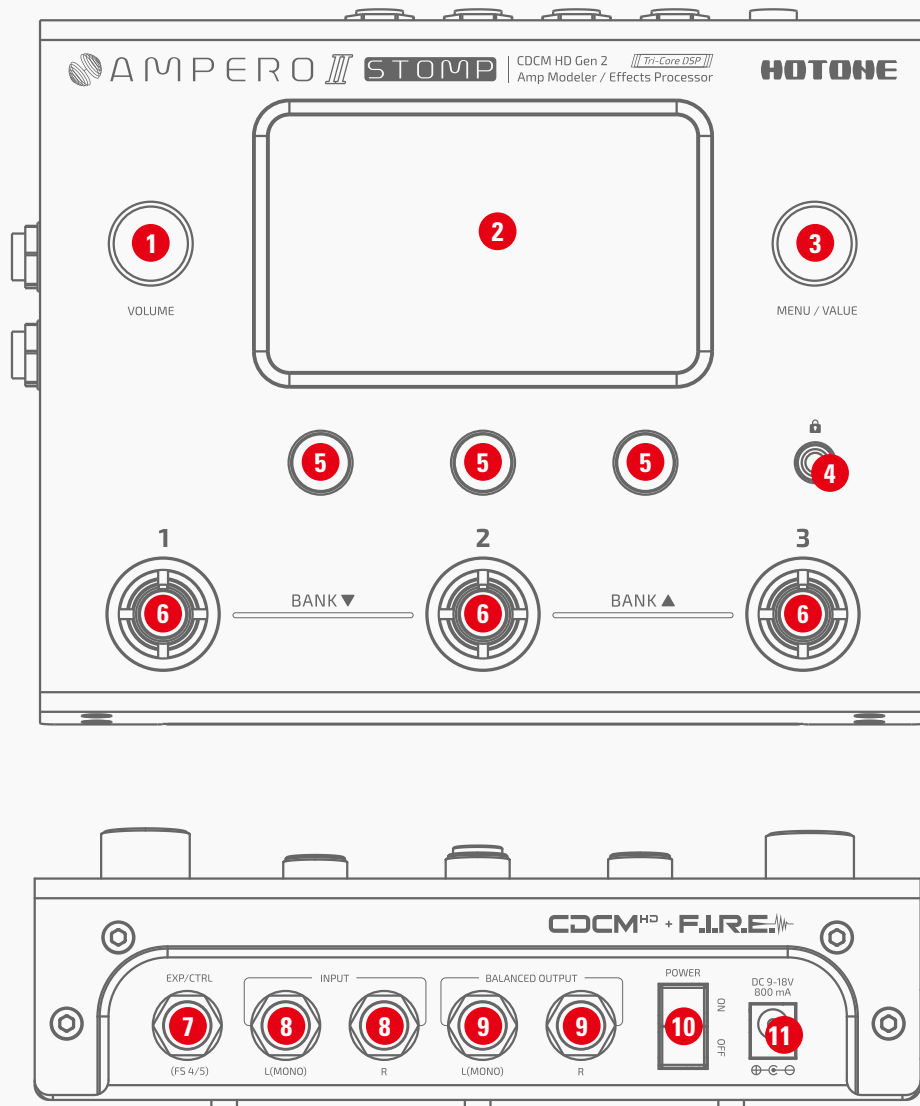

- 1. VOLUME Knob:** Adjusts the overall volume of output and headphones output connections.
- 2. Display Screen:** Displays unit current status. Use the touchscreen to select effects, edit patches, and make tone adjustments.
- 3. MENU/VALUE Knob (Main Knob):** Turning or pressing this knob allows you to change menus and adjust parameters.
- 4. Screen Lock Button:** Used to lock or unlock the touchscreen.
- 5. Quick Access Knobs 1-3 (left to right) :** Used to adjust parameters on the lower part of the screen. Each knob will vary in function according to the parameter on the display.
- 6. Footswitch:** Used to change patches, turn on/off effects, set tap tempo, etc.
- 7. EXP/CTRL:** 1/4" TRS input, for connecting an external expression pedal/momentary footswitch controller. Perfect for Ampero Press or Ampero Switch.
- 8. INPUT:** 1/4" unbalanced stereo input connections for guitar or other instrument.
- 9. BALANCED OUTPUT:** 1/4" balanced stereo TRS output connections to instrument amp, effects pedal, mixer, audio interface, etc. For mono output, use only the left output.
- 10. POWER Switch:** Turns power on/off.
- 11. Power Supply Connection:** Power supply input (9-18V DC center negative). We strongly recommend **always use the included genuine power adapter.**

Panel

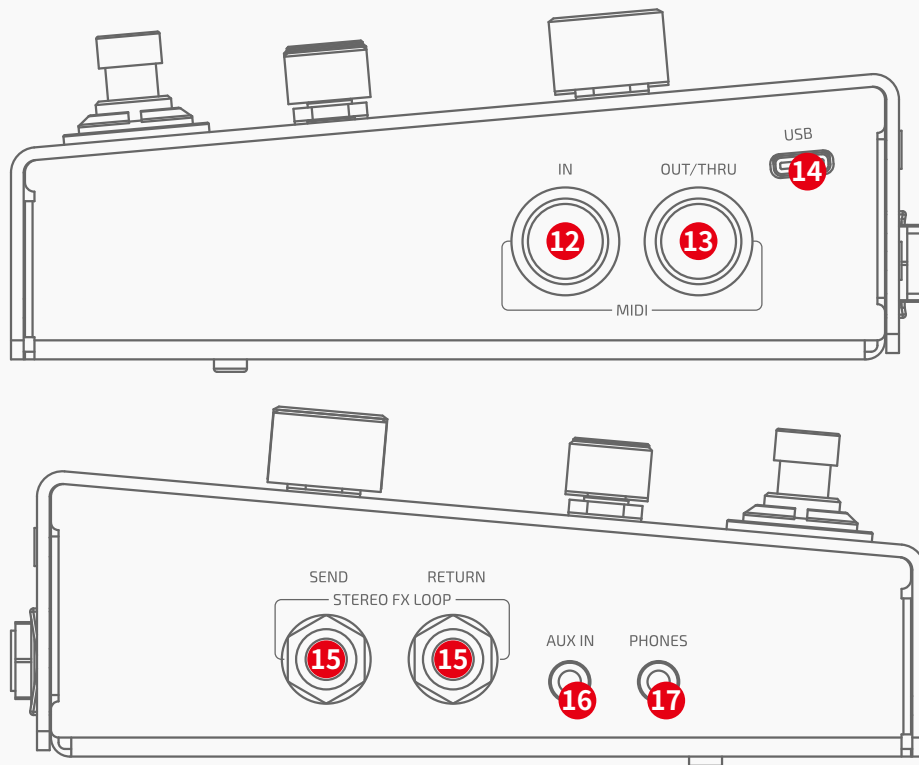

12. MIDI IN: Standard 5-pin MIDI IN for receiving MIDI messages or connecting a MIDI controller. Perfect for Ampero Control.

13. MIDI OUT/THRU: Standard 5-pin MIDI OUT for sending/transferring MIDI messages.

14. USB: USB 2.0 Type-C for connecting to your computer.

15. STEREO FX LOOP: 1/4" unbalanced stereo TRS input/output connections:

- **SEND:** 1/4" unbalanced stereo TRS output jack, for feeding signal to other devices
- **RETURN:** 1/4" unbalanced stereo TRS input jack, for receiving signal from other devices. When you need stereo connection, a Y cable is needed for connector separation/combination:

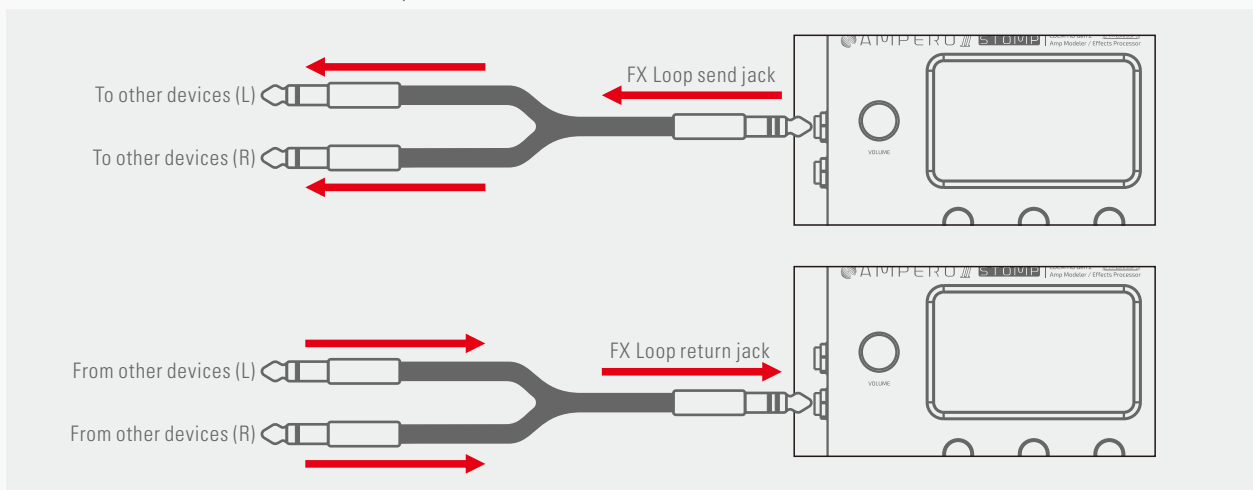

16. AUX IN: 1/8" stereo input for connecting external devices (phone, MP3 player) for practice and jamming.

17. PHONES: 1/8" stereo output for connecting headphones.

Getting Started

1. Connecting your Device

Plug your guitar in to the Ampero II Stomp's input jack and run a cable from OUTPUT L to your amp.

Please remember:

- (1) Keep your amp and unit volume down.
- (2) Connect your cable to the amp's FX Loop Return if it has one (see Suggested Setups section on [page 37](#)).
- (3) When using with studio monitors, we suggest to use a stereo pair of monitors for best possible experience. Remember to turn monitor power off or turn monitor volume down before connection to prevent from possible device damage/hearing loss.
- (4) When using with headphones, we suggest to use studio monitor headphones for best possible experience. Headphones with built-in microphone are not recommended – the TRRS connector may not be correctly recognized due to different manufacturers, which may lead to malfunction.

2. Connect the power supply and turn ON.

- ## 3. Select GLOBAL to enter Global Menu, select I/O and find Input Mode. Select a correct input mode based on what kind of instrument you have: E.GT for electric guitar or bass, A.GT for acoustic instruments, Line for keyboards. For stereo inputs, you need to set both L/R inputs. The default is set to E.GT, which means, in most situations/scenarios, you don't need to change it.



- ## 4. Tune your guitar. Press and hold footswitch 1 until the TUNER comes on the display screen (see Tuner section on [page 8](#)). Pluck each string and tune until the pitch reaches the middle of the screen and turns green, as below:

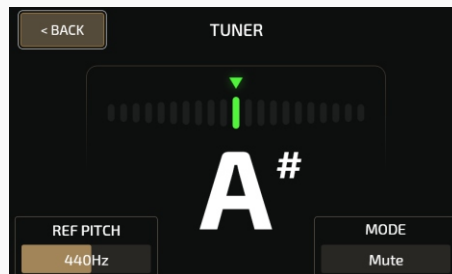

When finished, tap any footswitch to exit the tuner.

5. Select a patch:

- Tap footswitch 1, 2, or 3 to choose a patch you like.
- Tap footswitches 1 and 2 together to move backward through the banks. Tap footswitches 2 and 3 together to move forward through the banks.
- In default settings, when switching banks, the unit will stay in the previous patch you're using (called Wait Mode); you need to tap one footswitch again to confirm patch selection.

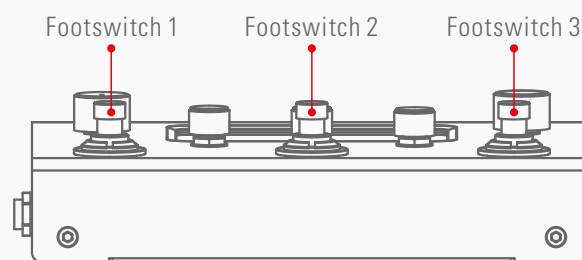

Main Display Screen

When the unit is turned on, it will display the main screen, as shown below:

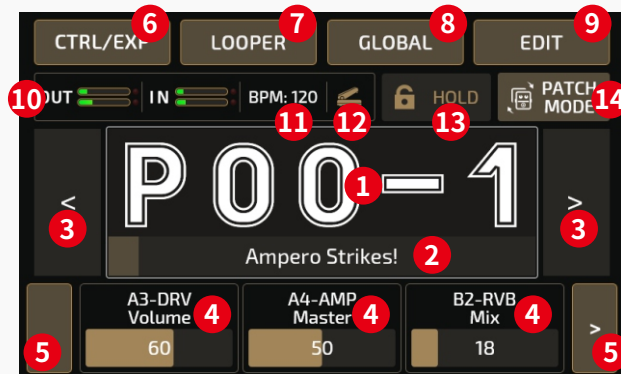

1. Current patch number; press to enter patch list (see Patch Management section on [page 28](#))
2. Current patch name; slide on the bar to go through the patches. Current patch number and name may swap depending on your settings (see Display section on [page 36](#))
3. Patch selection forward/back button
4. Parameter list: This shows current parameters controlled by quick access knobs 1-3. In main menu, this indicates quick access paras of current patch; hold the parameter name to change the parameter you're controlling (see CTRL section on [page 24](#))
5. Next page button to go to next page of parameter list: In main menu, this allows you to see current footswitch functions and LED colors:

In Stomp Mode (press 14 to switch between modes), you can use quick access knobs to change footswitch function:

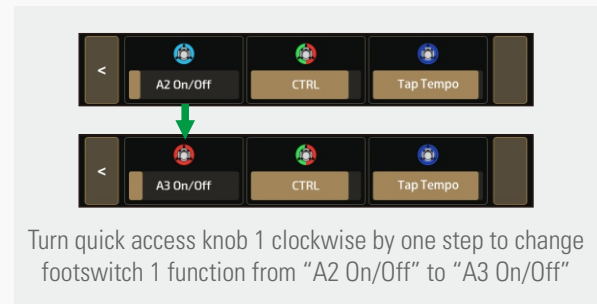
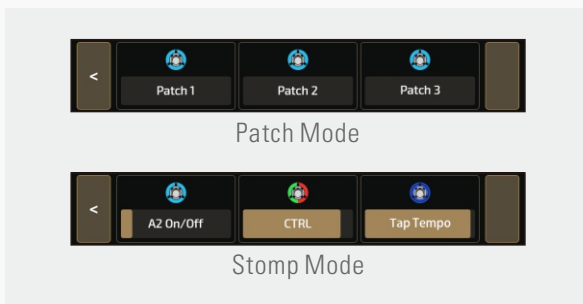

Turn quick access knob 1 clockwise by one step to change footswitch 1 function from "A2 On/Off" to "A3 On/Off"

6. CTRL/EXP gives you access to control settings (see CTRL/EXP section on [page 24](#))
7. LOOPER gives you access to looper menu (see LOOPER section on [page 9](#))
8. GLOBAL opens the global settings page (see GLOBAL section on [page 30](#))
9. EDIT allows you to edit the current patch (see EDIT section on [page 11](#))
10. Leveling meter that indicates current I/O level:

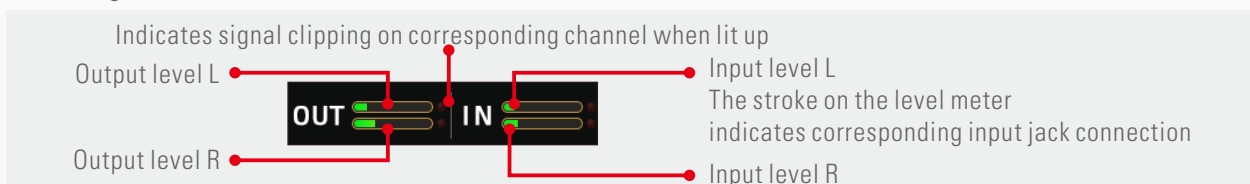

11. Indicates the current patch tempo; press to enter patch tempo:



12. Indicates external expression pedal status (lit up when on, gray when off); press to switch pedal status
13. Indicates screen lock status; hold to lock screen
14. Indicates current unit mode; press to switch between PATCH MODE and STOMP MODE (see Unit Mode section on [page 10](#))

Using the Interface

Touch operation

Changing patches and editing settings can all be done with the touchscreen:

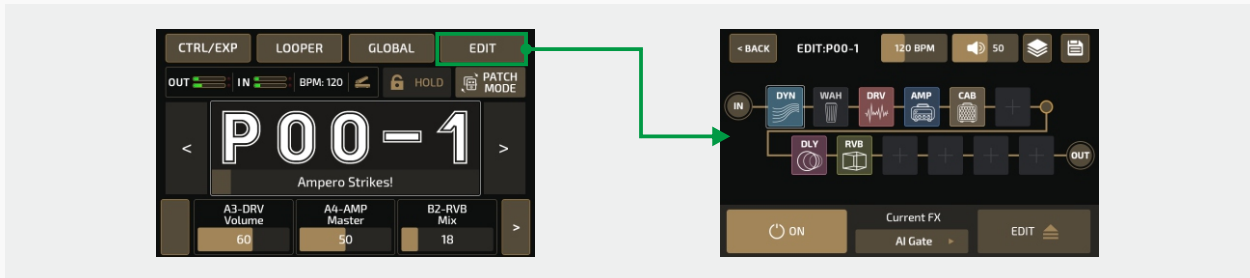

Sliding on one parameter in parameter list to adjust:

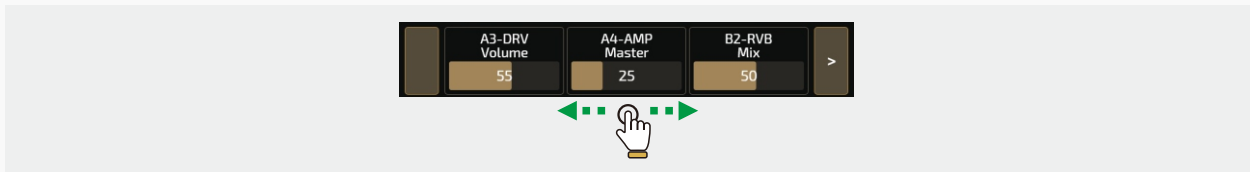

Buttons indicates there are more parameters to be shown. Press to go to previous/next page to check them out:

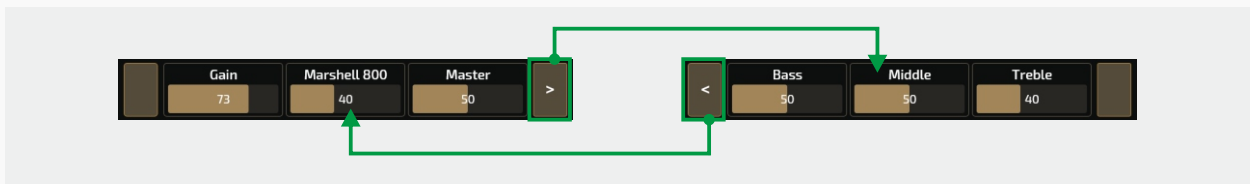

Quick Access Knobs

The quick access knobs allow you to change the values of the three parameters directly above on the touch screen.

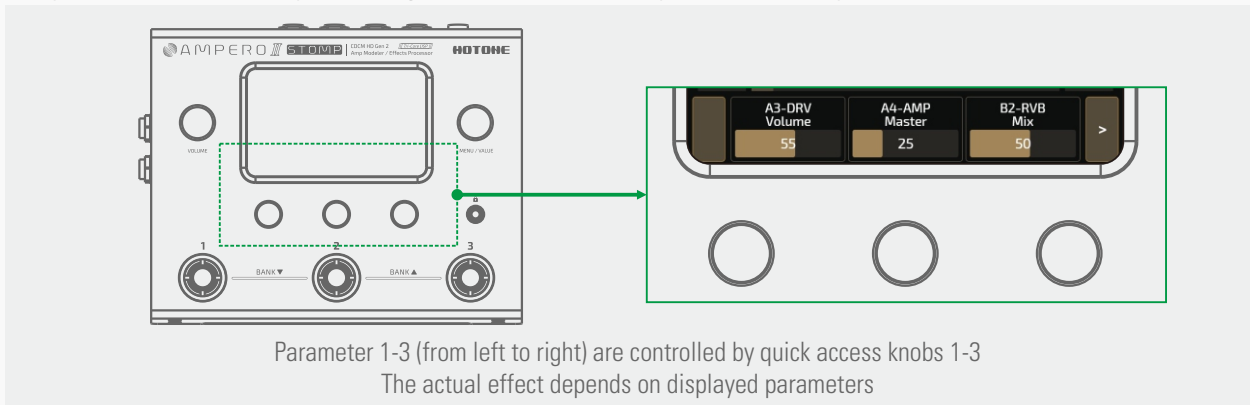

Main Knob

Turning the main knob lets you select the object you want to control:

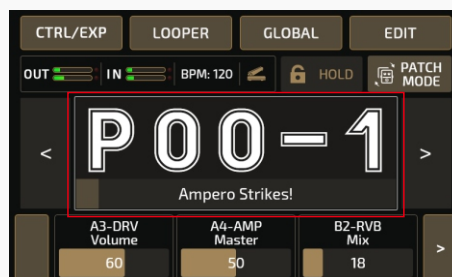

The white square indicates current cursor location

Using the Interface

Then press the knob to confirm the selection:



The gold square indicates the patch number is selected
Turn Main Knob to go through the patches

- If the object selected is a button, it will respond as if you'd touched the button on the touchscreen.
- If the object selected is a parameter, you can use the main knob to adjust the parameter value. Pressing the main knob again will take you back to selection mode.

Please note:

The details of use and programming may slightly vary under certain operational circumstances. Please read this manual carefully to get all the necessary information.

Tools

In this section you'll know how to:

- Use Ampero II Stomp's tuner and looper
- Set a proper unit mode depending on your needs
- Bypass Ampero II Stomp like a pedal

Tuner

Hold footswitch 1 to open the tuner.

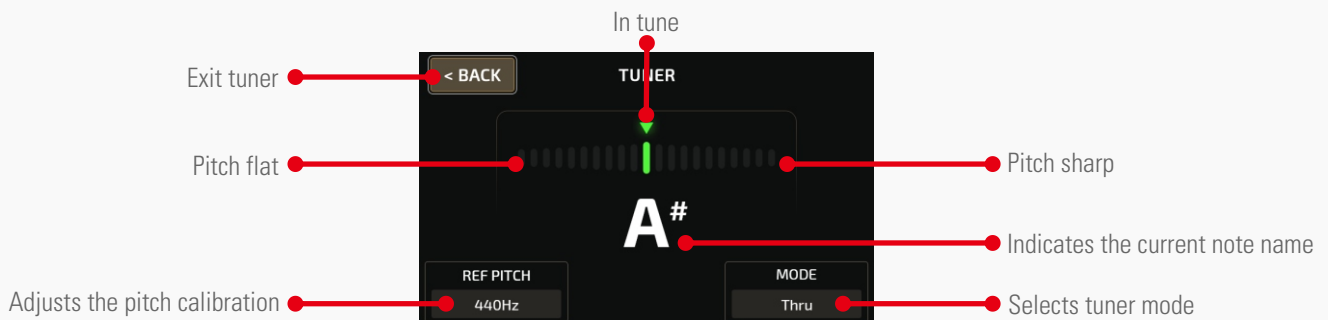

On the upper part is a scale that indicates your pitch. Left of center is flat, and right of center is sharp. As you tune your instrument towards the middle, the color of the scale will change from red (out of tune) to yellow (near pitch) to green (in tune). Quick access knob 1 adjusts the pitch calibration (REF PITCH), ranging from 415Hz to 475Hz. Standard pitch is set at 440Hz. Quick access knob 3 lets you select the tuner mode:

- Thru (for effect signal through)
- Bypass (for dry signal thru)
- Mute (for silent tuning).

You can exit the tuner either by pressing any footswitch or by pressing the Back button on the touchscreen.

Tools

Looper

Hold footswitch 2 or press LOOPER button in main menu to open the looper menu.

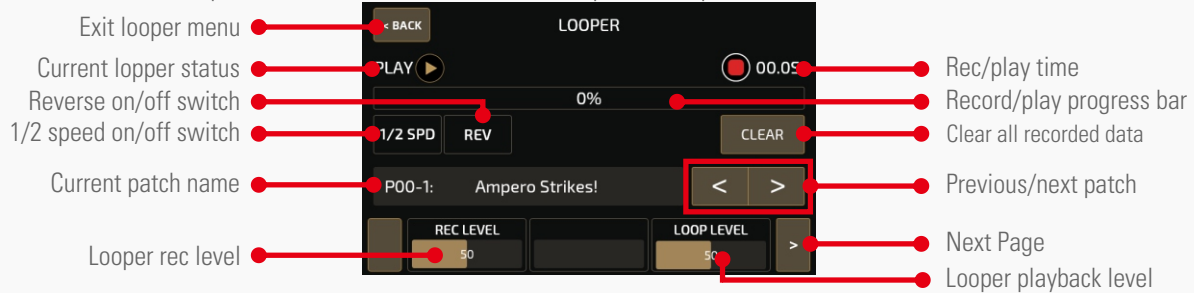

The progress bar at the top will be shown in red during recording and overdubbing. It will be shown in green during playing.

In default settings, use footswitch 1 to record/play/overdub, footswitch 2 to undo/redo, footswitch 3 to stop/clear all recorded data.

Footswitch 1 controls start (yellow LED) and stop (yellow LED) for half speed playback. Footswitch 2 controls the start (magenta LED) and stop (magenta LED) for reverse playback. These footswitch controls correspond with the 1/2 SPD and REV buttons on the touchscreen.

In page 1:

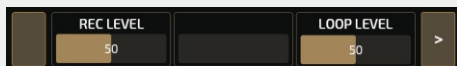

Quick access knob 1 adjusts the loop recording level (0-100).
Quick access knob 3 adjusts the loop playback level (0-100).

Go to page 2 for further settings:

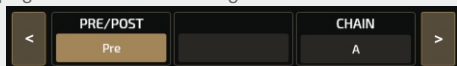

Quick access knob 1 selects between setting the loop before (Pre) or after (Post) your effects chains. The maximum recording time is 60 seconds in both modes.

- In Pre mode, the looper will record stereo audio without any effects
- In Post mode, the looper will record stereo audio with effects

Quick access knob 3 selects between setting the loop in chain A or chain B.

Go to page 3 for further settings:

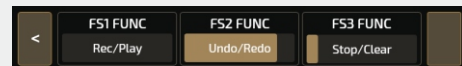

The FSX FUNC (X=1-3) allows you to assign footswitch functions in looper menu. The functions can be:

- Rec/Play: Tap to recording, then tap again to start playback
- Stop/Clear: Tap to stop recording and hold to clear
- FX: Tap to toggle 1/2 speed function, hold to toggle reverse function (violet LED steady)
- 1/2 SPD: On (yellow LED on)/Off yellow LED off)
- REV: On (white LED on)/Off (white LED off)
- Undo/Redo: Tap to undo/redo last overdub phrases (blue LED steady)
- Looper Exit: Exit looper page

Exit the looper by pressing BACK on the upper left of the screen. The current looping status won't be affected.

Looping operation and status modes:

Operation	Function/Status	LED Color (Rec/Play)	LED Color (Stop/Clear)
On with no data	Stop	None	None
Tap Stop/Clear footswitch while loop is playing	Stop	Flashing green	Flashing green
Tap Rec/Play footswitch when there's no data	Record	Steady red	None
Tap Rec/Play footswitch while recording, overdubbing, or paused	Play	Steady green	Steady green
Tap Rec/Play footswitch while loop is playing	Overdub	Steady blue	Steady blue
Hold Stop/Clear footswitch	Clear	Quickly flashing green	Quickly flashing green
Each time a recorded loop plays from the beginning	Play	Single flash	Single flash
Tap Undo/redo footswitch during playback	Undo/redo	Steady green	Steady green

Please note:

1. When the loop recording reaches its time limit, the looper will automatically stop the recording and begin playback.
2. When the looper is in Post mode, changing patches will not change already recorded loop phrases.
3. Half-speed and Reverse functions will affect all recorded loop phrases.
4. If you switch looper between pre/post while it's running, the loop will automatically stop and be erased; switching A/B won't affect looping data and status, but the output may differ depending on effects chain and pre/post settings.

Tools

Unit Mode

Hold footswitch 3 or press  button in main display to switch between Patch and Stomp modes.

Patch Mode

- A “classic” mode friendly for most multi-effects users
- Recommended to users who are new to Ampero II Stomp or who prefer classic operations
- In this mode, footswitch function is fixed; one of the footswitch LEDs will be cyan steady to indicate selected patch
- Use footswitch 1-3 to select between patch 1-3 in the current bank
- Press footswitch 1+2 to go to previous bank, footswitch 2+3 to go to the next bank
- In default settings, Ampero II Stomp features Wait Mode when switching banks: in this mode, the unit will stay in the current patch (footswitch LED will keep flashing) until you choose another by tapping a footswitch
- To change bank select mode, check Controls section ([page 33](#)) for details

Stomp Mode

- Recommended to users who prefer pedalboard-like operations
- In this mode, footswitch function and LED color depend on your footswitch settings (see CTRL section on [page 24](#)); you can use the footswitches to toggle effects on/off, tap tempo, etc.
- Press footswitch 1+2 or 2+3 to activate bank select status: the bank will remain unchanged, so you can choose another patch in the same bank
- In bank select status, current patch number/patch name (depending on display mode settings) will be stressed, as shown below:



- In bank select status, press one footswitch to choose a patch, press footswitch 1+2 to go to previous bank, footswitch 2+3 to go to the next bank; the unit will stay in the current patch (footswitch LED will keep flashing) until you choose another patch by tapping a footswitch
- Choosing a new patch will deactivate bank select status and footswitch functions will go back to normal

Bypass

In Patch Mode, you can press on a footswitch corresponding to the current patch to bypass the unit (e.g. in P00-2, press footswitch 2 to bypass the unit):

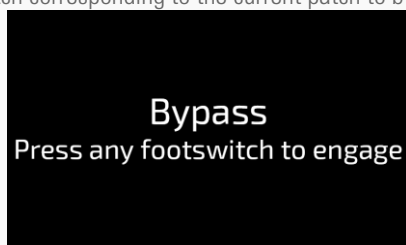

When the unit is bypassed, press any footswitch to go back to normal.

Ampero II Stomp supports two bypass modes: DSP Bypass and Analog Bypass. You can set unit bypass mode depending on your needs (see GLOBAL section on [page 30](#)).

Please note:

1. Bypassing the unit will also bypass USB Audio.
2. Ampero II Stomp features a hardware true bypass in Analog Bypass mode, which supports mono in/out, stereo in/out configuration only (mono in/stereo out not supported).
3. In Analog Bypass mode, the phones output will be MUTED when bypassed.

Customizing Your Ampero II Stomp

This section will show you how to customize your Ampero II Stomp's settings, edit patches, setup the expression pedal, and change other features to your taste.

EDIT

Edit your patches to get the tone you want.

Remember that turning the effect slots on/off and adjusting parameters will change the current patch. If you switch patches or turn the unit off before saving your changes, the changes will be lost. Make sure to press **SAVE** on the upper right of the display screen to save your settings.

So select a patch first:

Select a patch from the main menu by using the forward/backward arrows on the screen. Scroll back (press 1 and 2 together) or forward (press 2 and 3 together) through banks using the footswitches.

Enter the patch list menu by pressing patch number in main menu to choose a patch directly.

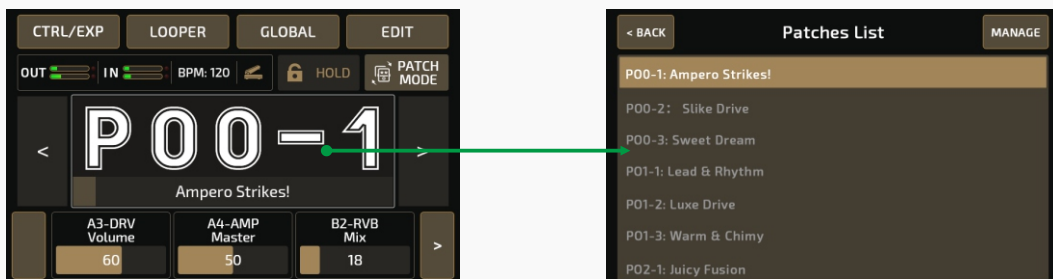

You can also start with an empty patch (P33-1 to P99-3 in default).

Effects Chains Menu

In main menu, press EDIT to enter the effects chains menu:

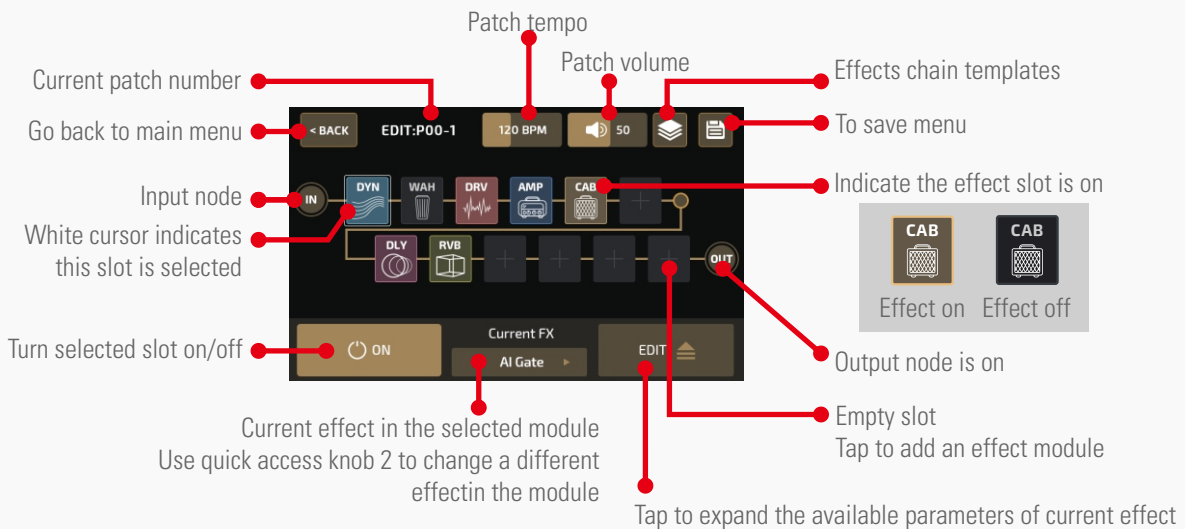

The menu shows how your Ampero II Stomp processes your sound by showing internal signal flow, effect combination, etc.

Now let's see detailed effects chain info:

Customizing Your Ampero II Stomp

Effects Chain Basics

The upper effects chain is called effects chain A (or simply "chain A"), the lower chain is called effects chain B (or simply "chain B"):

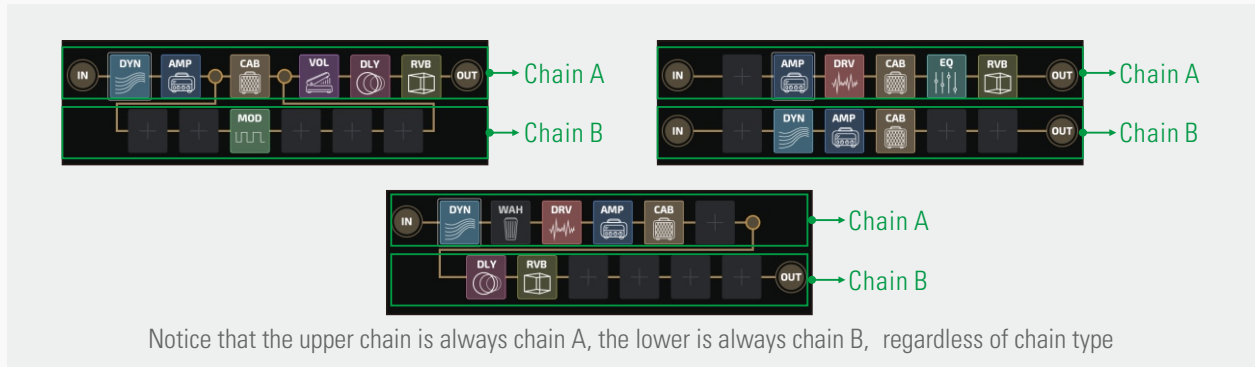

The signal flow direction is fixed from left to right:

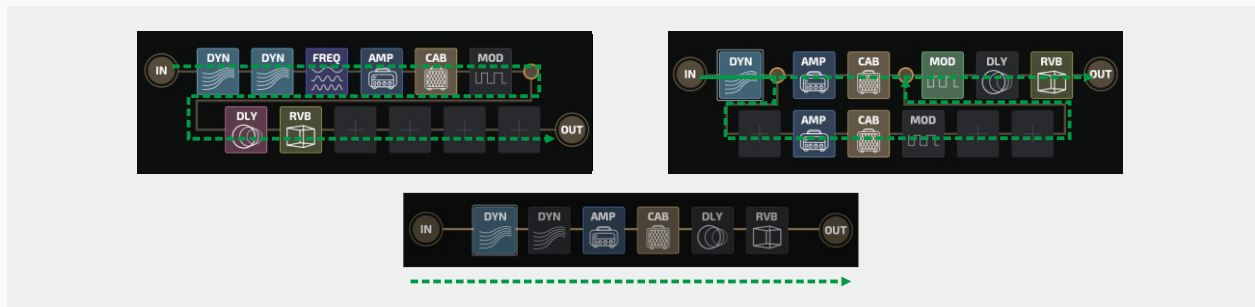

Nodes

The beginning/end of an effects chain or the intersection of two effects chains is called a "node":

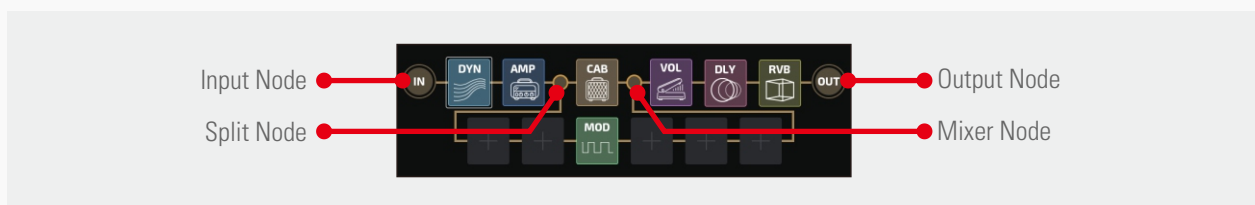

- **Input node** is the beginning of an effects chain that sets signal input source
- **Output node** is the end of an effects chain that determine where the signal outputs to
- **Split node** separates one effects chain into two and sends separated signals in a certain way that determined by node settings, appears on chain A only
- **Mixer node** mixes two effects chains into one and outputs in a certain way that determined by node settings, appears on chain A only

Effect Slots

Effect slots (or simply "slots") are spaces located on an effects chain for adding effects. Ampero II Stomp features 6 slots on one effects chain, 12 slots in total. Slot numbering is shown below:

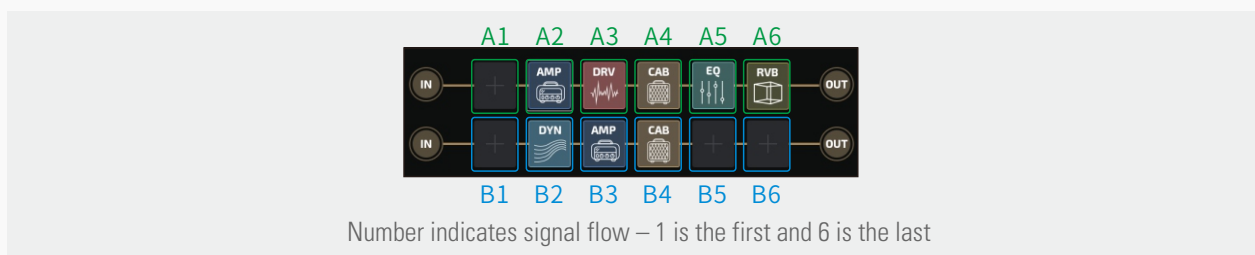

Customizing Your Ampero II Stomp

Modules

A blank effect slot is just like a short cable that have no effect on your tone. So, if you want to start your tone sculpting, you need to add an effect module (or simply "module"), and pick one effect contained in the module.

Ampero II Stomp features 13 effects modules as listed below:

- DYN: Dynamic effects like compressor, boost, noise gate, etc.
- FREQ: Filter-based effects like low/band/high pass filter, envelope/auto filter, pitch shift/detune, octave, etc.
- WAH: Wah pedal
- VOL: Volume pedal
- DRV: Overdrive and distortion
- AMP: Amp modeling effects
- PRE AMP: Preamp effects incl. acoustic/bass preamps
- CAB: Cabinet simulations
- IR: For loading built-in factory IRs (incl. acoustic IRs) and user Irs
- EQ: Equalizers
- MOD: Modulation effects
- DLY: Delay effects
- RVB: Reverb effects

There are also 3 FX Loop related modules:

- FX SND: FX loop send module for sending signal to external devices via unit's FX loop send jack
- FX RTN: FX loop return module for receiving signal from external devices via unit's FX loop return jack
- FX LOOP: FX loop module for inserting external effects to an effects chain via unit's FX loop jacks

Effect Slot Status

There are three slot status shown as below:

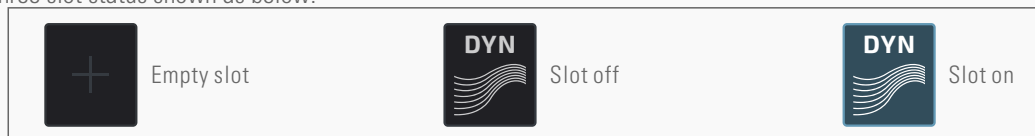

- **Empty slot** - the slot acts like a cable
- **Slot off** - the slot is bypassed, and the module in the slot doesn't work
- **Slot on** - the slot is on, the module in the slot is working

The next texts will show you how to edit an effects chain.

Input Node Setup

Select an input node and the parameters will come up as shown below:

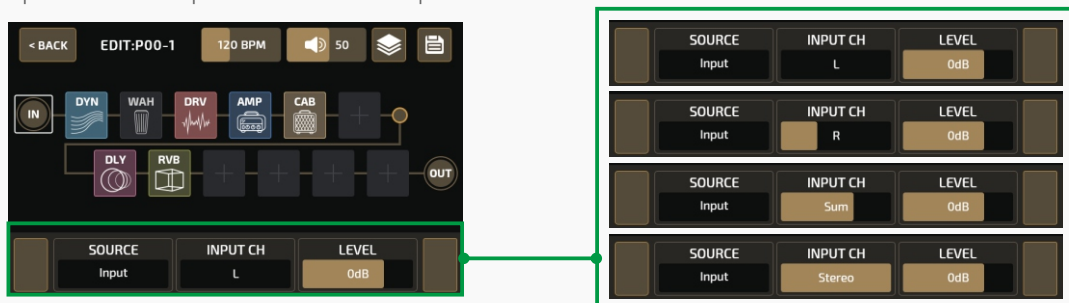

SOURCE lets you select an input signal source of current effects chain:

- Input: Sets the effects chain input source to the unit's input jack
- FX RTN: Sets the effects chain input source to unit's FX loop return jack
- USB 3/4-7/8: Set the effects chain input source to USB audio output 3/4-7/8, which is convenient for reamping (check USB Audio section on [page 31](#) for details)

Customizing Your Ampero II Stomp

There are two selections available for **chain B only**:

- None: no input, then chain B will turn gray to indicate chain B not working:

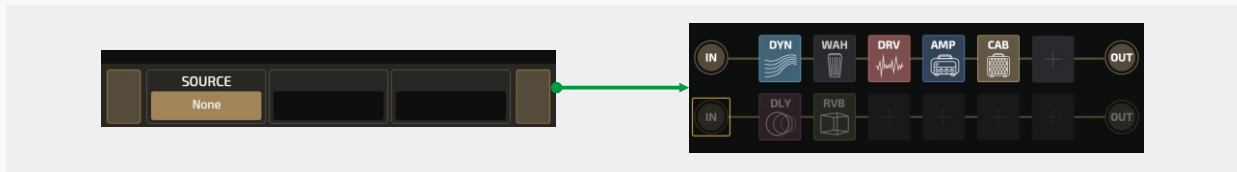

- Chain A: Receives outputs from chain A, in this case, the chain A and B connects in series (see **Effects Chain Types** section on [page 14](#) for details):

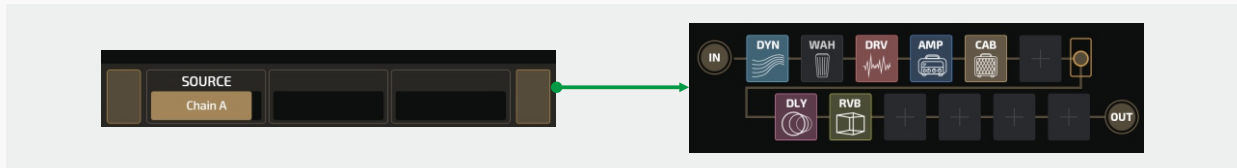

INPUT CH lets you select the signal input channel:

- L/R: For FX loop return jack, the left channel is connected to tip conductor and the right channel is connected to ring:

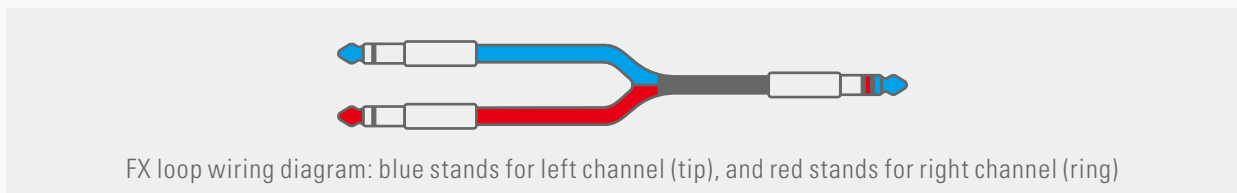

For USB outputs, even number stands for left channel (3, 5, 7) and odd number stands for right channel (4, 6, 8)

- Sum: Sums input signal to mono
- Stereo: Receives L/R stereo inputs

LEVEL lets you adjust input level from Mute~-60dB~+20dB. Default is set to 0dB (unity gain).

Output Node Setup

Select an input node and the parameters will come up as shown below:

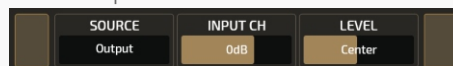

OUTPUT TO lets you decide where the output signal goes:

- Output: Sets the signal output to unit's output jacks (and phones jack)
- FX SND: Sets the signal output to unit's FX loop send jack
- Chain B: For chain A only, which lets you connect chain A and B in series (see **Effects Chain Types** section on [page 14](#) for details)
- None: For chain B only, in this case, chain B's output node won't work

OUT LEVEL lets you adjust output level from Mute~-60dB~+20dB. Default is set to 0dB.

PAN lets you adjust output signal stereo panning. The range is L50~Center~R50, default is set to Center.

Note: When you set **OUTPUT TO** to **FX SND**, the VOLUME knob will not work. In this case, use **OUTPUT LEVEL** to control the output volume.

Effects Chain Types

Ampero II Stomp supports various effects chain types:

Parallel

The chain A and B are fully parallel (won't affect each other). When you load an empty patch, the default effects chain type is a special parallel state that only chain A is working.

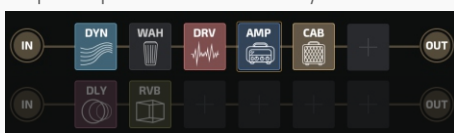

Split-Mix

An input signal will be split into two and sent to both chain A and B, then mixed into one and sent to one output:

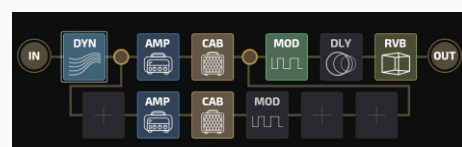

Customizing Your Ampero II Stomp

Y-A/B

An input signal will be split into two and routed to two outputs via both chain A and B:

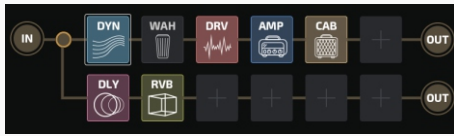

A/B-Y

Two signal inputs will be mixed into one and sent to one output:

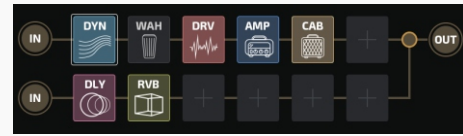

Serial

Chain A and B are connected in series (head to tail):

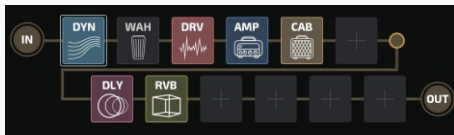

The touch screen lets you easily change effects chain types within a few taps and drags. Next we'll take parallel type as an example to show how to change chain types:

Change To A/B-Y

Drag and drop output node of chain B on chain A depending on your needs:

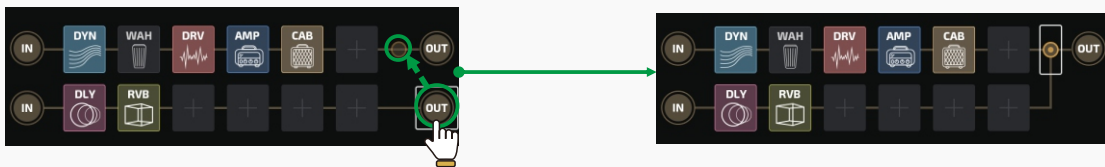

Change To Y-A/B

Drag and drop input node of chain B on chain A depending on your needs:



Change To Serial

Drag and drop input node of chain B to the output node of chain A:



Change To Split-Mix

Drag and drop input and output nodes on chain A (between input and output nodes) depending on your needs:

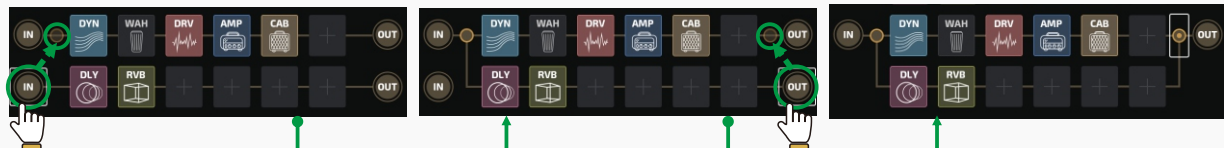

You can also operate by using Main Knob:

Turn Main Knob to a node – hold Main Knob to “pick up” a node – turn Main Knob to move the node to a place on chain A you need – press Main Knob to “put down”

Customizing Your Ampero II Stomp

Using Effects Chain Templates

You can load built-in effects chain templates for quick setup, or save all your current effects chain settings (incl. chain type and node settings) as a user effects chain template.

Press  button and the effects chain template menu will appear:

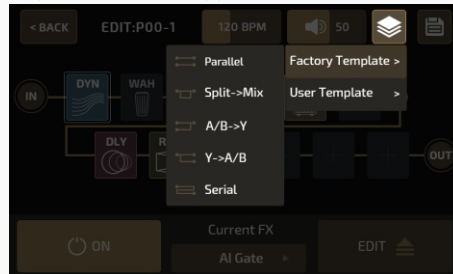

Factory Template submenu lets you choose from one effects chain type mentioned above. In factory templates, all split nodes are set between input node and slot A1, all mixer nodes are set between slot A6 and output node; all node settings are set to default. User Template lets you choose from one of five user templates (see Save Effects Chain Templates section on [page 18](#)):

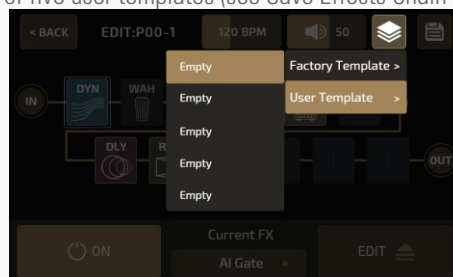

All templates are global data that won't change when changing patches. You can load them anytime in any patch.

Split/Mixer Node Settings

When using two chains, for best possible result, you need to carefully setup split and mixer nodes. The texts next will show you how to setup split and mixer nodes.

Split Node

Select a split node and the parameters will come up as shown below:

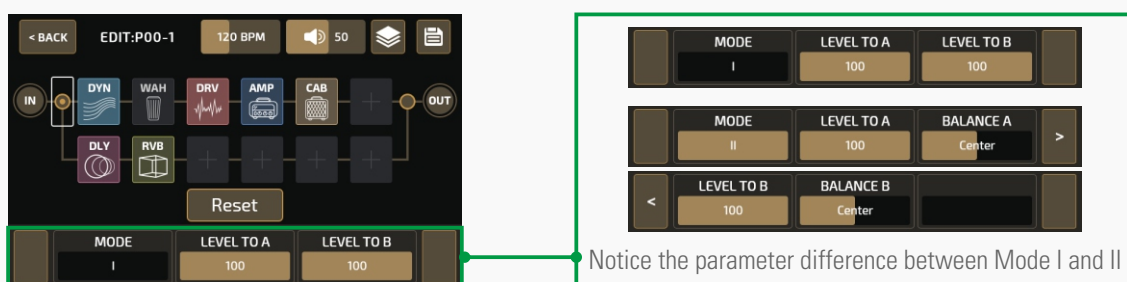

MODE lets you select a signal separation mode:

• Mode I

In this mode the split node outputs same signals to both chain A and B as node input signal. If the split node is between slots containing effects with same signal I/O processing (all mono or stereo effects), this mode is recommended.

Use **LEVEL TO A/B** to set output level to A/B chains from 0~100, default is set to 100.

Please note:

If you're mixing mono/stereo effects in slots around split node, the actual output may differ from what you expected. For example, use a stereo delay in the slot right before the split node with different delay settings on L/R channels, then use two mono filters in the slots right next to split node on both A/B chains, the result is you can only hear the delay settings on left channel. This is because effects with mono input use **left channel of input signal ONLY**.

For detailed signal I/O processing, please check **Effects List** ([page 41](#)).

Customizing Your Ampero II Stomp

• Mode II

In this mode the split node will convert node input signal into dual mono signal and send it to both chain A and B. If the split node is between slots with mixed mono/stereo effects (e.g. one stereo effect in the slot right before the split node, two mono effects in slots right next to the split node on both chains for processing L/R outputs of the stereo effect), this mode is recommended.

Use **BALANCE A/B** to set output signal content (L/R ratio of node input signal) from L50 ~Center~R50, default is set to Center. Fine tune the parameter depending on your needs:

- BALANCE set to L50/R50 means only left/right channel of input signal will be sent to the slots next to split node
- BALANCE set to a value in between means a mixed signal will be sent to the slots next to split node; the value sets the mixing ratio, set to Center means mixing ratio=1:1

Use **LEVEL TO A/B** to set output level to A/B chains from 0~100, default is set to 100.

Please note:

Setting split node to Mode II only will NOT lead to a result like “left output is a kind and right is another”, since extra output/mixer nodes settings are needed.

Mixer Node

Select a split node and the parameters will come up as shown below:

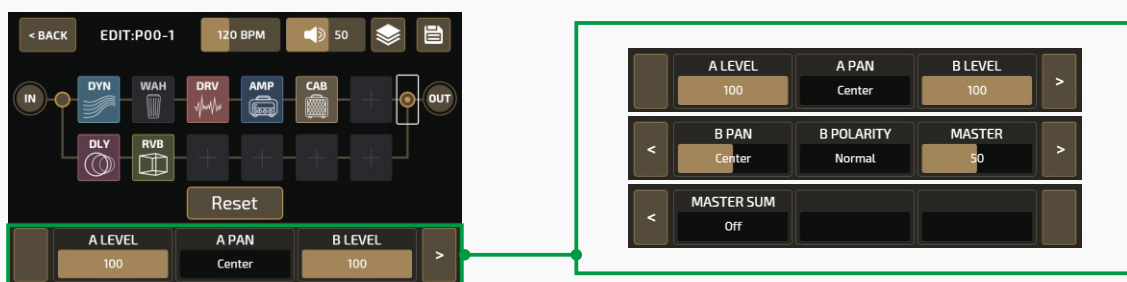

Use **A/B LEVEL** to set input level from A/B chains. The ranges are all 0~100, defaults are all set to 100.

Use **A/B PAN** to set input signal stereo panning from A/B chains. The ranges are all L50~Center~R50, defaults are all set to Center.

When you mix A/B chain signals, output may sound very sharp/thin/weak/muddy, even left and right outputs are L/R not balanced, this may be caused by signal phase issue. If mixed output sounds abnormal, you can set **B POLARITY** to reverse chain B signal phase and see if the problem solved or not. **B POLARITY** is set to Normal by default. Sometimes reversing chain B's phase may surprise you.

Use **MASTER** to set output level of mixer node. The range is 0~100, default is set to 50.

Turn on **MASTER SUM** switch to sum mixer node output to a dual mono output. Default is set to Off.

Please note:

1. When using stereo effects, in some cases, turning on MASTER SUM may lead to an abnormal output or even no output, this may be caused by L/R phase cancellation.
2. Please adjust A/B LEVEL and MASTER carefully to prevent signal clipping.

Customizing Your Ampero II Stomp

Save Effects Chain Templates

You can save a group of effects chain settings (chain type and node settings, slots/modules/effects are not included) as a user effects chain template so that you can recall anytime in any patch.

Press button and the save menu will appear:

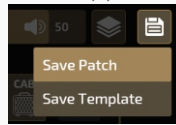

Select Save Template to save your current effects chain settings as a template:

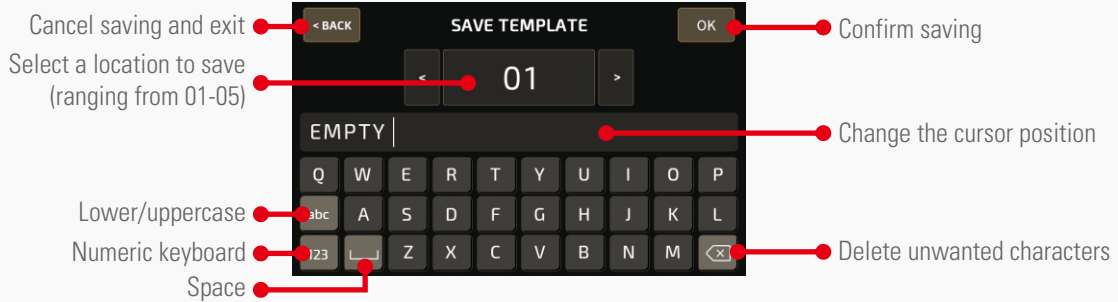

Input a template name, confirm, and done

You can find the saved templates by pressing Templates menu () and select User Template

Module/Effect Menu

Module/Effect Settings in Module/Effect Menu

Press any empty effect slot to enter module/effect menu. This lets you add a module to a slot.

Select a slot with module, press current effect name to change module/effect type:

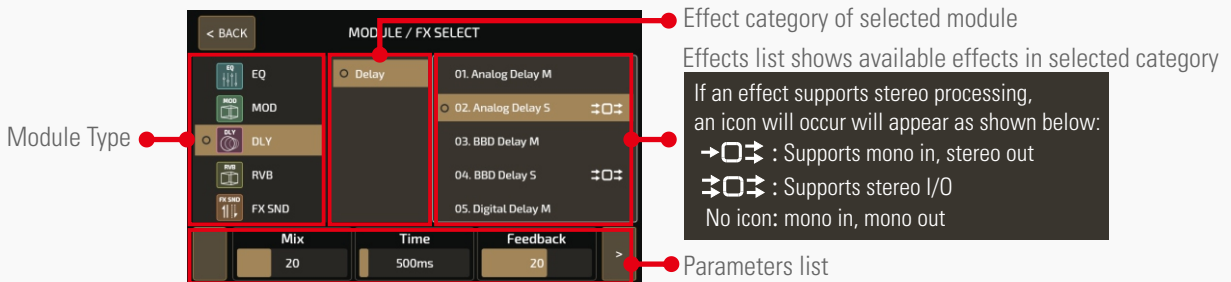
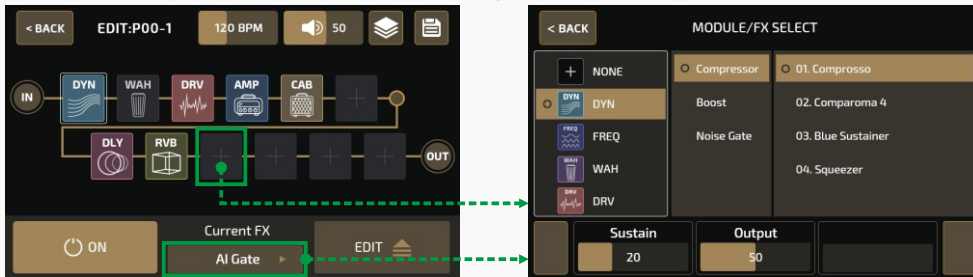

As shown above, you can choose an effect by selecting a module - choosing a category – choosing an effect. In this menu, you can directly adjust selected effect parameters and change effects types.

Use the three quick adjust knobs to adjust the parameters directly above the knobs. If there are no parameters corresponding to a certain knob, turning that knob will have no effect.

If the selected effect has more than three adjustable parameters, there will be an arrow at the right of the parameter panel. Press the arrow to see the other parameters.

In module/effect menu, you can't turn current slot on/off.

For more information on modules, effects, and parameters, refer to **Effects List** on [page 41](#).

Please note:

Different effects have different processor power requirements. So, as more and more modules/effects are added, some of the module/effect names will turn grey and become unavailable. This indicates **remaining processor power is not enough to handle these modules/effects**, which is normal.

Customizing Your Ampero II Stomp

Effects Settings in Effects Chains Menu

You can switch effects slots on/off, adjust effect parameters loaded in a slot, change to a different effect in a module loaded in a slot (in this menu you can't change module).

Select a slot loaded with a module, and parameter list will show as below:



Use quick access knob 1 or press on/off switch to turn the selected slot on/off.

Turn quick access knob 2 to switch current effect in this module.

Press EDIT button to expand available parameters of current effect:



Press EDIT button again to collapse:

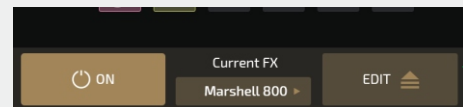

You can press current effect name to enter module/effect menu in anytime:

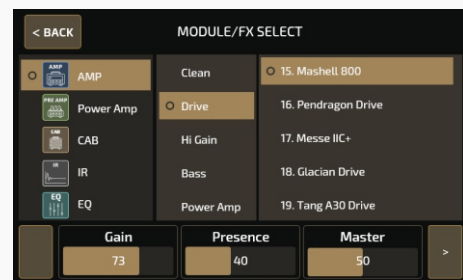

Move, Swap, Copy, Paste and Delete Modules

Move

Drag and drop a module on an empty slot (or between slots):

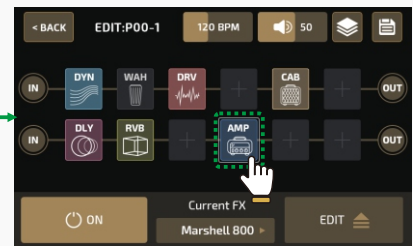
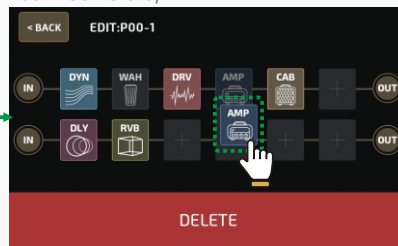
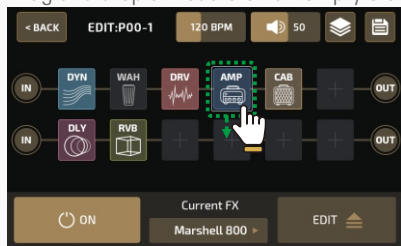

Or you can press and hold a module until module edit menu appear:

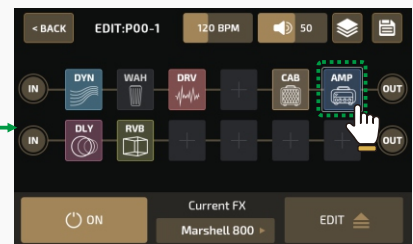
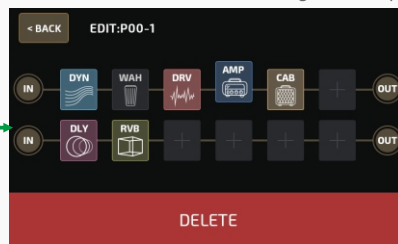
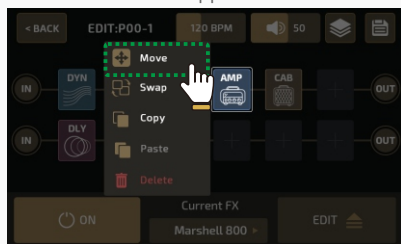

Select Move and choose a target slot by touchscreen or Main Knob:

You can delete selected module by moving it to the red delete area as it appears on the bottom of the screen

Customizing Your Ampero II Stomp

Swap

Drag and drop a module on the target module:

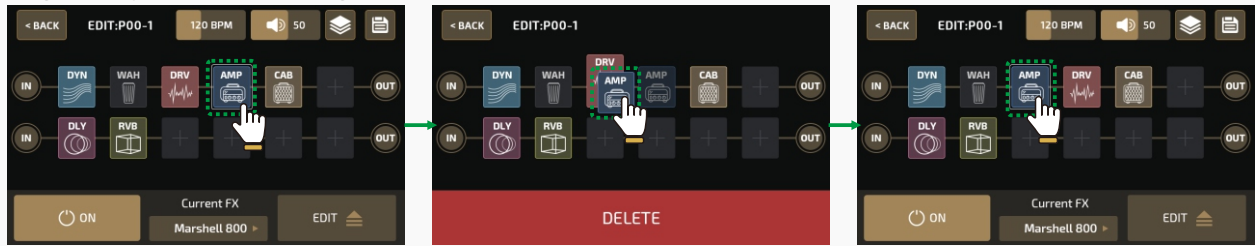

Or you can press and hold a module until module edit menu appear:

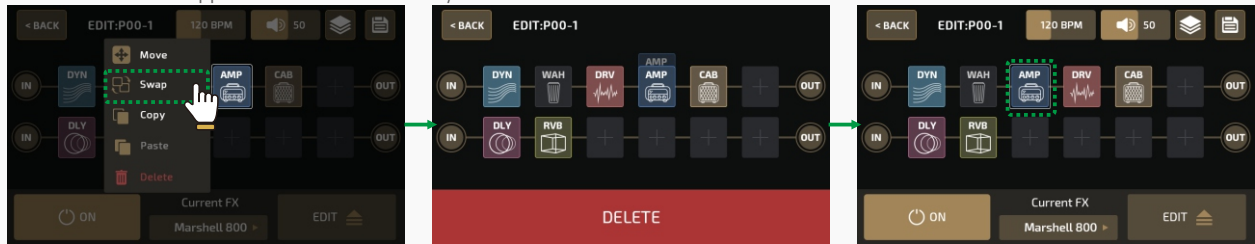

Select Swap and choose a target module by touchscreen or Main Knob:

Copy/Paste

You can copy a module (incl. current effect and parameter settings) and paste it repeatedly.

To copy, press and hold a module until module edit menu appear, then select Copy:

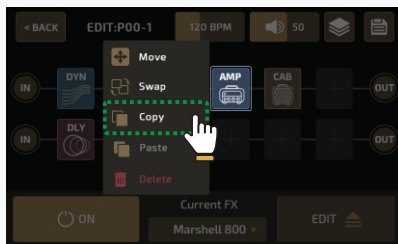

To paste, press and hold target slot until module edit menu appear, then select Paste:

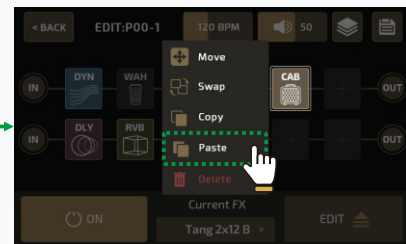

Please note:

- (1) You need to copy before paste.
- (2) The copied module can be used in different patches.
- (3) The copied module data will be lost if the unit power is off.
- (4) If there already exists a module in target slot, pasting will overwrite existing data. A message will come up to indicate:

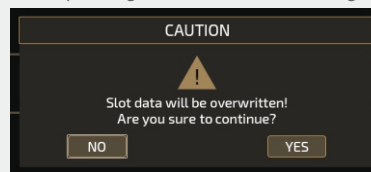

- (5) If you copied one other module with an existing copy, the previous data will be overwritten.

Delete

Press and hold a module until module edit menu appear, then choose Delete:

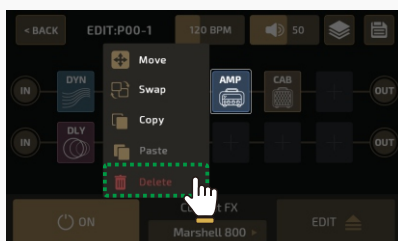

When moving/swapping modules, the red delete area also appears. So you can also drop the module to the area to delete the selected module.

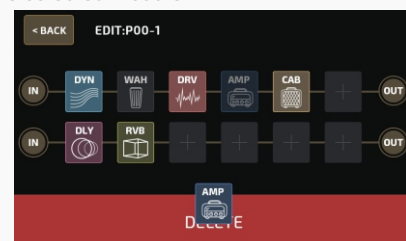

In any time, you can press Back button to cancel operation.

Customizing Your Ampero II Stomp

When editing modules/effects chains, in some extreme cases the signal processor may become overloaded and display this caution:



If this happens (the effect output is probably abnormal), try changing out some of the effects modules/node positions/chain types, move modules back or to another position, delete unnecessary modules, etc.

Patch Tempo And Patch Volume

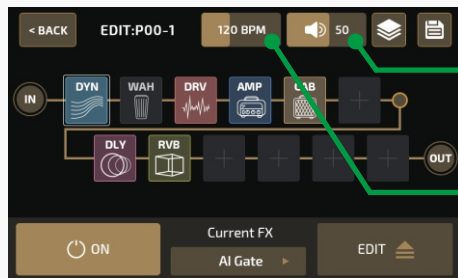

In effects chain menu, slide on the patch volume bar (or use Main Knob) to adjust patch volume from 0 to 100:

Slide on the patch tempo bar to adjust patch tempo from 40BPM to 300BPM:

Patch tempo and volume will change depending on patch settings.

Tap Tempo And Tap Divide

If you want a certain effect to be controlled by tap tempo, go into the patch settings, select an effect, then select S8YNC. When you do this, the time will sync to the tap tempo value.



You can also opt to use tap divide rather than time-based tempo. The default tap divide is set to quarter notes (1/4). Set the tempo by repeatedly tapping the footswitch. This tempo will apply to the delay time and other effects with adjustable speed parameters.

Tap divide values in relation to their musical beats are shown below:

Time Value	Beats	Display
Whole note	4	1/1
Half note	2	1/2
Dotted half note	3	1/2D
Half note triplet	4/3	1/2T
Quarter note (no divide)	1/1	1/4
Dotted quarter note	3/2	1/4D
Quarter note triplet	2/3	1/4T
Eighth note	1/2	1/8
Dotted eighth note	3/4	1/8D
Eighth note triplet	1/3	1/8T
Sixteenth note	1/4	1/16

To use tap tempo function you can:

- (1) Switch to Stomp Mode, assign Tap Tempo function to one of footswitch 1-3; when in Tap Tempo, the footswitch LED will turn blue and will flash with the tempo set
- (2) Apply a momentary footswitch and assign Tap Tempo function
- (3) Use MIDI controller (see MIDI Controller Information List on [page 34](#))

To setup built-in footswitches please go to CTRL section ([page 24](#));

To setup external footswitches, please go to GLOBAL section ([page 30](#)).

Effects with Tap Tempo support are mostly modulation (MOD module), delay (DLY module) and auto filter (FREQ module) effects. See Effects List ([page 41](#)) for details.

Customizing Your Ampero II Stomp

Using FX Loop

To use unit's FX loop jacks you need to:

- (1) Assign input source/output destination to FX loop jacks (see Input Node Settings section on [page 13](#), Output Node Settings section on [page 14](#) and USB Audio section on [page 31](#))
- (2) Add a FX loop related module (FX SND/RTN/LOOP)

Next we'll show you how to setup an FX loop related module.

FX SND (FX Loop Send)

The FX SND module will send the received signal from previous slot/node to FX Loop Send jack:

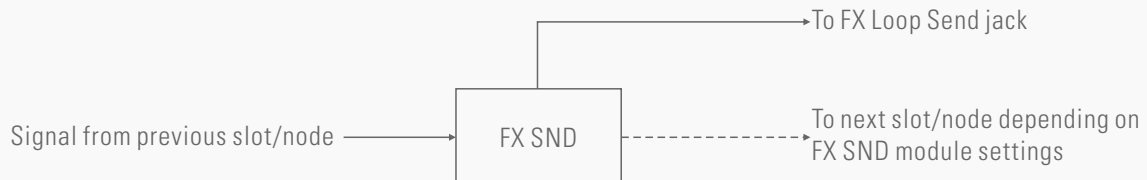

Available parameters are shown below:

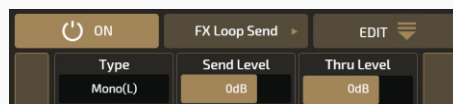

Use **Type** to select input signal processing type:

- Mono (L): Mono I/O configuration, receives left channel of input signal only
- Mono (R): Mono I/O configuration, receives right channel of input signal only
- Stereo: Stereo I/O configuration

Use **Send Level** to adjust output level to FX Loop Send jack from Mute~-60dB~+20dB, default is set to 0dB.

Use **Thru Level** to adjust output level to next slot/node from Mute~-60dB~+20dB, default is set to 0dB.

FX RTN (FX Loop Return)

The FX RTN module will send the received signal from FX Loop Return to next slot/node:

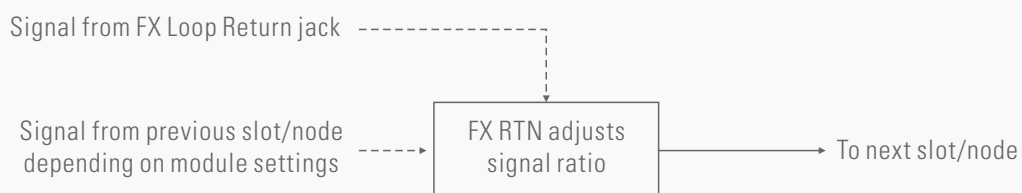

Available parameters are shown below:



Use **Type** to select input signal processing type:

- Mono (L): Mono I/O configuration, receives left channel of input signal only
- Mono (R): Mono I/O configuration, receives right channel of input signal only
- Stereo: Stereo I/O configuration

Use **Return Level** to adjust input level from FX Loop Return jack from Mute~-60dB~+20dB, default is set to 0dB.

Use **Mix** to adjust signal ratio between signal from previous slot/node and signal FX Loop Return jack. The range is 0~100, default is set to 50.

When **set Mix to 0**, only signal from previous slot/node will be sent.

When **set Mix to 100**, only signal from FX Loop Return jack will be sent (this also means all slots/nodes before FX RTN jack will be disabled).

Customizing Your Ampero II Stomp

FX LOOP

The FX LOOP module sends signal from previous slot/node to FX Loop Send jack and signal from the FX Loop Return jack to next slot/node. When using with external devices, this module will "insert" the external device connected to FX Loop jacks to an effects chain:

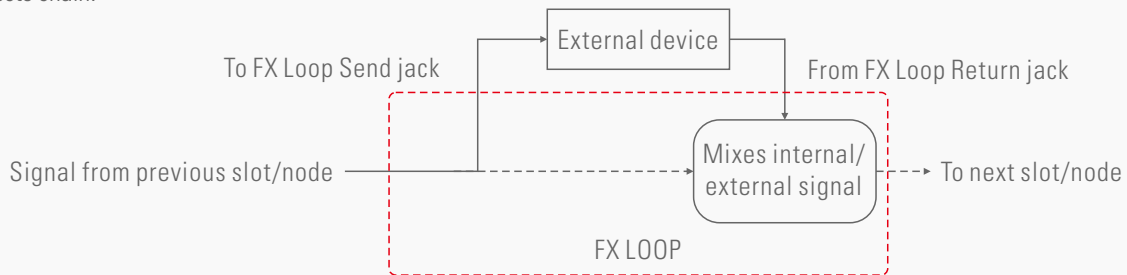

Available parameters are shown below:

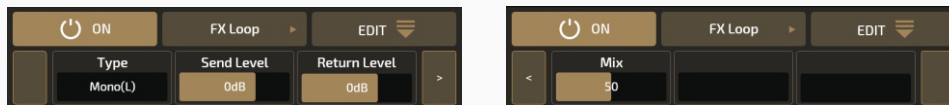

Use **Type** to select input signal processing type:

- Mono (L): Mono I/O configuration, receives left channel of input signal only
- Mono (R): Mono I/O configuration, receives right channel of input signal only
- Stereo: Stereo I/O configuration

Use **Send Level** to adjust output level to FX Loop Send jack from Mute~-60dB~+20dB, default is set to 0dB.

Use **Return Level** to adjust input level from FX Loop Return jack from Mute~-60dB~+20dB, default is set to 0dB.

Use **Mix** to adjust signal ratio between signal from previous slot/node and signal FX Loop Return jack. The range is 0~100, default is set to 50.

When **set Mix to 0**, only signal from previous slot/node will be sent.

When **set Mix to 100**, only signal from FX Loop Return jack will be sent.

Serial And Parallel FX Loop

- A Serial FX Loop means external device is connected to other effects chain in series:

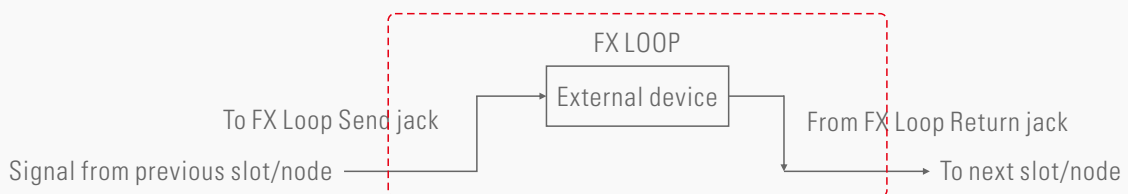

- A Parallel FX Loop means external device is connected to other effects chain in parallel:

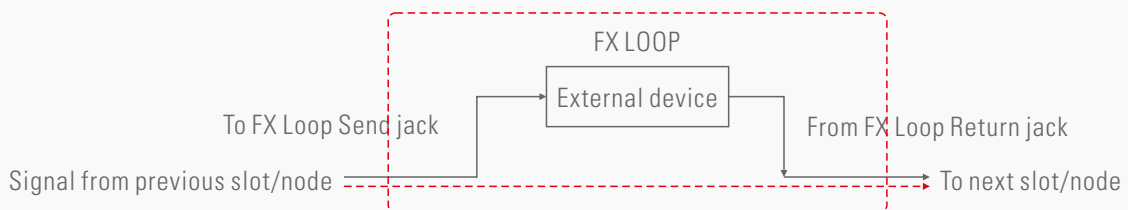

Ampero II Stomp supports both serial and parallel FX loop connection. Fine tune the parameters depending on your needs:

- Use as a serial FX loop
FX SND: Set **Thru Level** to 0
FX RTN and FX LOOP: Set **Mix** to 100, and **Send Level** cannot be muted
- Use as a parallel FX loop

Set the parameter values differ from mentioned above; we recommend to keep default settings

Reminder: When using FX SND/RTN/LOOP modules, please be careful to prevent from abnormal operations (putting FX RTN module before FX SND module, use more than two FX LOOP modules in an effects chain, using FX SND/RTN/LOOP modules while setting input/output node source to FX Loop jacks, etc.) which may cause abnormal noise, even unit malfunction.

Customizing Your Ampero II Stomp

CTRL/EXP

Use the control settings to determine footswitch functions in Stomp Mode and quick access knob targets, setup the expression pedal parameters, and calibrate the expression pedal.

Remember that all the control settings will change as you change patches. If you switch patches or turn the unit off before saving your changes, the changes will be lost. Make sure to press SAVE on the upper right of the display screen to save your settings.

Press CTRL on the main menu to enter the control menu.

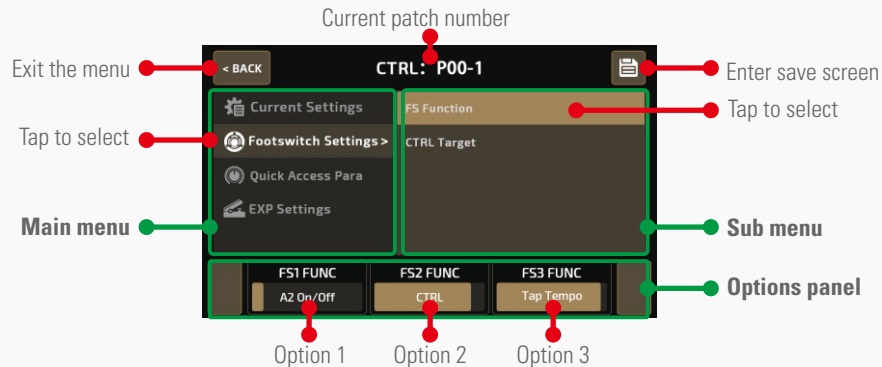

Make selections from the right and left panels.

Like the effects module parameter menu, the selection panel features three adjustable options. These options will change according to the current menu option.

If the selected menu has more than three adjustable options, there will be an arrow at the right of the selection panel. Press the arrow to see the other options.

Use the three quick adjust knobs to adjust the options directly above the knobs. If there are no options corresponding to a certain knob, turning that knob will have no effect.

Current Settings

Pressing Current Settings allows you to see the footswitch function in Stomp Mode, CTRL footswitch control target, quick access para targets, and the expression pedal target of current patch.

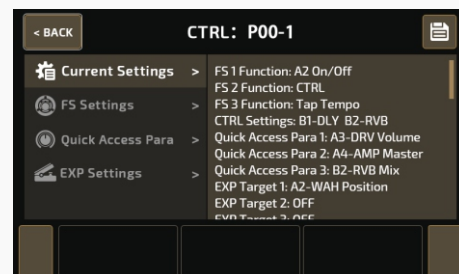

FS Settings

This menu allows you to set the footswitch functions in Stomp Mode under the current patch.

Function

Under the Function option you can assign a function to footswitch 1-3:

- A1-B6 On/Off: For switching slot A1-B6 on/off. Footswitch LED color depends on the module you assigned to the corresponding slot.
- CTRL: For using CTRL function, you can use it to switch multiple slots on/off.
- Tap Tempo: For Tap Tempo function: the footswitch LED will turn blue and will flash with the tempo set. Set the tempo by repeatedly tapping the footswitch. This tempo will apply to the delay time and other effects with adjustable speed parameters.
- EXP On/Off: For switching external expression pedal on/off.

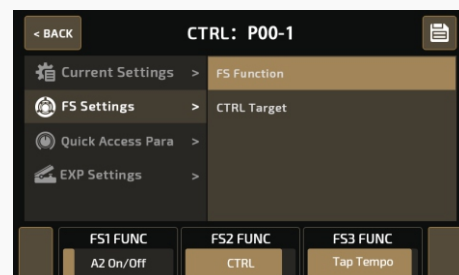

Customizing Your Ampero II Stomp

Function, module and footswitch color are listed below:

Function/Module	Color
DRV, DYN	Red (LED on=slot on, LED off=slot off, same below)
WAH, VOL	Cyan
AMP, PRE AMP	Blue
EQ, FREQ	White
CAB, IR	Yellow
MOD, FX LOOP, FX SND, FX RTN	Green
DLY, RVB	Purple
CTRL	Red/Green
Tap Tempo	Flashing Blue
EXP On/Off	Red (Off)/Green (On)

CTRL Target

Use the CTRL Target menu to select which slots of the current patch will be controlled by the CTRL footswitch.

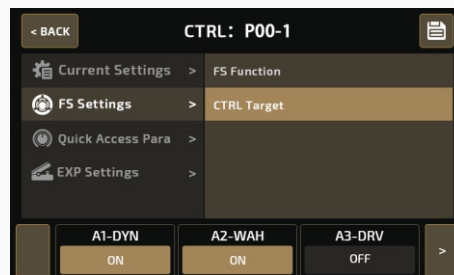

The 12 effects slots are listed in the panel, with yes and no below each module to show if the CTRL footswitch is activated or not:

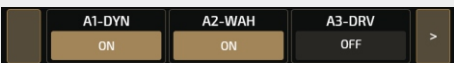

Slot A1 and A2 are loaded with DYN and WAH modules and controlled by CTRL footswitch
Slot A3 is loaded with DRV module and not controlled by CTRL footswitch

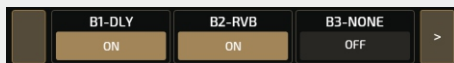

B2 – NONE indicate slot B2 is empty slot

Use the quick access knobs to change between yes/no, and press the arrows on the right/left to scroll through the modules.

Quick Access Para

This menu allows you to set the three quick access of current patch available in main menu. The targets can be all effects parameters used in the current patch, patch volume and patch tempo.

Use **SLOT/FUNC** to select a target slot/function. The available selections depend on the modules/effects used in the current patch. If there is no module/effect, the available selections are OFF, Patch Tempo, Patch Volume only.

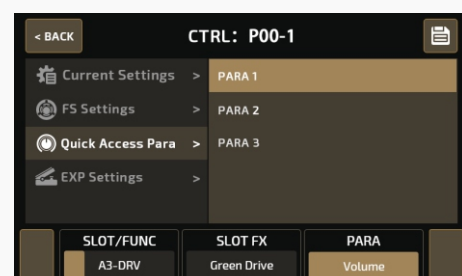

If you don't want the quick access knob on, select OFF to turn its function off. When a quick access knob is off, the parameter panel will display the status as shown:

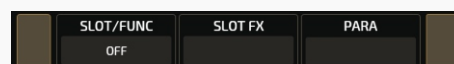

If you select a slot, **SLOT FX** will show the current effect you're using in the center of the panel.

Use **PARA** to select the parameter you want to control. The controllable parameters will vary with different effects. Please refer to **Effects List** (on [page 41](#)) for more info.

Customizing Your Ampero II Stomp

You can press any quick access para in main menu to assign/set a quick access para as shown below:

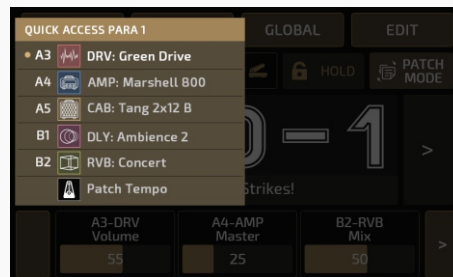

EXP Settings

You can connect your own expression pedal to control various effects parameters.

To use an expression pedal to control parameters, please set EXP/CTRL jack function to EXP (see **Controls** section on [page 24](#)), assign parameters and turn the EXP switch on. If the current patch does not have any effect controllable by expression pedal or the expression pedal switch is off, the pedal will not function.

From this menu, you can control the settings of or calibrate your external expression pedal.

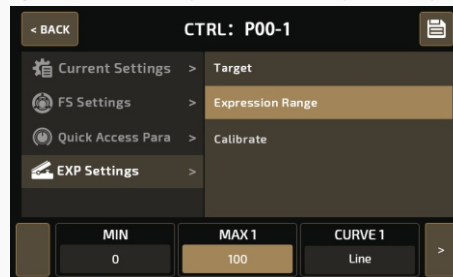

There are three options within this menu: Target, Expression Range, and Calibrate.

Target

Under the Target option, you can set the pedal's control target. You can set up a maximum of four effects parameters for the built-in expression pedal to control.

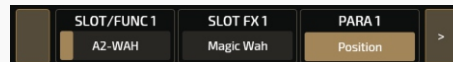

Use **SLOT/FUNC X** (X standing for 1-4 controllable targets) to select a target slot/function. The available selections depend on the modules/effects used in the current patch. If there is no module/effect, the available selections are OFF, Patch Tempo, Patch Volume only.

If you select a slot, **SLOT FX X** will show the current effect you're using in the center of the panel.

Use **PARA X** to select the parameter you want to assign to the expression pedal. The selectable parameters will vary with different effects. Please refer to **Effects List** (on [page 41](#)) for more info.

Touch the right or left arrows to flip through the panel.

You can also turn the expression pedal off by turning selecting OFF in the settings panel.

Expression Range

Under the Expression Range option, you can set the expression pedal expression range and sweep curve. There are four adjustable targets to change these settings.

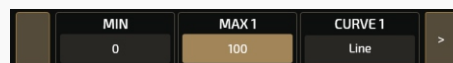

MIN X (X standing for 1-4 controllable targets) represents the lowest range value. This is the value the pedal will have when pushed all the way up.

MAX X represents the highest range value, when the pedal is pushed all the way down.

CURVE X represents the curve line the pedal will follow when pushed from all the way up to all the way down.

The MIN and MAX range is the same as corresponding effect parameter, and the MIN value can be greater than the MAX value.

There are three CURVE types:

- Line follows a straight line
- Exp follows an exponential line from slow to fast
- Log follows a logarithmic line that changes as the pedal moves

Customizing Your Ampero II Stomp

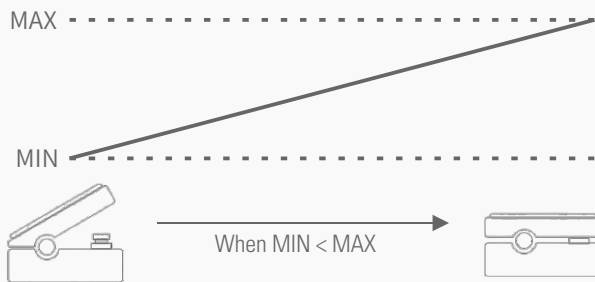

Touch the right or left arrows to flip through the panel.

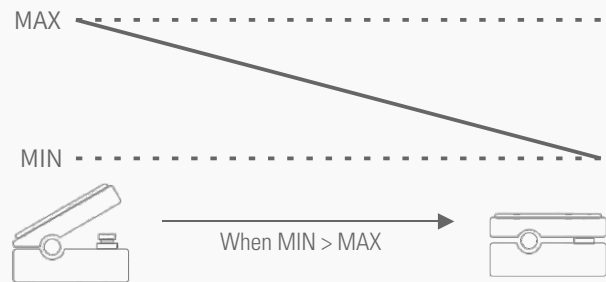

Calibrate

The Calibrate option helps you calibrate your expression pedal. It is important to calibrate the expression pedal if you find the sweep has very little or too much change in the effect you've set.

Press Calibrate on the selection panel, and these instructions will appear:

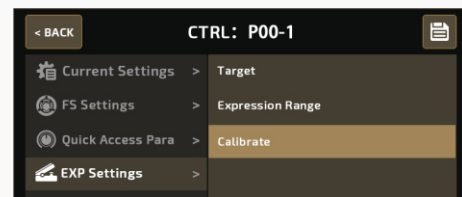

1. Bring the pedal all the way up (back) and press NEXT.

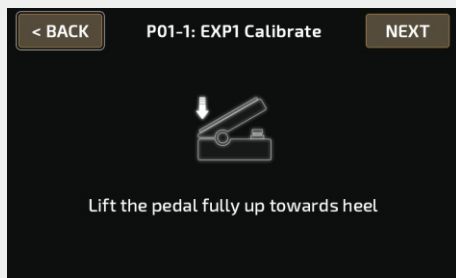

2. Then press the pedal all the way down and press NEXT. The calibration will be set, and this message will appear:

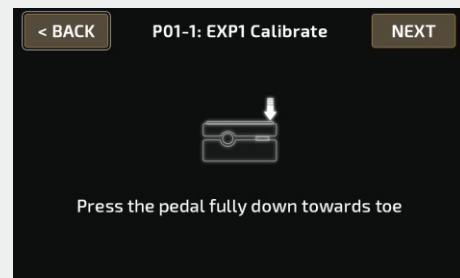

3. Then, strongly press the pedal toe down and press NEXT.



4. The calibration will be set, and this message will appear:

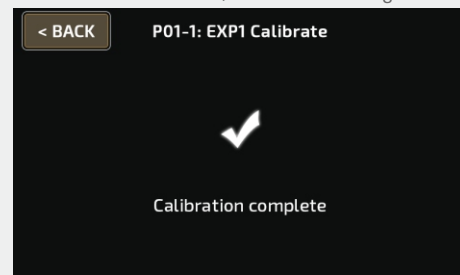

5. If the calibration fails, this message will appear. Press REPEAT to begin the calibration process again. Or press BACK to exit the calibration process and return to the previous menu.

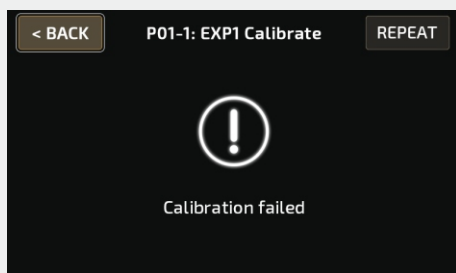



Many of the factory patches have been set up to use with expression pedal. These can be used without any further setup.

Customizing Your Ampero II Stomp

Expression Pedal Switching and Display

You can switch external pedal on/off status by:

- Assign EXP On/Off to any footswitch, then switch to Stomp Mode
- Use an external MIDI controller
- Press  button in main menu

When expression pedal is switched on, the expression pedal indicator () is on, and a message will come up:

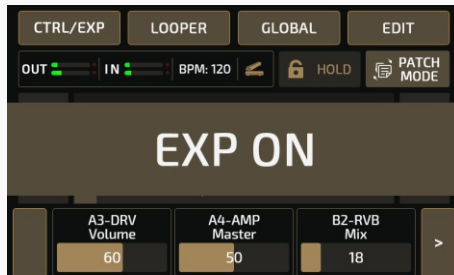

When expression pedal is switched off, the expression pedal indicator () is off, and a message will come up:



SAVE

You can save the changes you made to your effects parameters, control information, and other editable targets.

It is very important to save the changes you made to your tone and control settings!

In effects chain menu, press  button and the save menu will appear:

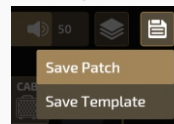

Then select Save Patch to save your tone:



Patch Management

In default settings, press patch number in main menu to enter patch list.

The patch list menu shows all patches on your Ampero II Stomp. You can browse through and jump to a patch directly, edit the patch list order, or copy/paste any patch.

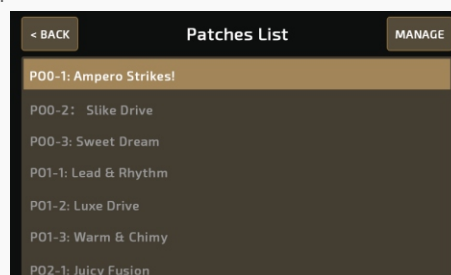

To select a patch, click on a patch name in the patch list.

Customizing Your Ampero II Stomp

Manage Patch Order

Select a patch, press Manage button and the management menu will appear:

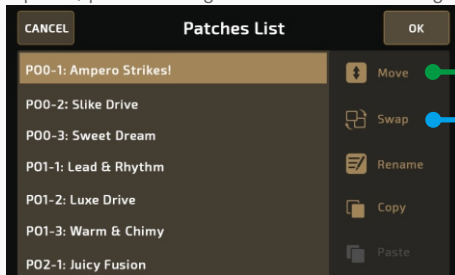

You can sort the list by moving or swapping.

• Move

Press Move in the management menu, select a position, then the patch will be "inserted":

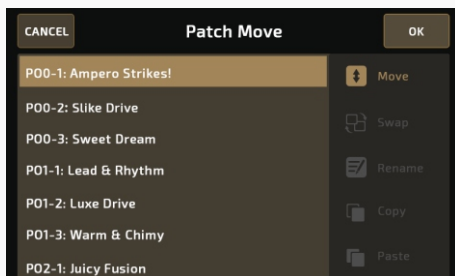

• Swap

Press Swap in the management menu, and select a new position you need, then the two patches will be swapped:

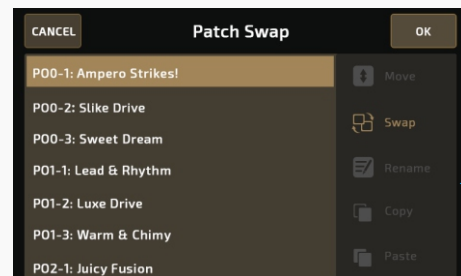

Rename

Select a patch, press Manage button, then press Rename in the management menu:



Enter a name and click OK to finish.

Copy And Paste

Select a patch, press Manage button, then press Copy in the management menu to copy a patch:

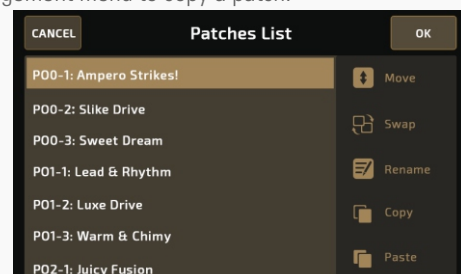

Then find a position you need and press Paste to paste the patch you copied.

Please note:

- (1) You need to copy before paste.
- (2) The copied patch data will be lost when you move/swap patches, exit patch list or the unit power is off.
- (3) If there already exists a patch in the target position, pasting will overwrite existing data. A message will come up to notice:

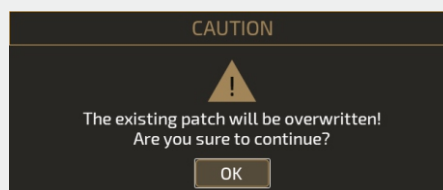

- (4) If you copied one other patch with an existing copy, the previous data will be overwritten.

Customizing Your Ampero II Stomp

GLOBAL

Use the GLOBAL menu to set Ampero II Stomp's global functions like I/O, USB Audio, Global EQ and MIDI settings. You can also return to factory settings from this menu.

Global settings will affect unit's overall working status. These will override any other settings made to your patches. Any changes made in Global setting will be automatically saved and immediately operational.

In the main menu, press GLOBAL to enter the global settings menu. The screen will look like this:

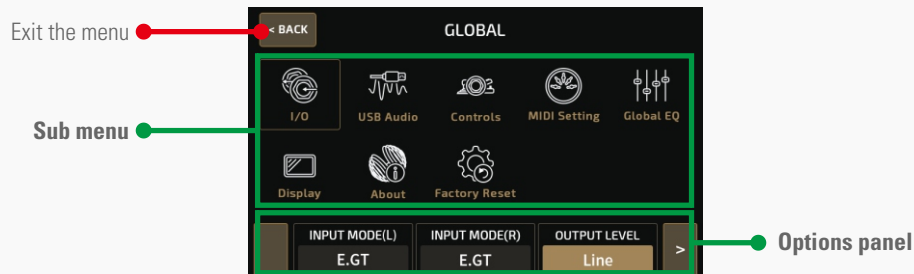

You can either use the touchscreen or turn the main knob to scroll through the menu targets. As you select your menu target, buttons will appear in the selection panel.

The selection panel will display the adjustable options of the target you select. These will vary according to the selection. If there are more than three options in the current selection, use the arrows to the right and left to scroll through the options.

Use quick access knobs 1-3 to adjust the options in the selection panel. If there is no option in the panel above a certain quick access knob, moving that knob will have no effect.

I/O

Set the global input/output levels and modes in the I/O menu.

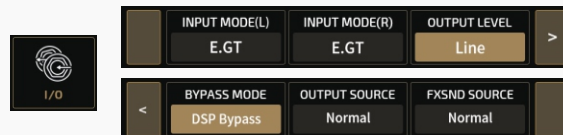

Use **INPUT MODE (L)/(R)** to select between input modes for individual input jack:

- E.GT: Electric guitar or bass
- GT: Acoustic guitar or other acoustic instrument
- Line: Keyboard or synthesizer

Defaults are both set to E.GT.

Use **OUTPUT LEVEL** to select between instrument output level (Inst) and line output level (Line) for OUTPUT jacks, default is set to Line. Use the instrument level for connecting to amplifiers or other effects equipment. Use the line level for connecting to mixers or audio interfaces.

Use **BYPASS MODE** to select between DSP Bypass and Analog Bypass modes.

Please remember USB audio will also be bypassed when the unit is bypassed.

- DSP Bypass

Default bypass mode featuring digital buffer bypass switching, great for avoiding signal loss that caused by long signal path (long patch cables, too many pedals in the chain, etc.). In most situation, DSP Bypass is recommended.

Supports mono in/mono out, mono in/stereo out, stereo in/out configurations. The output jacks and phones jack share the same output.

- Analog Bypass

Hardwire true analog bypass mode that keeps your signal path pristine. In this mode, the left input is directly connected to left output, so as the right I/Os. If you're facing impedance matching issues (e.g. use Ampero II Stomp before fuzz pedals), or want to keep a pure analog signal path, this mode is recommended.

Supports only mono in/mono out and stereo in/out configurations. The phones output and effect tail function will be disabled.

Customizing Your Ampero II Stomp

Use OUTPUT SOURCE and FX SND SOURCE to select from different output signal source for output and FX loop send jacks:

- Normal: Both effect and USB audio output will be sent to the corresponding jack.
- USB Only: Only USB audio output will be sent to the corresponding jack. When Ampero II Stomp is your main USB audio interface, if you need to monitor a track in a DAW while recording (or software monitoring), this selection is recommended. If not, you'll hear both unit effect output and a slightly delayed DAW monitor output.
- Dry: Both dry signal and USB audio output will be sent to the corresponding jack.

Please note:

- (1) When using FX Loop Send jack as a output jack, the output signal may vary from patch settings, such FX SND/FX LOOP module parameter settings and position on effects chains, output node settings, etc.
- (2) OUTPUT SOURCE option also affects phones output.

USB Audio

Use this menu to set up USB audio settings when using Ampero II Stomp as a USB audio interface. Ampero II Stomp features a 8-in, 8-out USB audio interface with signal routings shown as below:



USB Audio Inputs Routing

Same rule as above: even number stands for left channel and odd number stands for right channel.

- Chain A outputs (after slot A6) are sent to USB Audio Input 1/2
- Chain B outputs (after slot B6) are sent to USB Audio Input 3/4; USB Audio Input 3/4 remains as long as the chain B is activated (not shown grey; regardless of chain B output node settings)
- When chain A and B are in series, USB Audio Input 1/2 and 3/4 are the same
- FX Loop Return inputs are directly sent to USB Audio Input 5/6 regardless of patch settings
- Input L/R signals (dry signal) are directly sent to USB Audio Input 7/8 regardless of patch settings

USB Audio Outputs Routing

- USB Audio Output 1/2 (the main output) are sent to output L/R and phones jacks
- USB Audio Output 3/4 to 7/8 are reserved for sending different USB outputs depending on your settings of your computer or DAWs

When recording, adjust the optimal **REC LEVEL** for each USB Audio Input 1/2 to 7/8 according to the instrument or other input you're using. Adjustable ranges are all from Mute~-60dB~+20dB, defaults are all set to 0dB.

Use **MONITOR LEVEL** to set a proper monitor level for overall USB audio outputs. Adjustable range is from Mute~-60dB~+6dB, defaults is set to 0dB.

Use **OUTPUT SOURCE** and **FX SND SOURCE** to determine which USB audio output will be sent to the corresponding jack. In default, the OUTPUT SOURCE is set to USB OUT 1/2, and FX SND SOURCE is set to USB OUT OFF.

Customizing Your Ampero II Stomp

Detailed Hardware And USB Audio Routing

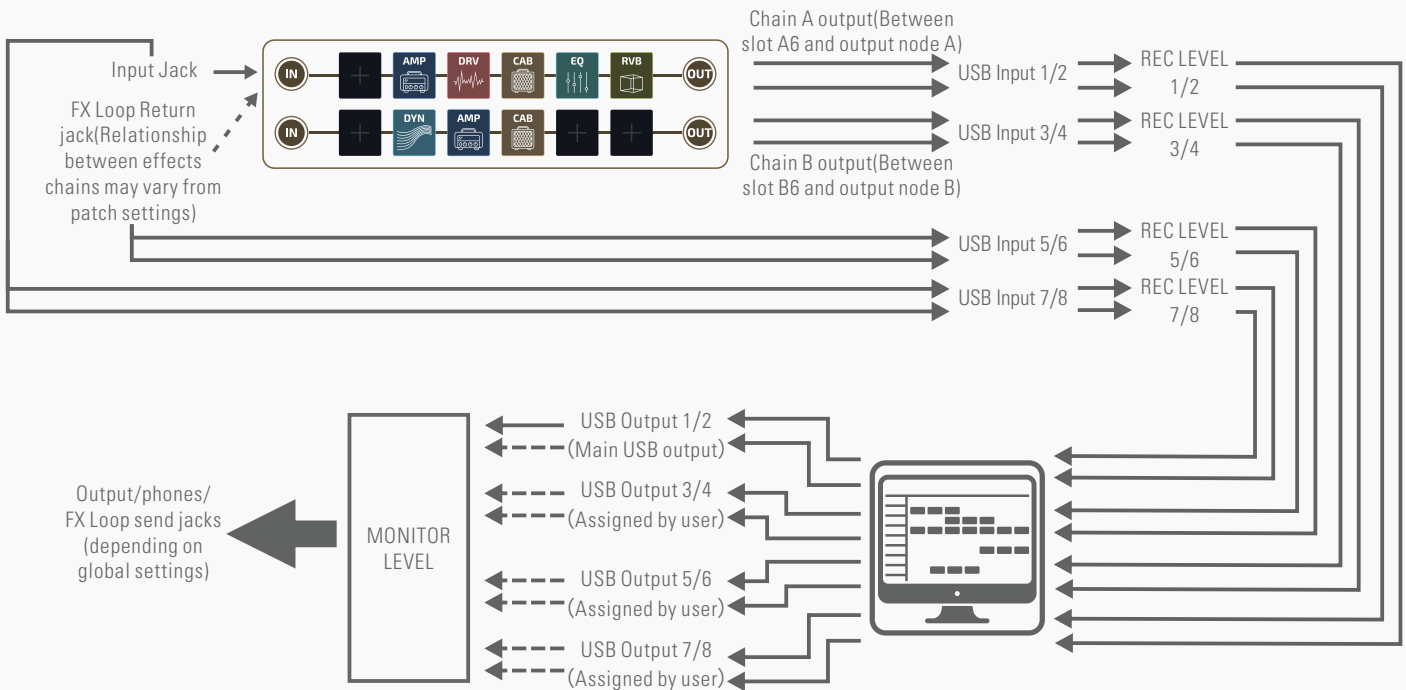

Advanced USB Audio Interface Function Guide

Next we'll show you some advanced tricks when using your Ampero II Stomp as a USB audio interface.

Example 1: Monitoring Different Outputs

You can use Ampero II Stomp's output/phones jacks and FX loop send jack for monitoring different signal sources. In this example, a guitar is connected to unit's left input, and a bass is connected to the right input. The two instruments will be recorded simultaneously with different effects:

- (1) Connect a pair of headphones to phones jack, connect a pair of monitor amps to FX loop send jack via a Y cable (unbalanced connection);
- (2) Launch a DAW and create two mono audio tracks. Set track 1's input to USB Audio Input 1, output to USB Audio Output 1/2; set track 2's input to USB Audio Input 3, output to USB Audio Output 3/4. Then turn on monitor switches on both tracks;
- (3) On your Ampero II Stomp, enter USB Audio menu and set OUTPUT SOURCE to USB OUT 1/2, then set FX SND SOURCE to USB OUT 3/4;
- (4) Enter I/O menu, set both OUTPUT SOURCE and FX SND SOURCE to USB Only;
- (5) In the current patch, set the chain A/B to parallel and use mono effects only (e.g. amps and cabs);
- (6) Set chain A's input source to Input L and output to output jacks;
- (7) Set chain B's input source to Input R and output to FX loop send jack;
- (8) You'll hear guitar signal in headphones and bass signal in monitor amps if everything is set. Then record and get individual guitar and bass tracks.

Example 2: Record Dry/Wet Tracks Simultaneously or Record Dry, Monitor Wet

You can use Ampero II Stomp's multiple USB audio I/Os for recording multiple dry/wet tracks with DAW.

In this example, all global settings are set to default, factory patch P01-1 Ampero Strikes! is loaded:

- (1) Connect a pair of headphones to phones jack and connect a guitar to unit's input L channel;
- (2) Launch a DAW and create two audio tracks. Set track 1's input to USB Audio Input 1/2, output to USB Audio Output 1/2; set track 2's input to USB Audio Input 7, output to USB Audio Output 1/2. Then keep monitor switches off on both tracks;
- (3) Still in DAW, set the two tracks can be recorded at the same time;
- (4) Record both tracks. Then you get a stereo guitar track with effects and a mono dry guitar track.

If no wet signal is needed, in step (2) you only need to create one audio track and set track input to USB Audio Input 7 (or 7/8 depending on your needs).

Customizing Your Ampero II Stomp

Example 3: Reamping or Tone Creation With Dry Tracks

You can route Ampero II Stomp's USB audio outputs to effects chains for reamping.

In this example, all global settings are set to default, and several guitar/bass dry DI tracks are needed:

- (1) On your Ampero II Stomp, create a new patch and use chain A only. Set input node Source to USB OUT 3/4, INPUT CH to L, and keep other parameters as default;
- (2) Add a AMP and a CAB module in AMP-CAB order;
- (3) Launch a DAW and create two audio tracks. Set track 1's input to None, output to USB Audio Output 3/4; set track 2's input to USB Audio Input 1, output to USB Audio Output 1/2. Then keep monitor switches off on both tracks;
- (4) Still in DAW, set only track 2 can be recorded, and import a dry track (Audio Clip A) to track 1;
- (5) Connect a pair of headphones to phones jack or a pair of monitor amps to output L/R jacks (balanced connection);
- (6) In DAW, start playback and loop the dry track in track 1, you'll hear the Audio Clip A with effects (depending on AMP and CAB settings);
- (7) Adjust AMP and CAB parameters;
- (8) Turn off looping switch in DAW. Record on track 2 with track 1 playing simultaneously. Then you get a wet track as you've heard in step (6) (7);
- (9) Repeat the steps above to get different reamped tracks.

For tone creation, you only need to execute steps (1) to (7).

Controls

Use this Controls menu to set up unit mode, bank select mode, automatic cab match and external controllers.

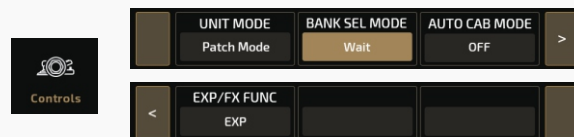

Use **UNIT MODE** to switch between Patch Mode and Stomp Mode. This works same as holding footswitch 3 or mode selector in main menu.

Use **BANK SEL MODE** to switch between two bank select modes in Patch Mode: Initial and Wait. This affects both built-in and external footswitches:

- Initial: Ampero II Stomp will jump to a new patch immediately after switching a bank.
- Wait: When switching banks, the patch you're using won't be changed (footswitch LEDs on Ampero II Stomp will keep flashing) until you tap a footswitch again to confirm your selection.

The **AUTO CAB MATCH** function will automatically help you match a cab when switching amps. Default is set to off:

- Great for patches with only one AMP and CAB module
- The cab will automatically change according to the amp model you choose; matched cab list please check Effects List on page XX

EXP/CTRL FUNC allows you to set up the working mode of EXP/CTRL jack and the functions of external footswitches. Available selections are EXP (expression pedal), Single FS (single footswitch controller) and Dual FS (dual footswitch controller), default is set to EXP.

- Switching to EXP: No more options available

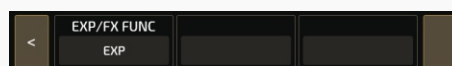

- Switching to Single FS: An extra **FS4 TAP** option appears for selecting external footswitch function:

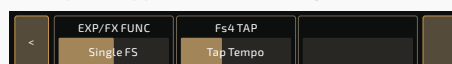

- Switching to Dual FS: Extra **FS4 TAP** and **FS5 TAP** options appear for selecting external footswitch function:

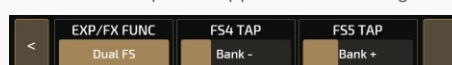

Customizing Your Ampero II Stomp

FS4 TAP and **FS5 TAP** can be set up as follows:

- Loop Rec/Play: Record/play loop phrases
- Loop Stop: Stops looper playback
- Loop Undo/Redo: Executes undo/redo function
- Loop 1/2 SPD: Switches 1/2 speed record/playback on/off
- Looper Rev: Switches reverse record/playback on/off
- Looper: Enter looper menu
- Looper Exit: Exit looper menu
- Tuner: Enter/exit tuner
- Bank+/Bank-: Change banks by toggling up or down
- Tap Tempo: Tap tempo function
- Patch+/Patch-: Change patches by toggling up or down
- CTRL: CTRL function depending on patch settings
- EXP On/Off: Switching external expression pedal on/off
- Unit Mode: Switches between Patch mode and Stomp mode
- A1-B6 On/Off: Switching corresponding slot on/off

Plus:

When set EXP/CTRL FUNC to Single FS, the FS4 TAP defaults to Tap Tempo;

When set EXP/CTRL FUNC to Dual FS, the FS4 TAP defaults to Bank- and FS5 TAP defaults to Bank+.

MIDI Settings

This menu allows you to set up Ampero II Stomp's MIDI input source, MIDI I/O channels, MIDI clock I/O options.



MIDI IN SOURCE lets you decide MIDI input source:

- DIN Only: Receives MIDI messages from MIDI IN jack only
- USB Only: Receives MIDI messages from USB jack only
- Mixed: Receives MIDI messages from both MIDI IN and USB jacks

Default is set to Mixed.

INPUT CH (DIN/USB) and **OUTPUT CH (DIN/USB)** options are for setting MIDI input/output channels of USB/MIDI jacks. The ranges are all Omni-1-16, defaults are all Omni.

CLOCK SOURCE lets you choose MIDI clock source for syncing with other devices:

- Internal: Use internal clock only
- DIN Only: Uses only external clock, receives MIDI clock messages from MIDI IN jack
- USB Only: Uses only external clock, receives MIDI clock messages from USB jack
- Mixed: Uses both internal/external clock sources (receives MIDI clock messages from both MIDI IN and USB jacks); later clock messages will replace previous messages

Default is set to **Mixed**. If you set clock source to DIN Only or USB only, Ampero II Stomp's Tap Tempo will not function.

CLOCK OUT (DIN/USB) switches MIDI clock output on/off. Turn on to use Ampero II Stomp as your main MIDI clock. If you're using clock out, the external clock input will be ignored; if you set **CLOCK SOURCE** to **DIN/USB Only**, there will be no MIDI clock output. Defaults are all set to Off.

Customizing Your Ampero II Stomp

Global EQ

This menu allows you to setup Ampero II Stomp's global EQ for overall tone sculpting:

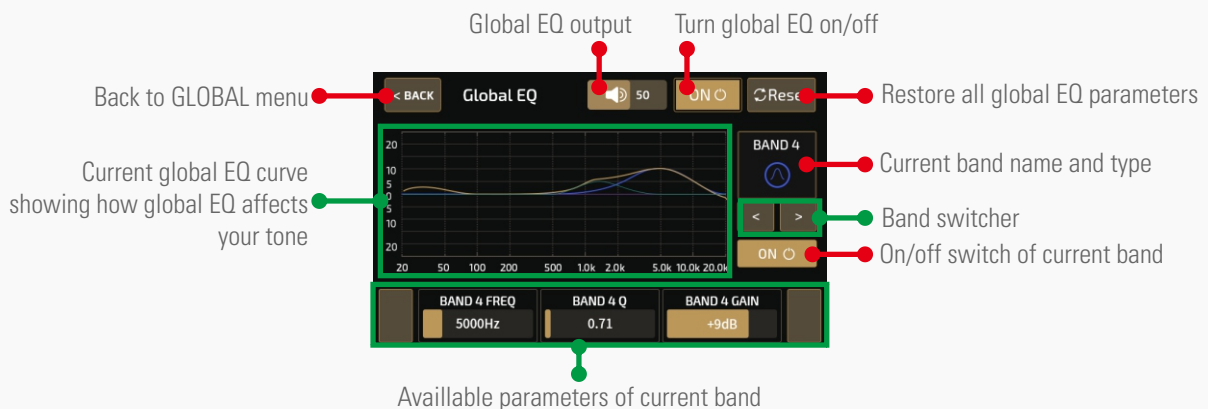

This is a 4-band parametric EQ with low/high cut and low/high shelf filters with individual band on/off switches:

- LOW CUT: High pass filter that attenuates low frequency contents under the frequency you set; available parameters are FREQ and Q
- LOW SHELF: Low shelf filter that boosts/cuts low frequency contents under the frequency you set; available parameters are FREQ, Q and GAIN
- BAND 1-4: Peak filters that boosts/cuts a certain frequency range; available parameters are FREQ, Q and GAIN
- HIGH SHELF: High shelf filter that boosts/cuts high frequency contents above the frequency you set; available parameters are FREQ, Q and GAIN
- HIGH CUT: Low pass filter that attenuates high frequency contents above the frequency you set; available parameters are FREQ and Q

Detailed parameter descriptions:

- FREQ: Controls the filter center frequency/cutoff frequency ranging from 20Hz to 20000Hz. The default frequency of each bands are:
 LOW CUT and LOW SHELF: 20Hz
 BAND 1: 100Hz
 BAND 2: 500Hz
 BAND 3: 1600Hz
 BAND 4: 5000Hz
 HIGH CUT and HIGH SHELF: 20000Hz
- Q: Controls the filter Q (width/sharpness or smoothness for low/high cut filters) from 0.1 to 10. Defaults are all 0.71.
- GAIN: Controls filter gain from -12dB to +12dB. Defaults are all 0dB.
- Volume: Sets the global EQ output from 0 to 100. Default is 50.

Please note:

- Please carefully set global EQ parameters for protecting your devices and ears
- USB Audio will **NOT** affected by global EQ
- If a band doesn't work, please check whether the band is on or not
- Reset button will reset **ALL** global EQ parameters
- If you're using patches/effects (like reverbs) need a lot of DSP power, in this case, turning on global EQ may cause system overload

Customizing Your Ampero II Stomp

Display

This menu setup display modes and system UI language.



Use **DISPLAY MODE** to switch between two display modes:

Mode 1: The default display mode which stresses patch number:



Mode 2: Stresses patch name:

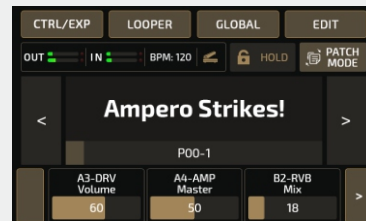

Use **LANGUAGE** to switch system UI language.

Use **COLOR** to choose from 7 system UI colors.

DISPLAY TIME lets you set how long screen display lasts for energy saving. Selections are Always On, 1min, 5min, 10min, 20min, 30min, 40min, 50min, 60min. Default is 30min. When screen display goes out, any operation (e.g. touch the screen, plug in cables, press any footswitch) will wake up the screen.

About

About will show you information about Ampero II Stomp's firmware and hardware.

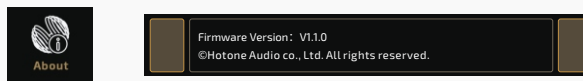

Factory Reset



Use this menu to perform a factory reset. Remember, resetting Ampero II Stomp will delete all of your saved changes and personal settings. Once it is executed, it cannot be undone, so please back up your settings before performing a factory reset.

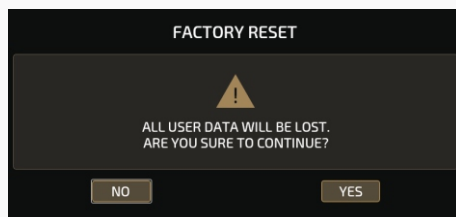

After pressing Factory Reset, this display will come up with a warning. Pressing YES will perform the factory reset. Pressing NO will return to the previous menu.



After continuing with the factory preset, this screen will appear showing that reset is in progress. Do not disconnect the power supply while the reset is in progress. Disconnecting the power supply may cause Ampero II Stomp to malfunction.

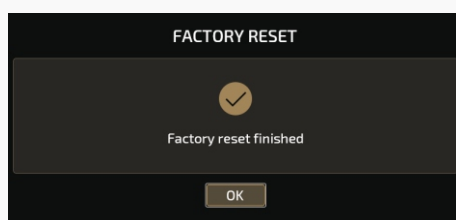

When the factory reset is complete, this message will appear. Press OK to return to the main menu.

Suggested Setups

Here are some common setups to get the most out of Ampero II Stomp.

Using with your instrument and amp

Plug your instrument into the unit's input L jack (or L+R if stereo connection is needed), and run a cable (or two) from the output jack(s) to your amplifier(s). If you have one amp, run the cable from the left output.

For best results, we recommend not to use AMP and CAB modules. You can add a PRE AMP module if you need more tonal flexibilities.

When using with FX Loop jacks, please remember to add FX Loop related modules (FX SND/RTN/LOOP) or setup input/output nodes properly.

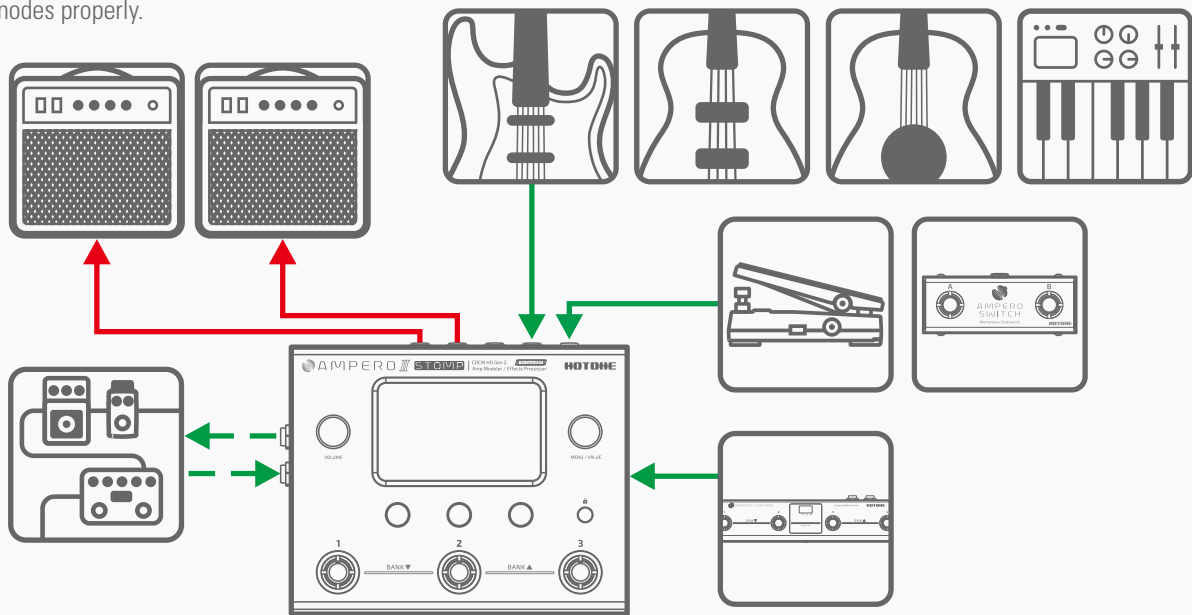

Connecting to your amp's RETURN or Power Amp (Loudster)/FRFR cabinet INPUT

Connect the outputs to your amp's FX Loop Return input or power amp input. If you have one amp, run the cable from the left output.

When using with non-FRFR amps, for best results, turn off the CAB module on Ampero II Stomp.

Sometimes, the AMP module may sound harsh or boomy when running through FX Loop Return jack on some amps. In this case, use PRE AMP module instead of AMP module.

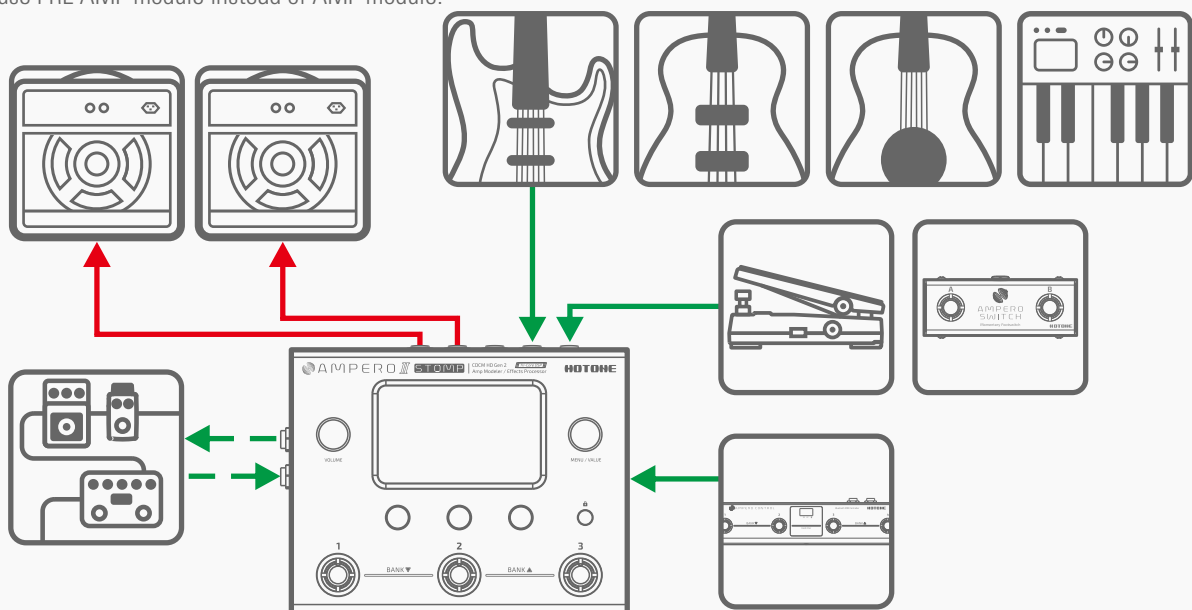

Suggested Setups

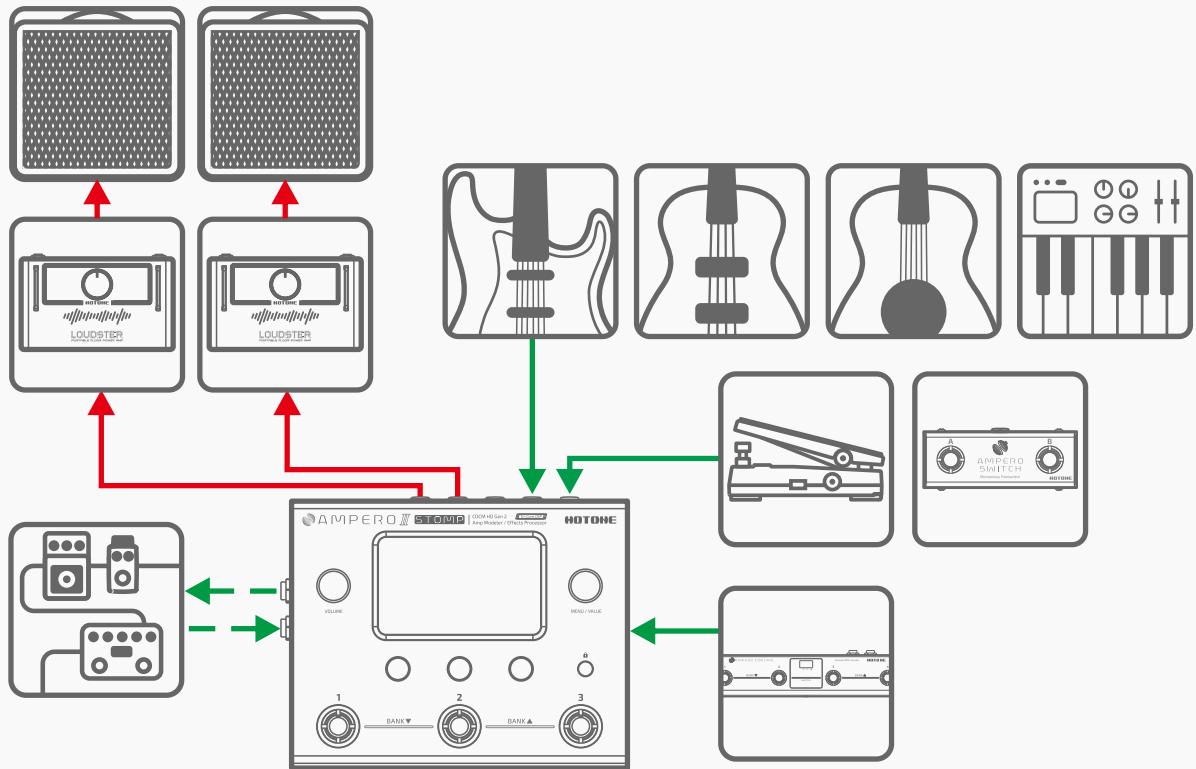

Connecting pedalboards

Set your Ampero II Stomp into your pedalboard, then connect other pedals/controller depending on I/O configurations. When Ampero II Stomp is used as your core gear, if you're using FX loop jacks, please make sure FX loop related modules/nodes are properly set.

Please adjust patch volume properly or volume drop will occur when bypassing/engaging your Ampero II Stomp like a pedal. Please remember bypass mode (DSP/Analog) may alter the tone a lot (e.g. connected in front of a fuzz pedal). If tonal issue (which may be caused by impedance mismatch) occurs, try to switch to a different bypass mode.

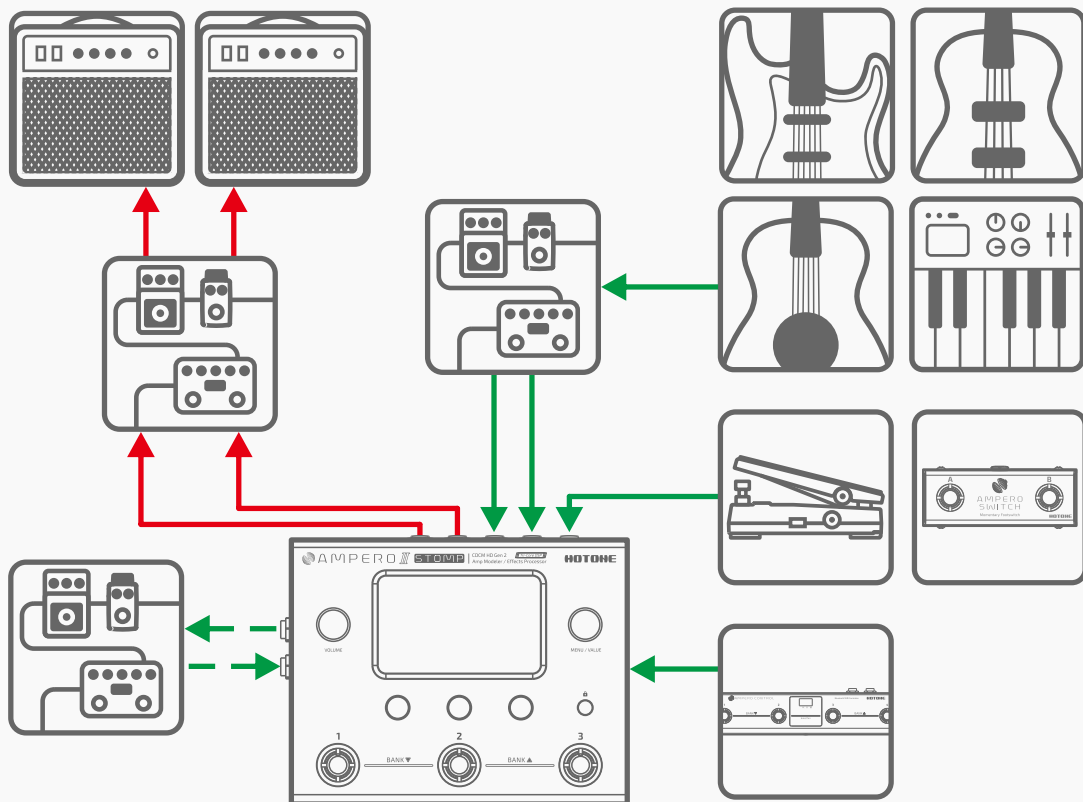

Suggested Setups

Connecting your mixer, interface, headphones, and other equipment

Connect Ampero II Stomp's outputs to your mixer or audio interface's corresponding inputs. We recommend you use balanced connection (TRS cables or TRS to XLR cables are needed) for optimal signal to noise ratio. If you want to send a mono signal out, use Ampero II Stomp's left output channel. To prevent damage to your equipment, make sure the mixer or interface channel's volume is muted before making any connections.

Turn the output volume all the way down before connecting headphones to prevent harm to your ears. Ampero II Stomp's headphones out comes with hi-fi stereo sound.

For best results, please use AMP/PRE AMP and CAB modules.

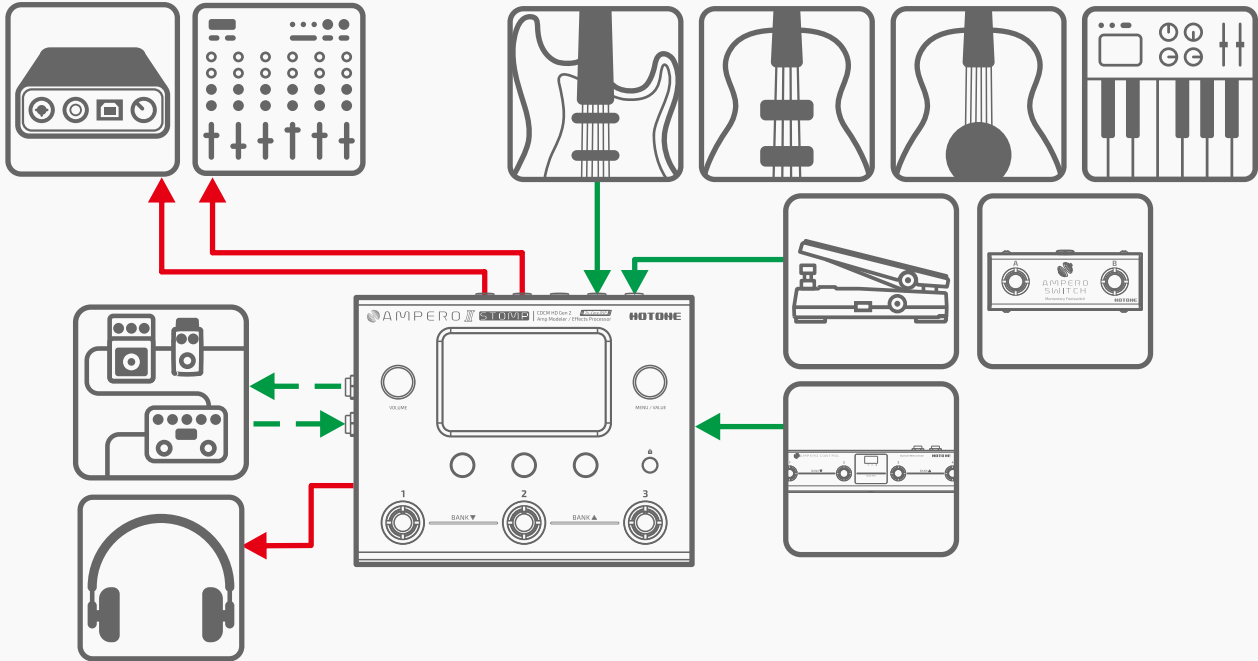

Connecting to your computer as an audio interface

Connect a USB cable from Ampero II Stomp to your computer. For PC systems, you'll need to set up the driver. Ampero II Stomp is plug and play for macOS. Run line out cables to your monitors, or use headphones.

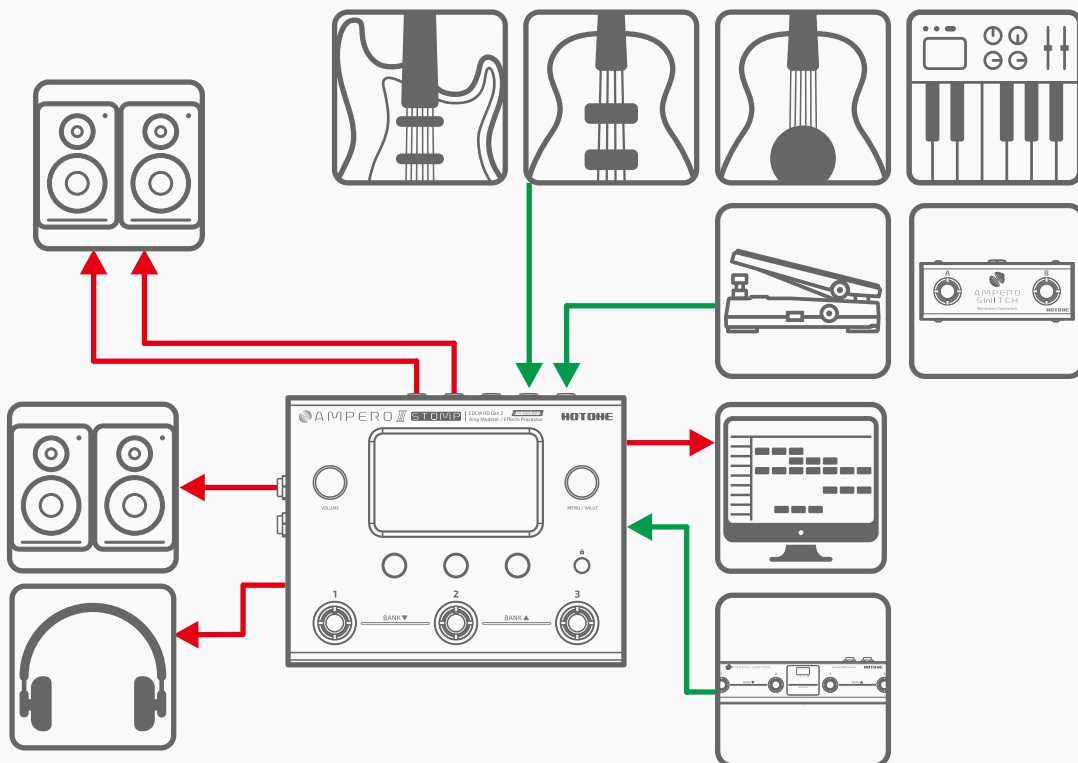

Suggested Setups

Using the AUX IN line

Connect a male-to-male 1/8" stereo cable from your audio source (phone or music player) to Ampero II Stomp's AUX IN jack. This line will be unaffected by Ampero II Stomp's internal effects and USB audio.

Note: if you are running a mono line out, you will only hear a mono version of your AUX source.

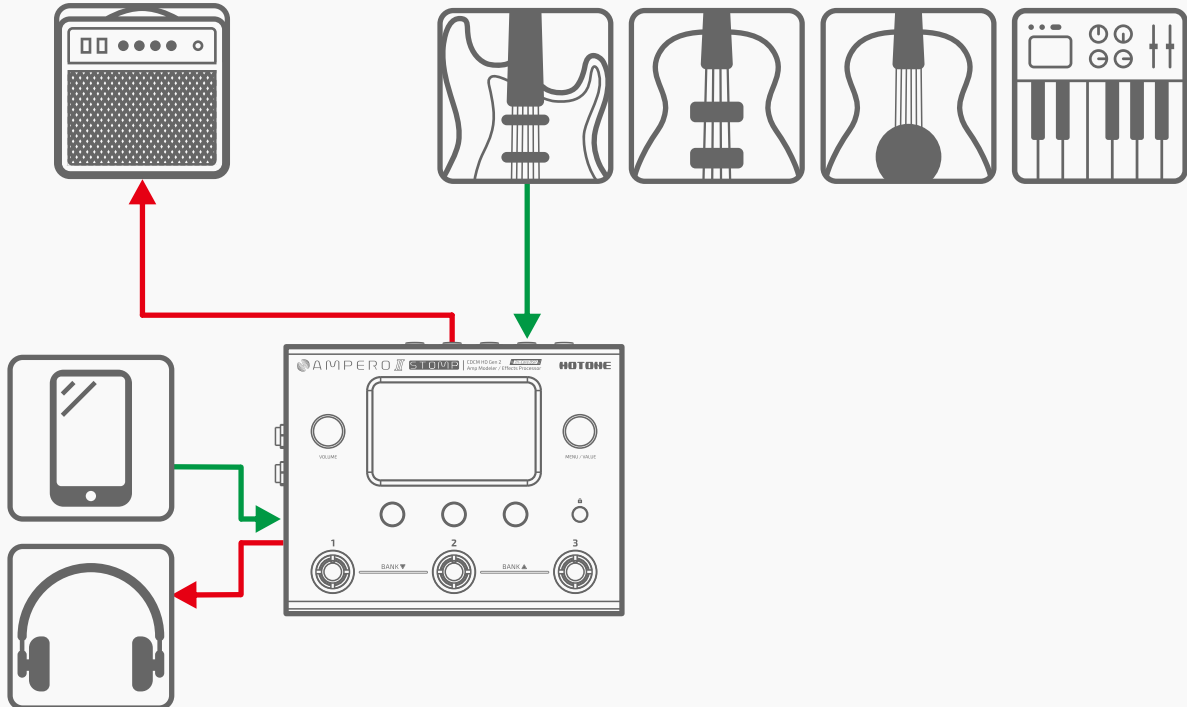

The Editor

Connect Ampero II Stomp to your computer and access the free software to manage your device, adjust tonal settings, transfer files, update firmware, and upload third party IR files. Ampero II Stomp editor is compatible with Windows and macOS platforms. Log on to www.hotoneaudio.com/support to download the free software--it's easy to install and comes with a user manual.



Effect List

Effect Models List

Signal processing:

Mono I/O: Process left channel signal only when inputting stereo signal

Mono in, stereo out: Process left channel signal only when inputting stereo signal

Stereo I/O: Processes both mono/stereo inputs

FX Title	Description	Parameters & Ranges	Signal Processing
Dynamic(17)			
Compressor(4)			
Comprossor	The Holy Grail of compressor pedals is here. Comprossor is based on the legendary Ross™ Compressor* pedal, which is unarguably the compressor of compressors. We carefully recreated the sonic character to get the same colorful, bouncy, natural compression as the original pedal.	Sustain: Controls the compression amount Output: Controls the effect output	Mono I/O
Comparoma 4	The wonderful aroma of compression. Based on the famous Keeley® C4 4-knob compressor* pedal, the Comparoma 4 delivers a silky, bouncy, studio grade compression sound.	Sustain: Controls the compression amount Attack: Controls how soon the compressor starts to process the signal Output: Controls the effect output Clipping: Controls the input sensitivity	
Blue Sustainer	The Blue Sustainer is based on the legendary 3-knob compressor/sustainer pedal, which produces warm, natural compression with long sustain and some gentle clipping.	Sustain: Controls the compression amount Attack: Controls how soon the compressor starts to process the signal Output: Controls the effect output	
Squeezer	A compressor effect reduces the dynamic range of your signal and makes your sound much stronger. The Squeezer is a fully-functional compressor with lots of tonal flexibility. A Tone knob is specially designed for further tone shaping.	Threshold: Controls the compression trigger level Ratio: Controls the amount of compression when the compressor is triggered Output: Controls the output volume/makeup amount Attack: Controls how soon the compressor starts to process the signal Release: Controls how soon the compressor starts to release the signal level back to normal after the level drops below the threshold Tone: Controls the effect tone Blend: Controls the wet/dry signal ratio	
Boost(10)			
Affinity Boost	The Affinity Boost pumps up that sweet sound you've found in your amp. Based on the famous Xotic® AC Booster* pedal, it serves up a wide ranged sound character with power and sensitivity. Or use it as an overdrive to get a sweet, classic tube-like drive with a "wide open" feel.	Gain: Controls the gain amount Volume: Controls the effect output	Mono I/O
Beefy Boost	If you're going to have a steak, you want it big and juicy. The Beefy Boost is based on the classic Xotic® BB Preamp* pedal. It serves up a wide ranged sound character, giving you a boost of encouraging lows and inspiring highs. Or use it as an overdrive to get a thick, juicy "overdriven steak" with a little compression.	Bass/Treble: 2-band EQ that controls the effect tone	

*The manufacturers and product names mentioned above are trademarks or registered trademarks of their respective owners. The trademarks were used merely to identify the sound character of the products.

Effect List

Effect Models List

FX Title	Description	Parameters & Ranges	Signal Processing
Pristine Boost	The Pristine Boost features a unique “no character” character. Based on the famous Xotic® RC Booster* pedal, it offers a super transparent clean boost and a powerful active 2-band EQ so you can maintain your original tonal flavor. Simply put it in your pedal chain, tune up, and leave it on!	Gain: Controls the gain amount Volume: Controls the effect output Bass/Treble: 2-band EQ that controls the effect tone	Mono I/O
Forest Boost	The Forest Boost is based on the Fortin® Grind* booster pedal, providing a max. +20dB boost amount. It helps tighten up your tone while adding some aggressive edges.	Gain: Controls the effect output/boost amount	
Treble Ranger	This model is based on one of the world’s most iconic effect units: the Dallas Rangemaster™2 Treble Booster. Born in 1965, the unit was intended to work as a preamp to get the guitarist more gain and treble. Connect it to a dark UK-style amp, plug in an LP-style guitar, and you get the magical tone the 1960s UK guitar heroes depended on.	Gain: Controls the gain amount	
Gated Boost	Our Gated Boost is designed for modern Dentlemen and metalheads who need huge gain but not noisy artifacts. A built-in noise gate reduces hum and keeps your palm muting tight. Use the Low Cut knob to get your tone where you want it.	Boost: Controls the boost amount Gate: Controls the noise gate threshold Low Cut: Cuts the low frequency signal	
Micro Boost	The Micro Boost is based on the legendary MXR® M133 Micro Amp2 pedal. Providing up to 20dB of gain, the Micro Boost elevates your amp sound without changing its tonal character.	Gain: Controls the gain amount	
Creamy	This is a special tone simulator that simulates the legendary “Woman Tone” created by Eric Clapton during his Cream years. The tone is thick, sustaining, kazoo-like but maintaining note definition and enough attack.	Gain: Controls the thickness	
FET Boost	Based on the legendary FET-based belt clip preamp, this FET boost is a clean volume machine. Use this pedal to get a huge amount of gain without any distortion, tone sculpt with the flexible 2-band EQ. Onboard you’ll also find a handy low cut filter for tone shaping and eliminating low frequency feedback.	Volume: Controls the effect output Bass/Treble: 2-band EQ that controls the effect tone Low Cut: Switches the low cut filter (-6dB/oct @200Hz) on/off	
Enhancer	The Enhancer is based on the Xotic® EP Booster* pedal. This pure booster is the key to unlocking MASTER sounds. With expanded frequency response and increased dynamic range, this pedal enhances the vitality of everything you run into it.	Gain: Controls the effect output/boost amount +3dB: Selects the minimum boost amount from 0dB (off) to +3dB (on) Bright: Selects the sound character from vintage (Bright off) to flat (Bright on)	
Noise Gate(3)			
AI Gate	This model is based on the famous ISP® Decimator™* noise gate pedal. Like the original, the extremely easy-to-use noise gate gets you smooth, ripple-free noise tracking and keeps your signal pristine.	Threshold: Controls the gate trigger level Side Chain: Selects side chain key input source: -Input L/R: Input jacks -FX RTN L/R: FX Loop return jack -Prev FX: Output signal of previous effect slot; if you select this, we recommend you to place the gate before amp/drive effects	Mono I/O

*The manufacturers and product names mentioned above are trademarks or registered trademarks of their respective owners. The trademarks were used merely to identify the sound character of the products.

Effect List

Effect Models List

FX Title	Description	Parameters & Ranges	Signal Processing
Fast Gate	This is a 2-mode noise gate with fast response, which is great for modern Djentlemen and metalheads.	<p>Threshold: Controls the gate trigger level</p> <p>Mode: Selects from two modes: I (responds faster)/II (responds smoother)</p> <p>Side Chain: Selects side chain key input source: -Input L/R: Input jacks -FX RTN L/R: FX Loop return jack</p> <p>-Prev FX: Output signal of previous effect slot; if you select this, we recommend you to place the gate before amp/drive effects</p>	Mono I/O
Custom Gate	This is a fully-functional noise gate with detailed control. The individual Attack and Release controls play nice with amps and other pedals.	<p>Threshold: Controls the gate trigger level</p> <p>Attack: Controls how soon the gate starts to process the signal</p> <p>Release: Controls the noise fade-out duration time after the level drops below the threshold</p> <p>Side Chain: Selects side chain key input source: -Input L/R: Input jacks -FX RTN L/R: FX Loop return jack</p> <p>-Prev FX: Output signal of previous effect slot; if you select this, we recommend you to place the gate before amp/drive effects</p>	
FREQ(44)			
Acoustic (2)			
Acoustic Refiner	Enjoy acoustic refinement: This one-knob tool enhances all that is good in acoustic guitars. It gives a more natural, "woody" tone to your plugged-in acoustic sound, doing wonders for piezo pickups! One knob makes it simple.	<p>Shape: Controls the detailed effect character</p>	Mono I/O
AC Sim	This is an acoustic simulator designed for electric guitars that provides an adjustable range wide enough to give an ordinary electric guitar a variety of natural and realistic acoustic tones.	<p>Body: Controls the "body resonance" (low frequency response)</p> <p>Top: Controls the upper harmonics (high frequency response)</p> <p>Volume: Controls the effect output level</p> <p>Mode: Selects from 4 different sound characters: -Standard: Simulates the tonal characteristics of a standard acoustic guitar -Jumbo: Simulates the tonal characteristics of a jumbo acoustic guitar -Enhanced: Simulates the tonal characteristics of an acoustic guitar with enhanced attack -Piezo: Simulates the sound of a piezo pickup</p>	
Filter(11)			
Low Pass	This is a low pass filter that lets the lows go and attenuates the highs.	<p>Gain: Controls the filter gain by ± 12dB</p> <p>Frequency: Controls the filter center frequency</p> <p>Q: Controls the filter Q</p> <p>Level: Controls the effect output</p>	
Band Pass	This is a band pass filter that lets a selected frequency range go and attenuates others.		
High Pass	This is a high pass filter that lets the highs go and attenuates lows.		

²The manufacturers and product names mentioned above are trademarks or registered trademarks of their respective owners. The trademarks were used merely to identify the sound character of the products.

Effect List

Effect Models List

FX Title	Description	Parameters & Ranges	Signal Processing
Notch	This is a notch filter that boosts/cuts selected frequency range. The filter shape is very narrow so you can use it to accurately eliminate unwanted feedback or fine tune your tone.	Gain: Controls the filter gain by ± 12 dB Frequency: Controls the filter center frequency Q: Controls the filter Q Level: Controls the effect output	Mono I/O
Peak	This is a peak filter that boosts/cuts a certain frequency range. Like a frequency band on a parametric EQ, this model is great tool for tone shaping.		
Low Shelf	This is a low shelf filter that boosts/cuts signal below a set frequency which is great for effectively boosting/eliminating low ends.		
High Shelf	This is a high shelf filter that boosts/cuts signal above a set frequency which is great for effectively boosting/eliminating low ends.		
Tilt EQ	This is a tilt filter, a quick tool for tone sculpting. Like a seesaw, it boosts the signal above a set frequency and cuts the signal below it, or vice versa.		
Moo VCF LP	This is a low pass filter that lets the lows go and attenuates the highs. Inspired by the legendary Moog® VCF*, it gives you a lot of fun to use with synths, and it's also great on guitar/bass to create something synth-y.	Cutoff: Controls the cutoff frequency Reso: Controls the filter resonance Level: Controls the effect output	Mono I/O
Moo VCF BP	This is a band pass filter that lets a selected frequency range go and attenuates others. Inspired by the legendary Moog® VCF*, it gives you a lot of fun to use with synths, and it's also great on guitar/bass to create something synth-y.	Freq: Controls the filter center frequency Reso: Controls the filter resonance Level: Controls the effect output	
Moo VCF HP	This is a high pass filter that lets the highs go and attenuates the lows. Inspired by the legendary Moog® VCF*, it gives you a lot of fun to use with synths, and it's also great on guitar/bass to create something synth-y.	Cutoff: Controls the cutoff frequency Reso: Controls the filter resonance Level: Controls the effect output	
Envelope Filter(4)			
Toucher G	Toucher G is an envelope filter designed for guitars, offering you a wide range of tonal variety. Set the Sense, Range, and Q parameters to fit your instrument and playing style.	Sense: Controls the effect sensitivity Range: Controls the filter frequency range Q: Controls the filter sharpness Level: Controls the output level	Mono I/O
Toucher B	Toucher B is an envelope filter designed for basses, offering you a wide range of tonal variety. Set the Sense, Range, and Q parameters to fit your instrument and playing style.	Sense: Controls the effect sensitivity Range: Controls the filter frequency range Q: Controls the filter sharpness Level: Controls the output level	
Moo VCF Env	This is an envelope filter inspired by the legendary Moog® VCF*. This is a lot of fun to use with synths, and it's also great on guitar/bass to create something synth-y.	Sens: Controls the sensitivity Mode: Controls the filter mode Freq: Controls the filter center frequency Q: Controls the filter Q Dry Level: Controls the dry signal amount Level: Controls the effect output	

*The manufacturers and product names mentioned above are trademarks or registered trademarks of their respective owners. The trademarks were used merely to identify the sound character of the products.

Effect List

Effect Models List

FX Title	Description	Parameters & Ranges	Signal Processing
Envelope	This is a highly customizable envelope filter. Fine tune the knobs onboard to make your creations: Funky wah, synth-y vibe, robot talk, cyber voice sweep – You decide!	<p>Sweep: Selects filter sweeping direction Sens: Controls the sensitivity Spread: Controls the filter stereo separation Mode: Controls the filter mode Range: Controls the filter frequency range Freq: Controls the filter frequency range midpoint Q: Controls the filter Q Dry Level: Controls the dry signal amount Level: Controls the effect output</p>	Mono I/O
Auto Filter(7)			
Crier G	<p>The Crier G is a controllable band pass filter which delivers a variety of auto-wah effects. Designed for guitars, this model has many parameters for shaping the tone of your wah sound. Start with the frequency range adjustment to decide the basic flavor of your wah-wah.</p> <p>You can use Tap Tempo function to control the effect speed by turning on the Sync switch. When the Sync switch is on, turn the Rate knob to set a proper tap divide value. The default value is 1/4 (no division).</p>	<p>Wave Shape: Selects the LFO modulation waveform applied to the filter Rate: Controls the effect speed Range: Controls the filter frequency range Level: Controls the output level Q: Controls the sharpness of the filter Sync: Switches Tap Tempo sync on/off</p>	Mono I/O
Crier B	<p>The Crier B is a controllable band pass filter which delivers a variety of auto-wah effects. Designed for basses, this model has many parameters for shaping the tone of your wah sound. Start with the frequency range adjustment to decide the basic flavor of your wah-wah.</p> <p>You can use Tap Tempo function to control the effect speed by turning on the Sync switch. When the Sync switch is on, turn the Rate knob to set a proper tap divide value. The default value is 1/4 (no division).</p>		
LFO Filter	<p>This is a highly customizable LFO-based auto filter. Fine tune the knobs onboard to make your creations.</p> <p>You can use Tap Tempo function to control the effect speed by turning on the Sync switch. When the Sync switch is on, turn the Rate knob to set a proper tap divide value. The default value is 1/4 (no division).</p>	<p>Wave Shape: Selects the LFO modulation waveform applied to the filter Phase: Controls the LFO modulation L/R phase offset Rate: Controls the LFO speed (effect speed) Mode: Controls the filter mode Range: Controls the filter frequency range Freq: Controls the filter frequency range midpoint Q: Controls the filter Q Dry Level: Controls the dry signal amount Level: Controls the effect output Sync: Switches Tap Tempo sync on/off</p>	Stereo I/O

*The manufacturers and product names mentioned above are trademarks or registered trademarks of their respective owners. The trademarks were used merely to identify the sound character of the products.

Effect List

Effect Models List

FX Title	Description	Parameters & Ranges	Signal Processing
Vocal Filter	<p>Note: This is a stereo effect with independent L/R signal processing.</p> <p>This is a highly customizable special auto filter providing a human-like tone with two voices. Fine tune the knobs onboard to make your creations.</p> <p>You can use Tap Tempo function to control the effect speed by turning on the Sync switch. When the Sync switch is on, turn the Rate knob to set a proper tap divide value. The default value is 1/4 (no division).</p>	<p>Wave Shape: Selects the LFO modulation waveform applied to the filter</p> <p>Vowel 1/2: Selects the filter type (vowel)</p> <p>Phase: Controls the LFO modulation L/R phase offset</p> <p>Depth: Controls the effect depth</p> <p>Rate: Controls the LFO speed (effect speed)</p> <p>Level: Controls the effect output</p> <p>Sync: Switches Tap Tempo sync on/off</p>	Mono in, stereo out
Path Filter 4	<p>This model is a 4-step filter machine for creating synth-like sounds. Each step features an individual frequency control, and a rate control sets the sequencing speed.</p> <p>You can use Tap Tempo function to control the effect speed by turning on the Sync switch. When the Sync switch is on, turn the Rate knob to set a proper tap divide value. The default value is 1/4 (no division).</p>	<p>Step 1-4: Controls the filter center frequency of each step</p> <p>Rate: Controls the sequencing speed</p> <p>Sync: Switches Tap Tempo sync on/off</p>	Mono I/O
Path Filter 8	<p>This model is a 8-step filter machine for creating synth-like sounds. Each step features an individual frequency control, and a rate control sets the sequencing speed.</p> <p>You can use Tap Tempo function to control the effect speed by turning on the Sync switch. When the Sync switch is on, turn the Rate knob to set a proper tap divide value. The default value is 1/4 (no division).</p>	<p>Step 1-8: Controls the filter center frequency of each step</p> <p>Rate: Controls the sequencing speed</p> <p>Sync: Switches Tap Tempo sync on/off</p>	
Pattern Filter	<p>This model is a pattern filter machine for creating synth-like sounds. It provides max. 8 steps and 8 different patterns. A rate control sets the sequencing speed.</p> <p>You can use Tap Tempo function to control the effect speed by turning on the Sync switch. When the Sync switch is on, turn the Rate knob to set a proper tap divide value. The default value is 1/4 (no division).</p>	<p>Step: Selects the numbers of steps</p> <p>Patten: Selects from 8 different sequencing patterns</p> <p>Rate: Controls the sequencing speed</p> <p>Shape: Controls the filter width</p> <p>Reso: Controls the filter resonance</p> <p>Sync: Switches Tap Tempo sync on/off</p>	
Pitch(14)			
Analog Octa 1	<p>This model is a monophonic octaver that creates notes one octave lower and two octaves lower. Single note processing and individual wet/dry signal control recreate the vintage "dirty" analog octave pedal sounds.</p>	<p>Oct 1: Controls the volume of lower octave (1 oct down)</p> <p>Oct 2: Controls the volume of higher octave (1 oct up)</p> <p>Dry: Controls the dry signal level</p>	Mono I/O
Analog Octa 2	<p>This model is a monophonic octaver that creates notes one octave lower and two octaves lower. Single note processing and individual wet/dry signal control recreate the vintage "dirty" analog octave pedal sounds.</p>		

*The manufacturers and product names mentioned above are trademarks or registered trademarks of their respective owners. The trademarks were used merely to identify the sound character of the products.

Effect List

Effect Models List

FX Title	Description	Parameters & Ranges	Signal Processing
Digital Octa	Note: This is a stereo effect with independent L/R signal processing. This model is a polyphonic octaver that creates notes one octave higher and one octave lower. Individual octave voice control and dry signal control can bring you lots of fun, and polyphonic processing support means playing chords is absolutely no problem.	Hi Level: Controls the volume of higher octave (1 oct up) Low Level: Controls the volume of lower octave (1 oct down) Hi/Lo Pan: Controls the higher/lower octave signal L/R panning Tone: Controls the effect tone Mix: Controls the wet/dry signal ratio	Mono in, stereo out
Dual Pitch	Note: This is a stereo effect with independent L/R signal processing. This model is a polyphonic 2-voice pitch shifter with max. 2 octaves pitch shifting range. Detailed pitch shifting settings can bring you lots of fun.	Pitch 1/2: Controls the voice 1/2 pitch shifting range by ± 24 semitones Detune 1/2: Fine tunes the pitch correction by ± 50 cents Delay 1/2: Controls the time between dry and wet signals Pan 1/2: Controls the wet signal L/R panning Tone: Controls the effect tone Mix: Controls the overall dry/wet signal ratio Level 1/2: Controls the effect output Output: Controls the overall output	
Quad Pitch	Note: This is a stereo effect with independent L/R signal processing. This model is a polyphonic 4-voice pitch shifter with max. 2 octaves pitch shifting range. Detailed pitch shifting settings can bring you lots of fun.	Pitch 1-4: Controls the voice 1-4 pitch shifting range by ± 24 semitones Detune 1-4: Fine tunes the pitch correction by ± 50 cents Delay 1-4: Controls the time between dry and wet signals Pan 1-4: Controls the wet signal L/R panning Tone: Controls the effect tone Mix: Controls the overall dry/wet signal ratio Level 1-4: Controls the effect output Output: Controls the overall output	
Classic PS	This model is a monophonic pitch shifter with max. 2 octaves pitch shifting range, simulating the classic Whammy®* tone. Assign the Position parameter to your expression pedal, turn the expression pedal on, and you can bend the pitch by moving the pedal back and forth.	Range: Selects the pitch shifting range Position: Controls the pedal position (min=0, max=100) Tone: Controls the effect tone Level: Controls the effect output	Mono I/O
Pitch Shift	This model is a polyphonic pitch shifter with max. 2 octaves pitch shifting range. Individual mix/max pitch range settings can bring you lots of fun. Assign the Position parameter to your expression pedal, turn the expression pedal on, and you can bend the pitch by moving the pedal back and forth.	Min/Max Pitch: Controls the low/high pitch shifting range by ± 24 semitones Position: Controls the pedal position (min=0, max=100) Tone: Controls the effect tone Level: Controls the effect output	
Detune	This is a detune model which combines a slightly pitch shifted signal with the original signal, producing a lush, chorus-like sound. Use the Dry, Wet and Detune knobs to expand your sonic dimensions.	Dry/Wet: Controls the dry/wet signal level Detune: Controls the detune amount by ± 50 cents	Mono in, stereo out

*The manufacturers and product names mentioned above are trademarks or registered trademarks of their respective owners. The trademarks were used merely to identify the sound character of the products.

Effect List

Effect Models List

FX Title	Description	Parameters & Ranges	Signal Processing
Dual Detune	Note: This is a stereo effect with independent L/R signal processing. This is a dual-voice detune effect combines two slightly pitch shifted voices with the original signal, producing a lush, chorus-like sound. Use the control knobs to expand your sonic dimensions.	Detune 1/2: Controls the detune amount by ± 50 cents Delay 1/2: Controls the time between dry and wet signals Pan 1/2: Controls the wet signal L/R panning Tone: Controls the effect tone Mix: Controls the overall dry/wet signal ratio Level 1/2: Controls the effect output Output: Controls the overall output	Mono in, stereo out
Quad Detune	Note: This is a stereo effect with independent L/R signal processing. This is a quad-voice detune effect combines four slightly pitch shifted voices with the original signal, producing a lush, chorus-like sound. Use the control knobs to expand your sonic dimensions.	Detune 1-4: Controls the detune amount by ± 50 cents Delay 1-4: Controls the time between dry and wet signals Pan 1-4: Controls the wet signal L/R panning Tone: Controls the effect tone Mix: Controls the overall dry/wet signal ratio Level 1-4: Controls the effect output Output: Controls the overall output	
80s Detune	This is a detune effect simulates the detune effect coming from THAT legendary 1980s red pitch bend pedal. Great for producing 1980s tone.	Mode: Selects from two detuning modes	Mono I/O
String Shifter	This model is a polyphonic pitch shifter. You can use it as a virtual capo, or use it to simulate down tunings on your guitar.	Shift: Controls the pitch shifting range by ± 12 semitones Detune: Fine tunes the pitch correction by ± 50 cents Volume: Controls the effect output	
Harmonizer 1	This model is a monophonic single voice automatic harmonizer with max. one octave pitch shifting range. Detailed Key, Scale and Interval settings can bring you lots of fun.	Mix: Controls the wet/dry signal ratio of the effect Key: Selects the chord key according to your music Mode: Selects the scale mode according to your music Interval: Selects the interval between wet and dry signal Smooth Mode: Switch on to get a smooth note transition	
Harmonizer 2	This model is a monophonic dual voice automatic harmonizer with max. one octave pitch shifting range. Detailed Key, Scale and Interval settings can bring you lots of fun.	Mix: Controls the wet/dry signal ratio of the effect Key: Selects the chord key according to your music Mode: Selects the scale mode according to your music Interval 1/2: Selects the interval between wet and dry signal Smooth Mode: Switch on to get a smooth note transition	
Special(6)			
12-Stringer	This model makes an ordinary guitar play like a 12-string guitar. One knob makes it easy to use.	Output: Controls the effect output	Mono in, stereo out
Bit Krusher	This model is a sweet-sounding bitcrusher/sample rate reducer with full control over the bit resolution and sample rate. Use the low pass filter and high pass filter onboard to get your own sound variations.	Mix: Controls the wet/dry signal ratio of the effect Krush: Controls the sample rate of the effect Bit: Controls the bit resolution of the effect Hi Cut: Controls the cutoff frequency of the high cut filter Lo Cut: Controls the cutoff frequency of the low cut filter	Mono I/O
Ring Mod	This is a ring modulator which produces interesting inharmonic frequency spectra. The Freq, Tone and Mix controls are tweak up unique bell and chime effects, and a Fine knob gives you extra control over the frequency.	Mix: Controls the wet/dry signal ratio Freq: Controls the overall modulation frequency Fine: Fine tune the modulation frequency by ± 50 Hz Tone: Controls the effect tone	

*The manufacturers and product names mentioned above are trademarks or registered trademarks of their respective owners. The trademarks were used merely to identify the sound character of the products.

Effect List

Effect Models List

FX Title	Description	Parameters & Ranges	Signal Processing
Telephone Line	This special filter makes you sound like you're playing over an old phone. Tweak the Noise and Shake knobs to get a seriously iffy connection.	Noise: Controls the background noise amount Shake: Controls the sound vibration	Mono I/O
Satisfaction	Can't get no satisfaction! This model is a tape saturation simulator that simulates the sound character of a vintage reel-to-reel tape recorder, bringing you unbeatable analog warmth and natural distortion.	Saturation: Controls the effect gain Mix: Controls the effect wet/dry signal ratio Output: Controls the effect output volume High Cut: Cuts the effect high frequency signal	
Mic Lab	This filter is a vintage microphone simulator that makes you sound like you're rocking through a pre-war microphone. Use the Mic Type knob to pick the sound you like best.	Mic Type: Selects from three different sound characters Gain: Controls the output level	
WAH(13)			
Assign the Position parameter to your expression pedal, turn the expression pedal on, and you'll hear the difference by moving the pedal back and forth.			
Clay Wah	This model is based on the legendary vintage VOX® Clyde McCoy®* wah pedal, reproducing the voice-y expressive wah tone.	Range: Controls the wah filter frequency range Q: Controls the wah resonance (filter Q) Volume: Controls the effect output Position: Controls the wah pedal position (min=fully heel, max=fully toe)	Mono I/O
Voxy Wah	This model is based on the VOX® V845* wah pedal, bringing you the heart and the soul of the golden wah-wah tone.		
Voxy Wah+	This model is based on the vintage VOX® V846* wah pedal, bringing you the heart and the soul of the golden wah-wah tone.		
Color Wah	This model is based on the vintage Colorsound® Wah-Wah* pedal, bringing you the heart and the soul of a golden British wah-wah tone.		
Funky Wah	This model is inspired by the legendary "Shaft" sound, which is great for funky music.		
Magic Wah	This model is based on the Morley® Power Wah*, bringing you the iconic Morley®* wah tone that was popular since 1970s.		
Soul Press	This model is based on the WAH mode of our best-selling 3 in 1 mini pedal: Soul Press.		
Bass Press	This model is a bass wah that based on the WAH mode of our best-selling 3 in 1 pedal: Bass Press.		
Cry Wah	This model is based on the legendary Dunlop® CryBaby®* wah pedal, bringing you the iconic deep, rich tonal sweep.		
Cry Wah+	This model is based on the legendary Dunlop® CryBaby® 535Q* wah pedal, a versatile wah with detailed tone control.		

*The manufacturers and product names mentioned above are trademarks or registered trademarks of their respective owners. The trademarks were used merely to identify the sound character of the products.

Effect List

Effect Models List

FX Title	Description	Parameters & Ranges	Signal Processing
Petrus Wah	This model is based on the Dunlop® JP95 John Petrucci CryBaby®* wah pedal that customized on John Petrucci's demands. The built-in EQ is fixed to default.	Range: Controls the wah filter frequency range Q: Controls the wah resonance (filter Q) Volume: Controls the effect output Position: Controls the wah pedal position (min=fully heel, max=fully toe) EQ: Switches built-in EQ on/off	Mono I/O
Sandman Wah	This model is based on the Dunlop® KH95 Kirk Hammett CryBaby®* wah pedal that customized on Kirk Hammett's demands.	Range: Controls the wah filter frequency range Q: Controls the wah resonance (filter Q) Volume: Controls the effect output Position: Controls the wah pedal position (min=fully heel, max=fully toe)	
Chili Wah	This model is based on the Ibanez® WH-10* wah pedal, producing a creamy 80's wah tone that beloved by RHCP's John Frusciante.	Range: Controls the wah filter frequency range Q: Controls the wah resonance (filter Q) Volume: Controls the effect output Position: Controls the wah pedal position (min=fully heel, max=fully toe) Mode: Switches between guitar and bass modes Depth: Controls the wah filter intensity	
DRV(33)			
Overdrive(17)			
Green Drive	This model is based on the legendary Ibanez® TS-808 Tube Screamer®*. Featuring a warm, juicy overdriven sound, this Green Drive is the incomparable vintage overdrive model you've always been hoping to find.	Gain: Controls the overdrive amount Tone: Controls the effect tone Volume: Controls the effect output	Mono I/O
Green 9	This model is based on the legendary Ibanez® TS-9 Tube Screamer®*, which was originally designed to simulate the sound of a vintage tube amplifier. Like the original, the Green 9 model has a rich, smooth and natural overdriven sound, and it won't lose any detail of your playing.		
Yellow Drive	Based on pretty much the first overdrive pedal the world ever saw, Yellow Drive brings you the iconic beefy, cream-like overdriven sound with pronounced details and a wide dynamic response range. NO TONE CONTROL – YOU WON'T NEED IT!	Gain: Controls the overdrive amount Volume: Controls the effect output	
Swarm Drive	Based on the Providence® SOV-2 Stampede OD* pedal, this model delivers the natural overdrive tone without affecting the inherent sound character of your guitar. No matter what you need – from crunchy rhythms to singing solos, the Swarm Drive will never let you down.	Gain: Controls the overdrive amount Tone: Controls the effect tone Volume: Controls the effect output	
Super Drive	This Super Drive is based on a classic, widely used overdrive which features a unique asymmetric overdrive circuitry. Delivering a rich, authentic-sounding tube-driven overdrive effect with wide tonal range, it's one of a must-have overdrive model in your effect chain.	Gain: Controls the overdrive amount Tone: Controls the effect tone Volume: Controls the effect output	

*The manufacturers and product names mentioned above are trademarks or registered trademarks of their respective owners. The trademarks were used merely to identify the sound character of the products.

Effect List

Effect Models List

FX Title	Description	Parameters & Ranges	Signal Processing
Screamood	The Screamood model is a classic overdrive inspired by the evergreen TS-style overdrive served with its most enduring modification. Use the two onboard switches to find your favorite screaming mood.	Gain: Controls the overdrive amount Volume: Controls the effect output Tone: Controls the effect tone Fat: Switches extra resonance on/off Air: Switches extra presence on/off	Mono I/O
Dr. Blues	Based on the widely used blues overdrive (and the famous PHAT-modified version), Dr. Blues is a roadmap of classic bluesy textures to take you from sweet Tennessee to screaming Texas. Turn up the GAIN knob to get a warm distortion with tons of sensitivity and a wide frequency response. It works great on bass too!	Gain: Controls the distortion amount Tone: Controls the effect tone Volume: Controls the effect output	
Force Drive	Based on the legendary Fulltone® OCD®* overdrive pedal, this model gives you that great amp-like flavor of a cranked up vintage amp. Get wild with this responsive, super powerful overdrive monster!	Gain: Controls the distortion amount Tone: Controls the effect tone Volume: Controls the effect output Mode: Selects from two different sound characters: HP (High Peak mode with more bottom end and distortion), LP (Low Peak mode without changing your original tone)	
Tube Clipper	The Tube Clipper is based on the legendary B. K. Butler® Tube Driver®*, the REAL TUBE overdrive with a 12AX7 tube inside. Famous for the violin-like “Cliffs of Dover” tone, it sits atop many a studio pro and live musician’s wish list.	Gain: Controls the distortion amount Volume: Controls the effect output Bass/Treble: 2-band EQ that controls the effect tone	
Blues Butter	This Blues Butter overdrive model recreates the magic of the classic Bluesbreaker®* sound for you. Based on the Marshall® Bluesbreaker®* overdrive pedal, this low-mid-gain overdrive will add sweetness (and a little wildness) to your guitar sound. You can use it as a clean boost too!	Gain: Controls the gain amount Tone: Controls the effect tone Volume: Controls the effect output	
Grand Driver	Based on the legendary Marshall® Drive Master* overdrive pedal, the Grand Driver model offers a 3-band tone control. It is like adding an extra amp with classic British overdrive tone to your set up. This will push your performance to an even higher level!	Gain: Controls the gain amount Volume: Controls the effect output Bass/Middle/Treble: 3-band EQ that controls the effect tone	
Zen Garden	This model is a touch-sensitive overdrive with wide-ranged dynamics. Based on the legendary Hermida® Zendrive®*, the Zen Garden delivers an overdriven tone associated with some of the finest, most costly amplifiers on the market. With the four knobs onboard, you can easily touch the soul of ZEN	Gain: Controls the overdrive amount Tone: Controls the effect tone Volume: Controls the effect output Voice: Controls the upper harmonics character	
Direct Touch	Direct Touch is based on the famous Barber® Direct Drive* overdrive pedal. Delivering sparking tube style overdrive with great clarity, you’ll hear every note singing with pride and joy – just like a real vintage tube amp does!	Gain: Controls the distortion amount Tone: Controls the effect tone Volume: Controls the effect output Harmonics: Switches extra harmonics on/off	

*The manufacturers and product names mentioned above are trademarks or registered trademarks of their respective owners. The trademarks were used merely to identify the sound character of the products.

Effect List

Effect Models List

FX Title	Description	Parameters & Ranges	Signal Processing
Faun Drive	Based on the legendary Klon® Centaur*, this overdrive model gives you an authentic amp-in-a-box feel with full, rich sound character that is not harsh or boomy at all. Turn Gain knob to minimum you get a superb clean boost.		Mono I/O
Amore Eterno	This model is based on the famous Lovepedal® Eternity* overdrive pedal, a Screamer-inspired overdrive that goes beyond the green machine. Same as original, the unique Glass control makes it work great as both overdrive and clean boost. Jump in to that eternal sound beloved by Police's Andy Summers and GNR's Richard Fortus.	Gain: Controls the gain amount Tone: Controls the effect tone Volume: Controls the effect output	
Precise Attack	Precise Attack is a modern booster/overdrive model based on the famous Horizon Devices® Precision Drive*. Designed by Misha Mansoor, this pedal is an everything solution for progressive musicians. Plug in an extended range guitar, or run into a high gain amp to find the prog magic. Special designed Attack control tightens the low ends and makes your sound prog-y. A built-in smart noise gate reduces hum and keeps your palm muting tight.	Gain: Controls the overdrive amount Tone: Controls the effect tone Volume: Controls the effect output Attack: 6-mode selector; dial clockwise for a tighter, more aggressive sound Gate: Controls the built-in noise gate threshold	
Magic T	Magic T is an overdrive model based on the legendary Paul Cochrane Timmy®* overdrive (V2) pedal – one of the first transparent overdrive pedals. Like the original, Magic T pushes your amp/guitar to the limit while maintaining the original flavor and dynamics.	Gain: Controls the overdrive amount Volume: Controls the effect output Bass/Treble: 2-band EQ that controls the effect tone (counterclockwise, same as original) Mode: Selects from three clipping modes: -I: asymmetrical clipping -II: symmetrical clipping -III: symmetrical clipping with more compression feel	
FUZZ(3)			
Big Pie	Many dirt pedals released throughout the 1970s began to blur the lines between fuzz and distortion. The Big Pie is one of them. Based on the legendary Big Muff Pi®*, this model is a fresh take on the fuzz tone territory. You get a wide-ranged sound character using the TONE knob – from creamy overdrive-like sound to really aggressive fuzzy tone.	Sustain: Controls the gain amount Tone: Controls the effect tone Volume: Controls the effect output	Mono I/O
Face Fuzz	This model is based on the legendary Dallas-Arbiter® Fuzz Face®*. Featuring a unique, unmistakable creamy sound with incredible dynamics, the pedal remains a favorite among many rock stars – Hendrix, Gilmour, Townshend and more!	Fuzz: Controls the gain amount Volume: Controls the effect output	
Bend Fuzz	This model is based on the legendary Sola Sound® Tone Bender Mk II®* fuzz pedal – the legend of the legends. We reproduced the smooth, honey-like tone that was beloved by Page and many more professional musicians.		

*The manufacturers and product names mentioned above are trademarks or registered trademarks of their respective owners. The trademarks were used merely to identify the sound character of the products.

Effect List

Effect Models List

FX Title	Description	Parameters & Ranges	Signal Processing
Distortion(10)			
Plustortion	This little yellow box has produced lots of great soundings in countless classic studio albums. Yeah, we're talking the legendary MXR® M104 Distortion +*, and this M104-based Plustortion. The Plustortion recreated the Germanium-powered soft clipping distortion, like what Randy Rhoads and other hard rockers do!	Gain: Controls the distortion amount Volume: Controls the effect output	Mono I/O
Smooth Dist	Based on the famous late-70's distortion pedal that is a favorite among pro guitarists and pedal modifiers, the Smooth Dist is truly a classic distortion model. It produces a distortion sound ranging from screaming loud to whisper soft. Of course, it faithfully reproduces the dynamics of your playing style.	Gain: Controls the distortion amount Tone: Controls the effect tone Volume: Controls the effect output	
Black Tail	Here is another dirt pedal that changed the rules. Based on the ProCo™ RAT2* distortion pedal (early LM308 op-amp version), Black Tail brings you the real underground rock scene. Sweet overdrives, grinding rhythms, roaring solos – Black Tail cashes in with authority and power. Same as the original, Black Tail features the legendary FILTER control: Turn it clockwise to cut off the high end, turn it counterclockwise to allow the natural brightness of your instrument through.	Gain: Controls the distortion amount Filter: Counterclockwise controls the effect tone Volume: Controls the effect output	
Governor	Based on the legendary Marshall® The Guv'Nor* distortion pedal which was well known for its high quality and iconic British distortion tones, it recreated the world-famous drive sound of a classic Marshall® stack at full tilt.	Gain: Controls the distortion amount Volume: Controls the effect output Bass/Middle/Treble: 3-band EQ that controls the effect tone	
Shredder	The Shredder is based on the legendary Marshall® Shred Master* distortion pedal, the one well known for used by Radiohead's Jonny Greenwood to create his twisted distortion walls.	Gain: Controls the distortion amount Volume: Controls the effect output Bass/Middle/Treble: 3-band EQ that controls the effect tone	
Crunchist	Based on the MI Audio® Crunch Box®*, this model brings you high-gain British amp distortion in a stompbox. Simple and straightforward, with just gain, tone, and volume control, the Crunchist distortion easily recreates the huge crunch of a British amp.	Gain: Controls the distortion amount Tone: Controls the effect tone Volume: Controls the effect output	
Metaland	Metaland Distortion provides an insanely heavy distortion with edgy highs, powerful mids and heavy lows. Inspired by the world's most popular heavy metal distortion pedal, the Metaland is definitely an extreme "dirt wall" creator.	Gain: Controls the distortion amount Volume: Controls the effect output Bass/Middle/Treble: 3-band EQ that controls the effect tone Mid Freq: Controls the range of middle frequency	

*The manufacturers and product names mentioned above are trademarks or registered trademarks of their respective owners. The trademarks were used merely to identify the sound character of the products.

Effect List

Effect Models List

FX Title	Description	Parameters & Ranges	Signal Processing
Rebel	Go and get your riot gear! Rebel is based on the famous Suhr® Riot Distortion™* pedal, characterized by massive distortion that maintains touch sensitivity. Now you've got an authoritative shredding and riffing machine just a kick away!	Gain: Controls the gain amount Tone: Controls the effect tone Volume: Controls the effect output Voice: Selects from three different sound characters: -Natural: Neutral sound -Tight: A tighter, more aggressive sound -Vintage: A smoother, warmer sound	Mono I/O
Pleximaker	Here's another great 80s lead sound: Based on the famous Wampler® Plexitortion* pedal, this Pleximaker does exactly what you think: kick it on to get hot-rodded British lead amp tone.	Gain: Controls the distortion amount Mode: Selects from two different sound characters: Vintage/Modern Volume: Controls the effect output Bass/Middle/Treble: 3-band EQ that controls the effect tone	
Panama Lead	The Panama Lead is a distortion model inspired by the legendary "brown sound" amp. This distortion takes your brown lead all the way from raw to relentless.	Gain: Controls the distortion amount Tone: Controls the effect tone Volume: Controls the effect output Tight: Controls the low bottom resonance	
Bass Drive(3)			
Solid Steel	Solid Steel is a flexible drive pedal designed for bass. We voiced this one to deliver a rich driven bass sound. Use the Mode knob to select from 3 unique sound characters.	Gain: Controls the overdrive amount Tone: Controls the effect tone Volume: Controls the effect output Mode: Selects from 3 different sound characters: Normal (neutral sound), Scoop (mid-scooped sound), Edge (edgy sound) Blend: Controls the wet/dry signal ratio	Mono I/O
Bass OD	If you're looking for an all-around bass driver, this is the one. Based on the widely used yellow bass driver, the Bass OD gives you a massive bass sound with super wide tonal flexibility.	Gain: Controls the distortion amount Blend: Controls the wet/dry signal ratio Volume: Controls the effect output Bass/Treble: 2-band EQ that controls the effect tone	
Behemoth M	The Behemoth M is based on the famous Darkglass® Microtubes B7K Analog Bass Preamp* pedal. This pedal can turn your whispering bass into a growling monster, all while preserving the clarity. Onboard EQ gives you wide tonal flexibility.	Gain: Controls the overdrive amount Blend: Controls the wet/dry signal ratio Volume: Controls the effect output Low/Low Mid/High Mid/Treble: 4-band EQ that controls the effect tone Attack: Boosts/cuts high frequency amount	
AMP(87)			
Clean(36)			
Tweed Chap	The Tweed Chap is an amp simulator based on the sound characteristics of the legendary Fender® Tweed Champ* amp (5F1 version), an awesome little "practice amp" with huge tone. Crank it up you get the sweet "boxy" sound which made it popular in studios.	Volume: Controls the effect output and gain amount Output: Controls the effect output	Mono I/O

*The manufacturers and product names mentioned above are trademarks or registered trademarks of their respective owners. The trademarks were used merely to identify the sound character of the products.

Effect List

Effect Models List

FX Title	Description	Parameters & Ranges	Signal Processing
Tweed Lux	The Tweed Lux is an amp simulator based on the sound characteristics of the legendary Fender® Tweed Deluxe* amp (5E3 version, BRIGHT channel). Featuring rich, singing clean and juicy, luscious overdrive, the mysterious DELUXE amp with the TWEED cover can be found everywhere from studios to bedrooms.	Volume: Controls the effect output and gain amount Tone: Controls the effect tone Output: Controls the effect output	Mono I/O
Tweed Prince	The Tweed Prince is an amp simulator based on one of the legendary studio combo amps: Fender® Tweed Princeton Amp* (5F2-A version), another "huge tone in a small box" masterpiece which remains popular among players, builders and collectors. A Tone knob makes it more versatile.	Volume: Controls the effect output and gain amount Presence: Controls the effect headroom Output: Controls the effect output Bass/Middle/Treble: 3-band EQ that controls the effect tone	
Baseman Norm	This model is an amp simulator based on the sound characteristics of the legendary Fender® Bassman®* amp (5F6-A version, Normal channel), the American legend with a twangy top and fat bottom end. Originally designed for bass, it soon became popular among guitar players.	Volume: Controls the effect output and gain amount Output: Controls the effect output Bass/Middle/Treble: 3-band EQ that controls the effect tone	
Black Twin	The original clean sound. The Black Twin is based on the legendary Fender® '65 Twin Reverb®* amp. It provides a super clean, crystal-like sound with scooped mids, popularly known as the "Blackface Sound".	Volume: Controls the effect output and gain amount Output: Controls the effect output Bass/Middle/Treble: 3-band EQ that controls the effect tone Bright: Switches extra brightness on/off	
Black Deluxe	The Black Deluxe is an amp simulator based on the legendary Fender® Blackface Deluxe Reverb®* amp (Normal CH), providing you a more scooped "blackface" sound with chime-y highs. Plus, it's easier to crank up too!	Volume: Controls the effect output and gain amount Output: Controls the effect output Bass/Treble: 2-band EQ that controls the effect tone	
Black Deluxe+	The Black Deluxe+ is an amp simulator based on the Fender® Blackface Deluxe Reverb®* amp (Vibrato CH – the most popular channel among musicians), providing you a more scooped "blackface" sound with chime-y highs. Plus, it's easier to crank up too!	Volume: Controls the effect output and gain amount Output: Controls the effect output Bass/Treble: 2-band EQ that controls the effect tone	
Black Prince	The Black Prince is an amp simulator based on the Fender® Blackface Princeton®* amp (AA964 version). Push it to the verge of breakup you'll find the fantastic tone beloved by lots of musicians.	Volume: Controls the effect output and gain amount Output: Controls the effect output Bass/Treble: 2-band EQ that controls the effect tone	
Black Super	The Black Super is an amp simulator based on the Fender® Blackface Super Reverb®* amp (AB763 version), a huge sounding amp delivering you the lovely "blackface" chimes with enhanced treble and bass.	Volume: Controls the effect output and gain amount Output: Controls the effect output Bass/Middle/Treble: 3-band EQ that controls the effect tone Bright: Switches extra brightness on/off	

*The manufacturers and product names mentioned above are trademarks or registered trademarks of their respective owners. The trademarks were used merely to identify the sound character of the products.

Effect List

Effect Models List

FX Title	Description	Parameters & Ranges	Signal Processing
Black Vibra	The Black Vibra is an amp simulator based on the Fender® Blackface Vibroverb®* amp (AA763 version), which contributed a lot on SRV's iconic colossal tone. Plug in a classic ST-type guitar and you'll feel your Texas blood flooding!	Volume: Controls the effect output and gain amount Output: Controls the effect output Bass/Treble: 2-band EQ that controls the effect tone Bright: Switches extra brightness on/off	Mono I/O
Brown King Clean	The Brown King Clean is an amp simulator based on the Fender® Brownface Vibro-King®* amp (FAT switch off), one of Gary Clark Jr.'s favorite. It gives you a beautiful shimmering clean when turned down, and a serious touch-sensitive dirt when cranked up.	Volume: Controls the effect output and gain amount Output: Controls the effect output Bass/Middle/Treble: 3-band EQ that controls the effect tone	
Brown Vibra	The Brown Vibra is an amp simulator based on the Fender® Brownface Vibrolux®* Amp (6G11 version), giving you a warmer, slightly dirtier Fender®* tone. It became a rock legend after Mark Knopfler used it to record the famous song: Sultans of Swing.	Volume: Controls the effect output and gain amount Output: Controls the effect output Bass/Treble: 2-band EQ that controls the effect tone	
Brown Concert	The Brown Concert is an amp simulator based on the Fender® Brownface Concert®* Amp (6G12 version, Vibrato input), one of the crown jewels of vintage amps. The sound is pure, shimmering with lots of headroom. Of course you can also push it to the edge to get a mild, brown-ish overdrive.	Volume: Controls the effect output and gain amount Presence: Controls the effect headroom Output: Controls the effect output Bass/Treble: 2-band EQ that controls the effect tone	
Brown Super	The Brown Super is an amp simulator based on the Fender® Brownface Super-Amp* (6G4 version), one of the first twin-speaker "professional" amp, delivering a touch sensitive, sweet Brownface-era tone.		
Silver Twin	The Silver Twin is based on a 1970's Fender® Silverface Twin Reverb®* amp (AC568 circuit, Vibrato input), giving you a different sculpting of the classic "Fender®* Tone" – a crystal-like sound with scooped mids and great headroom.	Volume: Controls the effect output and gain amount Output: Controls the effect output Bass/Middle/Treble: 3-band EQ that controls the effect tone	
Silver Master	The Silver Master is based on the legendary Fender® Silverface Bandmaster®* amp (early AB763 version), which was treated as the "holy grail of Fender®* tone". Not much tweaking is needed - Just plug in, turn up the volume and feel the magic.	Volume: Controls the effect output and gain amount Output: Controls the effect output Bass/Treble: 2-band EQ that controls the effect tone Bright: Switches extra brightness on/off	
Superb Dual Clean	SUPERB retro tone. The Superb Dual Clean is based on the famous Supro® Dual-Tone 1624T* combo (CH 1). It produces the sweet 60s "stairway" scene replica, from bell-like cleans to gritty blues.	Volume: Controls the effect output and gain amount Output: Controls the master output Tone: Controls the effect tone	

*The manufacturers and product names mentioned above are trademarks or registered trademarks of their respective owners. The trademarks were used merely to identify the sound character of the products.

Effect List

Effect Models List

FX Title	Description	Parameters & Ranges	Signal Processing
Voxy 15 TB	This model is an amp simulator based on the sound characteristics of a vintage VOX®* AC15* combo (with Top Boost), the little brother of the legendary VOX® AC30*, giving you the same British Invasion sound.	Volume: Controls the effect output and gain amount Tone cut: Counterclockwise controls the effect tone Master: Controls the effect output Bass/Treble: 2-band EQ that controls the effect tone	Mono I/O
Voxy 30HW Norm	This model is an amp simulator based on the sound characteristics of the VOX®* AC30HW* combo (Normal channel). As the UK music scene grew out of small pubs to later cross the Pond, almost everyone was using the combo amp covered with a diamond grill cloth, the legendary VOX® AC30*. This became the British Invasion sound.	Volume: Controls the output volume (post gain) Tone cut: Counterclockwise controls the effect tone Output: Controls the effect output Bright: Switches extra brightness on/off	
Hiway 103 Norm	This model is an amp simulator based on the sound characteristics of the legendary Hiwatt® DR103* amp head (NORMAL channel), which has proved itself through decades of rock history (think Gilmour, Townshend, et al.). Set it up for pure, powerful, transparent tone or crank it to get some rich British overdrive – you decide!	Volume: Controls the effect output and gain amount Presence: Controls the effect headroom Master: Controls the effect output Bass/Middle/Treble: 3-band EQ that controls the effect tone	
Watchman	This is an amp simulator based on the Gibson® Scout* amp, a rare vintage amp with a smooth vintage clean sound.	Volume: Controls the effect output and gain amount Output: Controls the effect output	
Jazz Clean	The legendary Solid sound. Our Jazz Clean is based on the immaculate “JC clean” 2x12 solid-state jazz-amp combo. The pure transparent clean sound has ruled for more than four decades and remains incontestably reliable among pro musicians.	Volume: Controls the effect output Bright: Switches extra presence on/off Bass/Middle/Treble: 3-band EQ that controls the effect tone	
Emperor Clean	Meet the Emperor of Tone! Based on the Matchless™ Chieftain 212 combo* (clean sound), the Emperor features the rich harmonics and matchless sensitivity that made this amp a Class A legend.	Gain: Controls the gain amount (pre gain) Presence: Controls the effect headroom Master: Controls the effect output (post gain) Bass/Middle/Treble: 3-band EQ that controls the effect tone	
Match 30 Clean	Match 30 Clean is based on the unbeatable Matchless™ DC-30 combo* - one of the earliest boutique amps, which takes the legendary UK-style Class A sound to a new level.	Volume: Controls the effect output and gain amount Tone cut: Counterclockwise controls the effect tone Master: Controls the effect output (post gain) Bass/Treble: 2-band EQ that controls the effect tone	

*The manufacturers and product names mentioned above are trademarks or registered trademarks of their respective owners. The trademarks were used merely to identify the sound character of the products.

Effect List

Effect Models List

FX Title	Description	Parameters & Ranges	Signal Processing
Tang A30 Clean	Marshall SLP Jump 1 is an amp simulator based on the sound characteristics of the legendary Marshall® Super Lead 1959* amp head with “Jump” connection. No explanation necessary — The tone is as legendary as the music it helped to create. Since it has an extreme output (demanded by Pete Townshend!), we added a Output knob so you can take control.	Volume 1/2: Controls the effect output and gain amount Presence: Controls the effect headroom Output: Controls the effect output Bass/Middle/Treble: 3-band EQ that controls the effect tone	Mono I/O
Superstar Clean	The Superstar Clean is based on the clean channel of the famous Mesa/Boogie® Lone Star®* combo, bringing you a punchy, shimmering twang with love and joy.	Gain: Controls the gain amount (pre gain) Presence: Controls the effect headroom Master: Controls the effect output (post gain) Bass/Middle/Treble: 3-band EQ that controls the effect tone	
Glacian Clean	Glacian Clean is based on the clean channel of the famous Bogner® Shiva* combo (20th anniversary version). Our replica reproduces the glassy hi-fi clean sound powered by a pair of KT88 power tubes. This is a super wide-open sound with immerse headroom, sensitive moods, and great low end response.	Gain: Controls the gain amount (pre gain) Presence: Controls the effect headroom Master: Controls the effect output (post gain) Bass/Treble: 2-band EQ that controls the effect tone Bright: Switches extra brightness on/off	
Dr. 38 Clean	This model is based on one of Dr. Z®*’s most enduring designs: the famous Dr. Z® Maz 38 Sr.* combo (clean sound). This amp has the kind of clean headroom that makes it a great pedal platform, yet as a standalone it is incredibly versatile, granting access to both American twang and UK Class A chime.	Gain: Controls the output volume (pre gain) Tone cut: Counterclockwise controls the effect tone Master: Controls the effect output (post gain) Bass/Middle/Treble: 3-band EQ that controls the effect tone	
Dr. 66	This model is based on a famous Dr. Z®* model: the simple-but-powerful Dr. Z® Route 66* amp. Thanks to a pair of KT66 power tubes in the power amp, this amp can bring you an adorable creamy thick sound with lots of dynamics and definition.	Volume: Controls the effect output and gain amount Output: Controls the master output Bass/Treble: 2-band EQ that controls the effect tone	
Pendragon Clean	The Pendragon Clean is based on the Normal channel of the famous Grindrod® Pendragon PG20C* combo (bright off), a masterpiece designed by tube amp guru Steve Grindrod, ex-chief designer of VOX®* & Marshall®*. Delivering you an authentic British tone that is warm and expressive, with some simple dialing you’ll get in touch with the legendary UK rock’n’roll scenes. Turn up, stand back and you’re ready to rock!	Gain: Controls the gain amount (pre gain) Volume: Controls the effect output (post gain) Bass/Middle/Treble: 3-band EQ that controls the effect tone	
Pendragon Clean+	The Pendragon Clean+ is based on the Normal channel of the famous Grindrod® Pendragon PG20C* combo (bright on), a masterpiece designed by tube amp guru Steve Grindrod, ex-chief designer of VOX®* & Marshall®*. Delivering you an authentic British tone that is warm and expressive, with some simple dialing you’ll get in touch with the legendary UK rock’n’roll scenes. Turn up, stand back and you’re ready to rock!	Gain: Controls the gain amount (pre gain) Volume: Controls the effect output (post gain) Bass/Middle/Treble: 3-band EQ that controls the effect tone	

*The manufacturers and product names mentioned above are trademarks or registered trademarks of their respective owners. The trademarks were used merely to identify the sound character of the products.

Effect List

Effect Models List

FX Title	Description	Parameters & Ranges	Signal Processing
Press Wrecker	The Press Wrecker is based on the legendary Trainwreck® Express* amp, a super-rare boutique amp created by Ken Fischer, brings you a high end Plexi-style sound that reacts extremely faithful to your fingers.	Volume: Controls the effect output and gain amount Presence: Controls the effect headroom Output: Controls the effect output Bass/Middle/Treble: 3-band EQ that controls the effect tone Bright: Switches extra brightness on/off	Mono I/O
Pool Wrecker	The Pool Wrecker is based on the legendary Trainwreck® Liverpool* amp, a super-rare boutique amp created by Ken Fischer that reacts extremely faithful to your fingers. It creates a sound that mixes Plexi-style crunch with some Class-A chimes.	Volume: Controls the effect output and gain amount Presence: Controls the effect headroom Output: Controls the effect output Bass/Middle/Treble: 3-band EQ that controls the effect tone Bright: Switches extra brightness on/off	
Hot Kitty Clean	Based on the 1st channel of the famous Bad Cat® Hot Cat 30* amp, the Hot Kitty Clean is a total Class A clean machine. The unique tone finds itself somewhere between British and USA territories with rich upper harmonics.	Gain: Controls the gain amount (pre gain) Presence: Controls the effect headroom Master: Controls the effect output (post gain)	
Soloist 100 Clean	This model is an amp simulator based on the sound characteristics of the legendary Soldano® SLO100* amp head (NORMAL channel, clean sound), which set a benchmark for modern amps. The reason you find the sound so familiar is because you've been hearing it on gold records since 1987.	Gain: Controls the gain amount (pre gain) Presence: Controls the effect headroom Master: Controls the effect output (post gain) Bass/Middle/Treble: 3-band EQ that controls the effect tone	
Dumbell ODS 1	Here comes the THE LEGEND! The Dumbell ODS 1 is based on the legendary Dumble® Overdrive Special* amp head (Overdrive section off), providing THAT tone created by lots of legendary jazz/blues/fusion musicians.	Gain: Controls the gain amount Presence: Controls the effect headroom Master: Controls the effect output (post gain) Bass/Middle/Treble: 3-band EQ that controls the effect tone Bright: Switches extra brightness on/off Fat: Switches extra mids/gain on/off Deep: Switches extra depth on/off Voice: Selects from 2 voicings: Rock/Jazz (cuts some high frequency comparing to Rock)	
Drive(28)			
Baseman Bright	This model is an amp simulator based on the sound characteristics of the legendary Fender® Bassman®* amp (5F6-A version, Bright channel), the American legend with a twangy top and fat bottom end. Originally designed for bass, it soon became popular among guitar players.	Volume: Controls the effect output and gain amount Presence: Controls the effect headroom Output: Controls the effect output Bass/Middle/Treble: 3-band EQ that controls the effect tone	Mono I/O
Brown King Drive	The Brown King Drive is an amp simulator based on the Fender® Brownface Vibro-King®* amp (FAT switch on), one of Gary Clark Jr.'s favorite. It gives you a beautiful shimmering clean when turned down, and a serious touch-sensitive dirt when cranked up.	Volume: Controls the effect output and gain amount Output: Controls the effect output Bass/Middle/Treble: 3-band EQ that controls the effect tone	

*The manufacturers and product names mentioned above are trademarks or registered trademarks of their respective owners. The trademarks were used merely to identify the sound character of the products.

Effect List

Effect Models List

FX Title	Description	Parameters & Ranges	Signal Processing
Voxy 30HW TB	This model is an amp simulator based on the sound characteristics of the VOX®* AC30HW* combo (Top Boost channel). As the UK music scene grew out of small pubs to later cross the Pond, almost everyone was using the combo amp covered with a diamond grill cloth, the legendary VOX® AC-30*. This became the British Invasion sound.	<p>Volume: Controls the effect output and gain amount</p> <p>Tone cut: Counterclockwise controls the effect tone</p> <p>Master: Controls the effect output (post gain)</p> <p>Bass/Treble: 2-band EQ that controls the effect tone</p> <p>Char: Selects from two sound characters: Cool (lower gain)/Hot (higher gain)</p>	Mono I/O
Superb Dual Drive	<p>SUPERB retro tone.</p> <p>The Superb Dual Drive is based on the famous Supro® Dual-Tone 1624T* combo (CH 1+2, means the two preamp channels are linked in parallel). It produces the sweet 60s "stairway" scene replica, from bell-like cleans to gritty blues.</p>	<p>Volume 1/2: Controls the effect output and gain amount</p> <p>Tone 1/2: Controls the effect tone</p> <p>Output: Controls the master output</p>	
Marshall Blues	This model is an amp simulator based on the sound characteristics of the legendary Marshall® 1958* combo nicknamed "18 Watter" or "Mini Bluesbreaker®**" amp, a serious blues engine with incredible smooth, fat sound and great dynamics. A must-have in your army!	<p>Volume: Controls the effect output and gain amount</p> <p>Tone: Controls the effect tone</p> <p>Output: Controls the effect output</p>	
Marshall 45	This Marshall 45 is an amp simulator based on the sound characteristics of the legendary Marshall® JTM 45* amp head (NORMAL channel). Born in 1962, it soon became popular among countless stars and quickly defined the '60s rock & blues sound.		
Marshall 45+	This Marshall 45+ is an amp simulator based on the sound characteristics of the legendary Marshall® JTM 45* amp head (HIGH TREBLE channel). Born in 1962, it soon became popular among countless stars and quickly defined the '60s rock & blues sound.	<p>Volume: Controls the effect output and gain amount</p> <p>Presence: Controls the effect headroom</p> <p>Output: Controls the effect output</p> <p>Bass/Middle/Treble: 3-band EQ that controls the effect tone</p>	
Marshall 45 Jump	This Marshall 45 Jump is an amp simulator based on the sound characteristics of the legendary Marshall® JTM 45* amp head with "Jump" connection. Born in 1962, it soon became popular among countless stars and quickly defined the '60s rock & blues sound.		

*The manufacturers and product names mentioned above are trademarks or registered trademarks of their respective owners. The trademarks were used merely to identify the sound character of the products.

Effect List

Effect Models List

FX Title	Description	Parameters & Ranges	Signal Processing
Marshall 50	This is an amp simulator based on the sound characteristics of the legendary Marshall® JMP 50* amp head (NORMAL channel). No explanation necessary — The tone is as legendary as the music it helped to create.	Volume: Controls the effect output and gain amount Presence: Controls the effect headroom Output: Controls the effect output Bass/Middle/Treble: 3-band EQ that controls the effect tone	Mono I/O
Marshall 50+	This is an amp simulator based on the sound characteristics of the legendary Marshall® JMP 50* amp head (HIGH TREBLE channel). No explanation necessary — The tone is as legendary as the music it helped to create.		
Marshall 50 Jump	This is an amp simulator based on the sound characteristics of the legendary Marshall® JMP 50* amp head with “Jump” connection. No explanation necessary — The tone is as legendary as the music it helped to create.	Volume 1/2: Controls the effect output and gain amount Presence: Controls the effect headroom Output: Controls the effect output Bass/Middle/Treble: 3-band EQ that controls the effect tone	
Marshall SLP	Marshall SLP is an amp simulator based on the sound characteristics of the legendary Marshall® Super Lead 1959* amp head (Normal channel). No explanation necessary — The tone is as legendary as the music it helped to create. Since it has an extreme output (demanded by Pete Townshend!), we added a Output knob so you can take control.	Volume: Controls the effect output and gain amount Presence: Controls the effect headroom Output: Controls the effect output Bass/Middle/Treble: 3-band EQ that controls the effect tone	
Marshall SLP+	Marshall SLP+ is an amp simulator based on the sound characteristics of the legendary Marshall® Super Lead 1959* amp head (Bright channel). No explanation necessary — The tone is as legendary as the music it helped to create. Since it has an extreme output (demanded by Pete Townshend!), we added a Output knob so you can take control.		
Marshall SLP Jump	Marshall SLP Jump 1 is an amp simulator based on the sound characteristics of the legendary Marshall® Super Lead 1959* amp head with “Jump” connection. No explanation necessary — The tone is as legendary as the music it helped to create. Since it has an extreme output (demanded by Pete Townshend!), we added a Output knob so you can take control.	Volume 1/2: Controls the effect output and gain amount Presence: Controls the effect headroom Output: Controls the effect output Bass/Middle/Treble: 3-band EQ that controls the effect tone	
Marshall 800	This model is an amp simulator based on the sound characteristics of the legendary Marshall® JCM800* amp head. Just think about the golden 1980's – a decade of heavy metal and THAT iconic, aggressive, crunchy BRITISH LEAD sound. Now the legend is back!	Gain: Controls the gain amount (pre gain) Presence: Controls the effect headroom Master: Controls the effect output (post gain) Bass/Middle/Treble: 3-band EQ that controls the effect tone	

*The manufacturers and product names mentioned above are trademarks or registered trademarks of their respective owners. The trademarks were used merely to identify the sound character of the products.

Effect List

Effect Models List

FX Title	Description	Parameters & Ranges	Signal Processing
Pendragon Drive	The Pendragon Drive is based on the Boost channel of the famous Grindrod® Pendragon PG20C* combo, a masterpiece designed by tube amp guru Steve Grindrod, ex-chief designer of VOX® & Marshall®. Delivering you an authentic British tone that is warm and expressive, with some simple dialing you'll get in touch with the legendary UK rock'n'roll scenes. Turn up, stand back and you're ready to rock!	Gain: Controls the gain amount (pre gain) Volume: Controls the effect output (post gain) Bass/Middle/Treble: 3-band EQ that controls the effect tone	Mono I/O
Messe IIC+	The California Dream. This model is based on the legendary Mesa/Boogie® Mark II C+™* amp head (LEAD channel). Now you have one of the hottest amp tones: Tight, focused rhythm riffs and the legendary "liquid lead" tone. This amp gets the aeons of sustain Metallica and Dream Theater bet their lives on.	Gain: Controls the gain amount Presence: Controls the effect headroom Master: Controls the effect output (post gain) Bass/Middle/Treble: 3-band EQ that controls the effect tone Bass/Treble Shift: Switches extra bass/treble on/off Deep: Switches extra low end on/off Bright: Switches extra brightness on/off	
Glacian Drive	Glacian Drive is based on the drive channel of the famous Bogner® Shiva* combo (20th anniversary version). Our replica reproduces the glassy hi-fi driven sound powered by a pair of KT88 power tubes. This is a super wide-open sound with immerse headroom, sensitive moods, and great low end response.	Gain: Controls the gain amount (pre gain) Presence: Controls the effect headroom Master: Controls the effect output (post gain) Bass/Middle/Treble: 3-band EQ that controls the effect tone	
Tang A30 Drive	The Tang A30 Drive is based on the famous Orange® AD30* amp head (CH 2), a 30-watt, vintage modern Class A model with Orange®'s famous "juicy" sound. Adjust the GAIN knob to get the magic: glassy boutique chime with the gain low, and roaring British chomp with the gain up.	Gain: Controls the gain amount (pre gain) Master: Controls the effect output (post gain) Bass/Middle/Treble: 3-band EQ that controls the effect tone	
Fryman B	Fryman B is based on a famous UK-style boutique amp head (BE channel). This is an incredible tone machine based on the classic hot British amps. But this amp is extremely versatile: with some knob tweaking, you'll be amazed by the super tight low ends, sweet mids and rich harmonics.	Gain: Controls the gain amount (pre gain) Presence: Controls the effect headroom Master: Controls the effect output (post gain) Bass/Middle/Treble: 3-band EQ that controls the effect tone Voice/Fat/C45: Adjusts overall tonal characters	
Boger XT Blue V	This model is based on the 2nd channel (the blue channel) of the famous Bogner® Ecstasy* head (vintage sound character), which has been a favorite for every style and genre of music since 1992.	Gain: Controls the gain amount (pre gain) Presence: Controls the effect headroom Master: Controls the effect output (post gain) Bass/Middle/Treble: 3-band EQ that controls the effect tone	
Boger XT Blue M	This model is based on the 2nd channel (the blue channel) of the famous Bogner® Ecstasy* head (modern sound character), which has been a favorite for every style and genre of music since 1992.	Bright: Controls the effect brightness Plexi Mode: Switches Plexi Mode on/off; in Plexi Mode the amp performs like a plexi-style amp	

*The manufacturers and product names mentioned above are trademarks or registered trademarks of their respective owners. The trademarks were used merely to identify the sound character of the products.

Effect List

Effect Models List

FX Title	Description	Parameters & Ranges	Signal Processing
Soloist 100 Crunch	This model is an amp simulator based on the sound characteristics of the legendary Soldano® SLO100* amp head (NORMAL channel, dirty sound), which set a benchmark for modern amps. The reason you find the sound so familiar is because you've been hearing it on gold records since 1987.	Gain: Controls the gain amount (pre gain) Presence: Controls the effect headroom Master: Controls the effect output (post gain) Bass/Middle/Treble: 3-band EQ that controls the effect tone	Mono I/O
Emperor Drive	Meet the Emperor of Tone! Based on the Matchless™ Chieftain 212 combo* (driven sound), the Emperor features the rich harmonics and matchless sensitivity that made this amp a Class A legend.	Gain: Controls the gain amount (pre gain) Presence: Controls the effect headroom Master: Controls the effect output (post gain) Bass/Middle/Treble: 3-band EQ that controls the effect tone	
Dr. 38 Drive	This model is based on one of Dr. Z®*'s most enduring designs: the famous Dr. Z® Maz 38 Sr.* combo (drive sound). This amp has the kind of clean headroom that makes it a great pedal platform, yet as a standalone it is incredibly versatile, granting access to both American twang and UK Class A chime.	Gain: Controls the output volume (pre gain) Tone cut: Counterclockwise controls the effect tone Master: Controls the effect output (post gain) Bass/Middle/Treble: 3-band EQ that controls the effect tone	
Superstar Drive	The Superstar Drive is based on the drive channel of the famous Mesa/Boogie® Lone Star®* combo, bringing you that well-balanced, smooth American-style drive with a rich combination of both vintage and modern tones.	Input: Controls the input sensitivity Gain: Controls the gain amount Presence: Controls the effect headroom Master: Controls the effect output (post gain) Bass/Middle/Treble: 3-band EQ that controls the effect tone	
Hot Kitty Drive	Based on the 2nd channel of the famous Bad Cat® Hot Cat 30* amp, the Hot Kitty Drive is a total Class A drive machine. The unique tone finds itself somewhere between British and USA territories with complex mids, tight lows and rich upper harmonics.	Gain: Controls the gain amount (pre gain) Presence: Controls the effect headroom Master: Controls the effect output (post gain) Edge: Controls the high and high-mid tone character Bass/Treble: 2-band EQ that controls the effect tone	
Dumbell ODS 2	Here comes the THE LEGEND! The Dumbell ODS 2 is based on the legendary Dumble® Overdrive Special* amp head (Overdrive section on), providing THAT tone created by lots of legendary jazz/blues/fusion musicians.	Input: Controls the input sensitivity Gain: Controls the gain amount Presence: Controls the effect headroom Master: Controls the effect output (post gain) Bass/Middle/Treble: 3-band EQ that controls the effect tone Bright: Switches extra brightness on/off Fat: Switches extra mids/gain on/off Deep: Switches extra depth on/off Voice: Selects from 2 voicings: Rock/Jazz (cuts some high frequency comparing to Rock)	

*The manufacturers and product names mentioned above are trademarks or registered trademarks of their respective owners. The trademarks were used merely to identify the sound character of the products.

Effect List

Effect Models List

FX Title	Description	Parameters & Ranges	Signal Processing
Hi Gain(17)			
Marshall 900	This model is an amp simulator based on the sound characteristics of the legendary Marshall® JCM900 (model 4100, CH B)* amp head. Released in 1990, it was designed to produce more gain, less noise and stainless Marshall® tone.	Gain: Controls the gain amount (pre gain) Presence: Controls the effect headroom Master: Controls the effect output (post gain) Bass/Middle/Treble: 3-band EQ that controls the effect tone	Mono I/O
Tang R100	The Tang R100 is based on the famous Orange® Rockverb 100™* amp head, Orange®*’s first high gain amplifier. Its unique thick voice has become eternally linked with hard rock/stoner rock.	Gain: Controls the gain amount (pre gain) Master: Controls the effect output (post gain) Bass/Middle/Treble: 3-band EQ that controls the effect tone	
Messe IV Lead	The classic Boogie Lead sound...and beyond. This model is based on the legendary Mesa/Boogie® Mark IV™* amp head (LEAD channel). This massive lead tone is one of the most beautifully voiced tones that can always be heard in a mix.	Gain: Controls the gain amount Presence: Controls the effect headroom Master: Controls the effect output (post gain) Bass/Middle/Treble: 3-band EQ that controls the effect tone Fat: Switch on to get a fatter sound Bright: Switches extra brightness on/off Voicing: Selects from two voicings: Mid Gain (a punchier sound with more mids and distortion)/Harmony (a more balanced sound)	
Soloist 100 Lead	This model is an amp simulator based on the sound characteristics of the legendary Soldano® SLO100* amp head (OVERDRIVE channel), which set a benchmark for modern amps. The reason you find the sound so familiar is because you’ve been hearing it on gold records since 1987.	Gain: Controls the gain amount (pre gain) Presence: Controls the effect headroom Master: Controls the effect output (post gain) Bass/Middle/Treble: 3-band EQ that controls the effect tone	
Eddie 51	The Eddie 51 is based on a heavy rock legend: the Peavey® 5150®* (LEAD channel). The original is famous for its raw tone and relentless power. Our Eddie 51 gives you the “brown metal” sound heard on legendary heavy metal records.	Gain: Controls the gain amount (pre gain) Presence: Controls the effect headroom Master: Controls the effect output (post gain) Bass/Middle/Treble: 3-band EQ that controls the effect tone	
Fryman HB	Fryman HB is based on a famous UK-style boutique amp head (HBE channel). This is an incredible tone machine based on the classic hot British amps. But this amp is extremely versatile: with some knob tweaking, you’ll be amazed by the super tight low ends, sweet mids and rich harmonics.	Gain: Controls the gain amount (pre gain) Presence: Controls the effect headroom Master: Controls the effect output (post gain) Bass/Middle/Treble: 3-band EQ that controls the effect tone Voice/Fat/C45: Adjusts overall tonal characters	
Engle Saga 1	The Engle Saga 1 is based on the famous ENGL® Savage 120 E610* amp head (Channel 4, contour off). This replica reproduces the iconic modern German rock sound featuring fast response, enhanced headroom and punchy dynamics.	Input: Controls the input sensitivity Gain: Controls the gain amount Presence: Controls the effect headroom Master: Controls the effect output (post gain) Bass/Middle/Treble: 3-band EQ that controls the effect tone	
Engle Saga 2	The Engle Saga 2 is based on the famous ENGL® Savage 120 E610* amp head (Channel 4, contour on). This replica reproduces the iconic modern German rock sound featuring fast response, enhanced headroom and punchy dynamics.	Voice: Selects overall sound character from Rough to Smooth Depth Boost: Switches extra resonance on/off	

*The manufacturers and product names mentioned above are trademarks or registered trademarks of their respective owners. The trademarks were used merely to identify the sound character of the products.

Effect List

Effect Models List

FX Title	Description	Parameters & Ranges	Signal Processing
Powerengle Lead	The Powerengle Lead is based on the lead channel (Channel 4) of the famous ENGL® Powerball II E645/2* amp head. Truly ideal for modern rock and metal, it features a tight low end, a huge amount of gain, sharp clarity, and great dynamics.		
Dizzle VH B	The Dizzle VH B is based on the 3rd channel of the famous Diezel® VH4* amp head. Born in 1994, the VH4 set an incredibly high benchmark for boutique multi-channel amps, quickly making it a stage and studio standard. "B" stands for "blue panel" version.		
Dizzle VH S	The Dizzle VH S is based on the 3rd channel of the famous Diezel® VH4* amp head. Born in 1994, the VH4 set an incredibly high benchmark for boutique multi-channel amps, quickly making it a stage and studio standard. "S" stands for "silver panel" version.		
Rector Dual V	The Rector Dual V is based on an enduring rock' n' roll icon: the legendary Mesa/Boogie® Dual Rectifier® amp head (CH3, vintage). Music industry genres and scenes have come and gone since its first release in early 1990's, but this amp's monolithic heavy sound continues to be the standard for modern heavy rock.	Gain: Controls the gain amount (pre gain) Presence: Controls the effect headroom Master: Controls the effect output (post gain)	
Rector Dual M	The Rector Dual M is based on an enduring rock' n' roll icon: the legendary Mesa/Boogie® Dual Rectifier® amp head (CH3, modern). Music industry genres and scenes have come and gone since its first release in early 1990's, but this amp's monolithic heavy sound continues to be the standard for modern heavy rock.	Bass/Middle/Treble: 3-band EQ that controls the effect tone	
Dizzle VH+ B	The Dizzle VH+ B is based on the 4th channel of the famous Diezel® VH4* amp head. Born in 1994, the VH4 set an incredibly high benchmark for boutique multi-channel amps, quickly making it a stage and studio standard. "B" stands for "blue panel" version.		
Dizzle VH+ S	The Dizzle VH+ S is based on the 4th channel of the famous Diezel® VH4* amp head. Born in 1994, the VH4 set an incredibly high benchmark for boutique multi-channel amps, quickly making it a stage and studio standard. "S" stands for "silver panel" version.		
Boger XT Red V	This model is based on the 3rd channel (the red channel) of the famous Bogner® Ecstasy* head (vintage sound character), which has been a favorite for every style and genre of music since 1992.	Gain: Controls the gain amount (pre gain) Presence: Controls the effect headroom Master: Controls the effect output (post gain) Bass/Middle/Treble: 3-band EQ that controls the effect tone Bright: Controls the effect brightness Plexi Mode: Switches Plexi Mode on/off; in Plexi Mode the amp performs like a plexi-style amp	Mono I/O

*The manufacturers and product names mentioned above are trademarks or registered trademarks of their respective owners. The trademarks were used merely to identify the sound character of the products.

Effect List

Effect Models List

FX Title	Description	Parameters & Ranges	Signal Processing
Boger XT Red M	This model is based on the 3rd channel (the red channel) of the famous Bogner ® Ecstasy* head (modern sound character), which has been a favorite for every style and genre of music since 1992.	Gain: Controls the gain amount (pre gain) Presence: Controls the effect headroom Master: Controls the effect output (post gain) Bass/Middle/Treble: 3-band EQ that controls the effect tone Bright: Controls the effect brightness Plexi Mode: Switches Plexi Mode on/off; in Plexi Mode the amp performs like a plexi-style amp	Mono I/O
Bass(5)			
Ampage Classic	The original rock bass sound. The Ampage Classic is based on the legendary Ampeg® SVT* bass amp head. Born in 1969, the rich sounding all-tube monster basically defined the bass sound of rock and roll from then on. We modified the Frequency switch with a modern Ampeg®* design for more tonal flexibility.	Gain: Controls the gain amount Frequency: Selects the center frequency of Midrange control: 220Hz/450Hz /800Hz/1.6kHz/3kHz Master: Controls the effect output Bass/Midrange/Treble: 3-band EQ that controls the effect tone	
Ampage Flip	The legendary Flip Top is here! Our Ampage Flip is based on the legendary Ampeg® B-15* bass amp head. Originally designed by Jess Oliver, the easy-to-use amp produces incredible round, full-figured tone for which many have deemed it the holy grail of bass amps. Now it's finally within reach!		
Voxy Bass	The British Invasion bass sound is now available. Voxy Bass is an amp simulator based on the sound characteristics of the legendary VOX® AC-100* amp head, the amp that McCartney was using in 1965. The operation is simple: just treble, bass, and volume controls. Using a violin bass with this amp will totally get you THAT vibe.	Volume: Controls the output volume (post gain) Bass/Treble: 2-band EQ that controls the effect tone	Mono I/O
Tang Bass	The Tang Bass is based on the famous Orange® AD200B* bass amp head, a straight forward amp with huge power. The four 6550 power tubes ensures a ground shaking tone with lots of dynamics.	Volume: Controls the effect output and gain amount Master: Controls the effect output (post gain) Bass/Middle/Treble: 3-band EQ that controls the effect tone	
Messe Bass 400	This model is based on the famous Mesa/Boogie® Bass 400* bass amp head, one of Mesa/Boogie®'s rare bass products. As one of the most classic most classic and sought-after tube bass amps in history, the amp will never let you down.	Volume: Controls the gain amount (pre gain) Master: Controls the effect output (post gain) Bass/Middle/Treble: 3-band EQ that controls the effect tone	

*The manufacturers and product names mentioned above are trademarks or registered trademarks of their respective owners. The trademarks were used merely to identify the sound character of the products.

Effect List

Effect Models List

FX Title	Description	Parameters & Ranges	Signal Processing
Power Amp (1)			
Power Amp	This model is a tube power amp simulator with various tonal controls.	Tube Type: Selects from different power tube types: -6L6: Commonly found in many US style amps -EL34: Commonly found in many UK style amps -EL84: Commonly found in some classic Class-A amps -6V6: Commonly found in some legendary low powered US combo amps -Kt66: Commonly found in early UK Plexi-style amps and some boutique amps -KT88: Commonly found in boutique/modern hi gain amps and bass amps -6550: Commonly found in bass amps Depth: Controls the effect depth Presence: Controls the effect headroom Sag: Turn up to reduce power supply voltage to create a compression feel B+ Response: Controls the B+ voltage for a looser (turn up)/faster (turn down) picking response Negative FB: Controls the negative feedback amount; turn up to get a quieter tone Output: Controls the effect output	Mono I/O
PRE AMP(88)			
Clean(36)			
Tweed Chap	The Tweed Chap is a preamp simulator based on the sound characteristics of the legendary Fender® Tweed Champ* amp (5F1 version), an awesome little "practice amp" with huge tone. Crank it up you get the sweet "boxy" sound which made it popular in studios.	Volume: Controls the effect output and gain amount Output: Controls the effect output	Mono I/O
Tweed Lux	The Tweed Lux is a preamp simulator based on the sound characteristics of the legendary Fender® Tweed Deluxe* amp (5E3 version, BRIGHT channel). Featuring rich, singing clean and juicy, luscious overdrive, the mysterious DELUXE amp with the TWEED cover can be found everywhere from studios to bedrooms.	Volume: Controls the effect output and gain amount Tone: Controls the effect tone Output: Controls the effect output	
Tweed Prince	The Tweed Prince is a preamp simulator based on one of the legendary studio combo amps: Fender® Tweed Princeton Amp* (5F2-A version), another "huge tone in a small box" masterpiece which remains popular among players, builders and collectors. A Tone knob makes it more versatile.	Volume: Controls the effect output and gain amount Output: Controls the effect output Bass/Middle/Treble: 3-band EQ that controls the effect tone	
Baseman Norm	This model is a preamp simulator based on the sound characteristics of the legendary Fender® Bassman®* amp (5F6-A version, Normal channel), the American legend with a twangy top and fat bottom end. Originally designed for bass, it soon became popular among guitar players.	Volume: Controls the effect output and gain amount Output: Controls the effect output Bass/Middle/Treble: 3-band EQ that controls the effect tone	

*The manufacturers and product names mentioned above are trademarks or registered trademarks of their respective owners. The trademarks were used merely to identify the sound character of the products.

Effect List

Effect Models List

FX Title	Description	Parameters & Ranges	Signal Processing
Black Twin	The Black Twin is a preamp simulator based on the legendary Fender® '65 Twin Reverb®* amp. It provides a super clean, crystal-like sound with scooped mids, popularly known as the "Blackface Sound".	Volume: Controls the effect output and gain amount Output: Controls the effect output Bass/Middle/Treble: 3-band EQ that controls the effect tone Bright: Switches extra brightness on/off	Mono I/O
Black Deluxe	The Black Deluxe is a preamp simulator based on the legendary Fender® Blackface Deluxe Reverb®* amp (Normal CH), providing you a more scooped "blackface" sound with chime-y highs. Plus, it's easier to crank up too!	Volume: Controls the effect output and gain amount Output: Controls the effect output Bass/Treble: 2-band EQ that controls the effect tone	
Black Deluxe+	The Black Deluxe+ is a preamp simulator based on the Fender® Blackface Deluxe Reverb®* amp (Vibrato CH – the most popular channel among musicians), providing you a more scooped "blackface" sound with chime-y highs. Plus, it's easier to crank up too!	Volume: Controls the effect output and gain amount Output: Controls the effect output Bass/Treble: 2-band EQ that controls the effect tone	
Black Prince	The Black Prince is a preamp simulator based on the Fender® Blackface Princeton®* amp (AA964 version). Push it to the verge of breakup you'll find the fantastic tone beloved by lots of musicians.	Volume: Controls the effect output and gain amount Output: Controls the effect output Bass/Treble: 2-band EQ that controls the effect tone	
Black Super	The Black Super is a preamp simulator based on the Fender® Blackface Super Reverb®* amp (AB763 version), a huge sounding amp delivering you the lovely "blackface" chimes with enhanced treble and bass.	Volume: Controls the effect output and gain amount Output: Controls the effect output Bass/Middle/Treble: 3-band EQ that controls the effect tone Bright: Switches extra brightness on/off	
Black Vibra	The Black Vibra is a preamp simulator based on the Fender® Blackface Vibroverb®* amp (AA763 version), which contributed a lot on SRV's iconic colossal tone. Plug in a classic ST-type guitar and you'll feel your Texas blood flooding!	Volume: Controls the effect output and gain amount Output: Controls the effect output Bass/Treble: 2-band EQ that controls the effect tone Bright: Switches extra brightness on/off	
Brown King Clean	The Brown King Clean is a preamp simulator based on the Fender® Brownface Vibro-King®* amp (FAT switch off), one of Gary Clark Jr.'s favorite. It gives you a beautiful shimmering clean when turned down, and a serious touch-sensitive dirt when cranked up.	Volume: Controls the effect output and gain amount Output: Controls the effect output Bass/Middle/Treble: 3-band EQ that controls the effect tone	
Brown Vibra	The Brown Vibra is a preamp simulator based on the Fender® Brownface Vibrolux®* Amp (6G11 version), giving you a warmer, slightly dirtier Fender®* tone. It became a rock legend after Mark Knopfler used it to record the famous song: Sultans of Swing.	Volume: Controls the effect output and gain amount Output: Controls the effect output Bass/Treble: 2-band EQ that controls the effect tone	

*The manufacturers and product names mentioned above are trademarks or registered trademarks of their respective owners. The trademarks were used merely to identify the sound character of the products.

Effect List

Effect Models List

FX Title	Description	Parameters & Ranges	Signal Processing
Brown Concert	The Brown Concert is a preamp simulator based on the Fender® Brownface Concert®* Amp (6G12 version, Vibrato input), one of the crown jewels of vintage amps. The sound is pure, shimmering with lots of headroom. Of course you can also push it to the edge to get a mild, brownish overdrive.	Volume: Controls the effect output and gain amount Presence: Controls the effect headroom Output: Controls the effect output Bass/Treble: 2-band EQ that controls the effect tone	Mono I/O
Brown Super	The Brown Super is a preamp simulator based on the Fender® Brownface Super-Amp* (6G4 version), one of the first twin-speaker "professional" amp, delivering a touch sensitive, sweet Brownface-era tone.	Volume: Controls the effect output and gain amount Output: Controls the effect output Bass/Treble: 2-band EQ that controls the effect tone	
Silver Twin	The Silver Twin is a preamp simulator based on a 1970's Fender® Silverface Twin Reverb®* amp (AC568 circuit, Vibrato input), giving you a different sculpting of the classic "Fender®* Tone" – a crystal-like sound with scooped mids and great headroom.	Volume: Controls the effect output and gain amount Output: Controls the effect output Bass/Middle/Treble: 3-band EQ that controls the effect tone	
Silver Master	The Silver Master is a preamp simulator based on the legendary Fender® Silverface Bandmaster®* amp (early AB763 version), which was treated as the "holy grail of Fender®* tone". Not much tweaking is needed - Just plug in, turn up the volume and feel the magic.	Volume: Controls the effect output and gain amount Output: Controls the effect output Bass/Treble: 2-band EQ that controls the effect tone Bright: Switches extra brightness on/off	
Superb Dual Clean	SUPERB retro tone. The Superb Dual Clean is a preamp simulator based on the famous Supro® Dual-Tone 1624T* combo (CH 1). It produces the sweet 60s "stairway" scene replica, from bell-like cleans to gritty blues.	Volume: Controls the effect output and gain amount Output: Controls the master output Tone: Controls the effect tone	
Voxy 15 TB	This model is a preamp simulator based on the sound characteristics of a vintage VOX®* AC15* combo (with Top Boost), the little brother of the legendary VOX® AC30*, giving you the same British Invasion sound.	Volume: Controls the effect output and gain amount Master: Controls the effect output Bass/Treble: 2-band EQ that controls the effect tone	
Voxy 30HW Norm	This model is a preamp simulator based on the sound characteristics of the VOX®* AC30HW* combo (Normal channel). As the UK music scene grew out of small pubs to later cross the Pond, almost everyone was using the combo amp covered with a diamond grill cloth, the legendary VOX® AC30*. This became the British Invasion sound.	Volume: Controls the output volume Output: Controls the effect output Bright: Switches extra brightness on/off	

*The manufacturers and product names mentioned above are trademarks or registered trademarks of their respective owners. The trademarks were used merely to identify the sound character of the products.

Effect List

Effect Models List

FX Title	Description	Parameters & Ranges	Signal Processing
Hiway 103 Norm	This model is a preamp simulator based on the sound characteristics of the legendary Hiwatt® DR103* amp head (NORMAL channel), which has proved itself through decades of rock history (think Gilmour, Townshend, et al.). Set it up for pure, powerful, transparent tone or crank it to get some rich British overdrive – you decide!	Volume: Controls the effect output and gain amount Master: Controls the effect output Bass/Middle/Treble: 3-band EQ that controls the effect tone	Mono I/O
Watchman	This is a preamp simulator based on the Gibson® Scout* amp, a rare vintage amp with a smooth vintage clean sound.	Volume: Controls the effect output and gain amount Output: Controls the effect output	
Jazz Clean	The Jazz Clean is a preamp simulator based on the immaculate “JC clean” 2x12 solid-state jazz-amp combo. The pure transparent clean sound has ruled for more than four decades and remains incontestably reliable among pro musicians.	Volume: Controls the effect output Bright: Switches extra presence on/off Bass/Middle/Treble: 3-band EQ that controls the effect tone	
Emperor Clean	Meet the Emperor of Tone! This is a preamp simulator based on the Matchless™ Chieftain 212 combo* (clean sound), gives you the rich harmonics and matchless sensitivity that made this amp a Class A legend.	Gain: Controls the gain amount Master: Controls the effect output Bass/Middle/Treble: 3-band EQ that controls the effect tone	
Match 30 Clean	Match 30 Clean is a preamp simulator based on the unbeatable Matchless™ DC-30 combo* - one of the earliest boutique amps, which takes the legendary UK-style Class A sound to a new level.	Volume: Controls the effect output and gain amount Master: Controls the effect output Bass/Treble: 2-band EQ that controls the effect tone	
Tang A30 Clean	The Tang A30 Clean is a preamp simulator based on the famous Orange® AD30* amp head (CH 1), a 30-watt, vintage modern Class A model with Orange®*’s famous “juicy” sound. Adjust the GAIN knob to get the magic: glassy boutique chime with the gain low, and roaring British chomp with the gain up.	Gain: Controls the gain amount Master: Controls the effect output Bass/Middle/Treble: 3-band EQ that controls the effect tone	
Superstar Clean	The Superstar Clean is a preamp simulator based on the clean channel of the famous Mesa/Boogie® Lone Star®* combo, bringing you a punchy, shimmering twang with love and joy.	Gain: Controls the gain amount Presence: Controls the effect headroom Master: Controls the effect output Bass/Middle/Treble: 3-band EQ that controls the effect tone	
Glacian Clean	Glacian Clean is based on the clean channel of the preamp section of the famous Bogner® Shiva* combo (20th anniversary version), providing a super wide-open sound with immerse headroom, sensitive moods, and great low end response.	Gain: Controls the gain amount Master: Controls the effect output Bass/Treble: 2-band EQ that controls the effect tone Bright: Switches extra brightness on/off	

*The manufacturers and product names mentioned above are trademarks or registered trademarks of their respective owners. The trademarks were used merely to identify the sound character of the products.

Effect List

Effect Models List

FX Title	Description	Parameters & Ranges	Signal Processing
Dr. 38 Clean	This model is a preamp simulator based on one of Dr. Z®*’s most enduring designs: the famous Dr. Z® Maz 38 Sr.* combo (clean sound). This amp has the kind of clean headroom that makes it a great pedal platform, yet as a standalone it is incredibly versatile, granting access to both American twang and UK Class A chime.	Gain: Controls the output volume (pre gain) Master: Controls the effect output (post gain) Bass/Middle/Treble: 3-band EQ that controls the effect tone	Mono I/O
Dr. 66	This model is a preamp simulator based on a famous Dr. Z®* model: the simple-but-powerful Dr. Z® Route 66* amp. Thanks to a pair of KT66 power tubes in the power amp, this amp can bring you an adorable creamy thick sound with lots of dynamics and definition.	Volume: Controls the effect output and gain amount Output: Controls the master output Bass/Treble: 2-band EQ that controls the effect tone	
Pendragon Clean	The Pendragon Clean is a preamp simulator based on the Normal channel of the famous Grindrod® Pendragon PG20C* combo (bright off), a masterpiece designed by tube amp guru Steve Grindrod, ex-chief designer of VOX®* & Marshall®*. Delivering you an authentic British tone that is warm and expressive, with some simple dialing you’ll get in touch with the legendary UK rock’n’roll scenes. Turn up, stand back and you’re ready to rock!	Gain: Controls the gain amount (pre gain) Volume: Controls the effect output (post gain) Bass/Middle/Treble: 3-band EQ that controls the effect tone	
Pendragon Clean+	The Pendragon Clean+ is a preamp simulator based on the Normal channel of the famous Grindrod® Pendragon PG20C* combo (bright on), a masterpiece designed by tube amp guru Steve Grindrod, ex-chief designer of VOX®* & Marshall®*. Delivering you an authentic British tone that is warm and expressive, with some simple dialing you’ll get in touch with the legendary UK rock’n’roll scenes. Turn up, stand back and you’re ready to rock!		
Press Wrecker	The Press Wrecker is a preamp simulator based on the legendary Trainwreck® Express* amp, a super-rare boutique amp created by Ken Fischer, brings you a high end Plexi-style sound that reacts extremely faithful to your fingers.	Volume: Controls the effect output and gain amount Output: Controls the effect output Bass/Middle/Treble: 3-band EQ that controls the effect tone Bright: Switches extra brightness on/off	
Pool Wrecker	The Pool Wrecker is a preamp simulator based on the legendary Trainwreck® Liverpool* amp, a super-rare boutique amp created by Ken Fischer that reacts extremely faithful to your fingers. It creates a sound that mixes Plexi-style crunch with some Class-A chimes.		
Hot Kitty Clean	Based on the preamp section of 1st channel of the famous Bad Cat® Hot Cat 30* amp, the Hot Kitty Clean is a total clean machine. The unique tone finds itself somewhere between British and USA territories with rich upper harmonics.	Gain: Controls the gain amount Master: Controls the effect output	

*The manufacturers and product names mentioned above are trademarks or registered trademarks of their respective owners. The trademarks were used merely to identify the sound character of the products.

Effect List

Effect Models List

FX Title	Description	Parameters & Ranges	Signal Processing
Soloist 100 Clean	This model is a preamp simulator based on the sound characteristics of the legendary Soldano® SLO100* amp head (NORMAL channel, clean sound), which set a benchmark for modern amps. The reason you find the sound so familiar is because you've been hearing it on gold records since 1987.	Gain: Controls the gain amount Master: Controls the effect output Bass/Middle/Treble: 3-band EQ that controls the effect tone	Mono I/O
Dumbell ODS 1	Here comes the THE LEGEND! The Dumbell ODS 1 is a preamp simulator based on the legendary Dumble® Overdrive Special* amp head (Overdrive section off), providing THAT tone created by lots of legendary jazz/blues/fusion musicians.	Gain: Controls the gain amount Master: Controls the effect output Bass/Middle/Treble: 3-band EQ that controls the effect tone Bright: Switches extra brightness on/off Fat: Switches extra mids/gain on/off Deep: Switches extra depth on/off Voice: Selects from 2 voicings: Rock/Jazz (cuts some high frequency comparing to Rock)	
Drive(28)			
Baseman Bright	This model is a preamp simulator based on the sound characteristics of the legendary Fender® Bassman®* amp (5F6-A version, Bright channel), the American legend with a twangy top and fat bottom end. Originally designed for bass, it soon became popular among guitar players.	Volume: Controls the effect output and gain amount Output: Controls the effect output Bass/Middle/Treble: 3-band EQ that controls the effect tone	Mono I/O
Brown King Drive	The Brown King Drive is a preamp simulator based on the Fender® Brownface Vibro-King®* amp (FAT switch on), one of Gary Clark Jr.'s favorite. It gives you a beautiful shimmering clean when turned down, and a serious touch-sensitive dirt when cranked up.	Volume: Controls the effect output and gain amount Output: Controls the effect output Bass/Middle/Treble: 3-band EQ that controls the effect tone	
Voxy 30HW TB	This model is a preamp simulator based on the sound characteristics of the VOX®* AC30HW* combo (Top Boost channel). As the UK music scene grew out of small pubs to later cross the Pond, almost everyone was using the combo amp covered with a diamond grill cloth, the legendary VOX® AC-30*. This became the British Invasion sound.	Volume: Controls the effect output and gain amount Master: Controls the effect output Bass/Treble: 2-band EQ that controls the effect tone Char: Selects from two sound characters: Cool (lower gain)/Hot (higher gain)	
Superb Dual Drive	SUPERB retro tone. The Superb Dual Drive is a preamp simulator based on the famous Supro® Dual-Tone 1624T* combo (CH 1+2, means the two preamp channels are linked in parallel). It produces the sweet 60s "stairway" scene replica, from bell-like cleans to gritty blues.	Volume 1/2: Controls the effect output and gain amount Tone 1/2: Controls the effect tone Output: Controls the master output	

*The manufacturers and product names mentioned above are trademarks or registered trademarks of their respective owners. The trademarks were used merely to identify the sound character of the products.

Effect List

Effect Models List

FX Title	Description	Parameters & Ranges	Signal Processing
Marshall Blues	This model is a preamp simulator based on the sound characteristics of the legendary Marshall® 1958* combo nicknamed “18 Watter” or “Mini Bluesbreaker” amp, a serious blues engine with incredible smooth, fat sound and great dynamics. A must-have in your armory!	Volume: Controls the effect output and gain amount Tone: Controls the effect tone Output: Controls the effect output	Mono I/O
Marshall 45	This Marshall 45 is a preamp simulator based on the sound characteristics of the legendary Marshall® JTM 45* amp head (NORMAL channel). Born in 1962, it soon became popular among countless stars and quickly defined the '60s rock & blues sound.	Volume: Controls the effect output and gain amount Output: Controls the effect output Bass/Middle/Treble: 3-band EQ that controls the effect tone	
Marshall 45+	This Marshall 45+ is a preamp simulator based on the sound characteristics of the legendary Marshall® JTM 45* amp head (HIGH TREBLE channel). Born in 1962, it soon became popular among countless stars and quickly defined the '60s rock & blues sound.		
Marshall 45 Jump	This Marshall 45 Jump is a preamp simulator based on the sound characteristics of the legendary Marshall® JTM 45* amp head with “Jump” connection. Born in 1962, it soon became popular among countless stars and quickly defined the '60s rock & blues sound.	Volume 1/2: Controls the effect output and gain amount Output: Controls the effect output Bass/Middle/Treble: 3-band EQ that controls the effect tone	
Marshall 50	This is a preamp simulator based on the sound characteristics of the legendary Marshall® JMP 50* amp head (NORMAL channel). No explanation necessary — The tone is as legendary as the music it helped to create.	Volume: Controls the effect output and gain amount Output: Controls the effect output Bass/Middle/Treble: 3-band EQ that controls the effect tone	
Marshall 50+	This is a preamp simulator based on the sound characteristics of the legendary Marshall® JMP 50* amp head (HIGH TREBLE channel). No explanation necessary — The tone is as legendary as the music it helped to create.		
Marshall 50 Jump	This is a preamp simulator based on the sound characteristics of the legendary Marshall® JMP 50* amp head with “Jump” connection. No explanation necessary — The tone is as legendary as the music it helped to create.	Volume 1/2: Controls the effect output and gain amount Output: Controls the effect output Bass/Middle/Treble: 3-band EQ that controls the effect tone	
Marshall SLP	Marshall SLP is a preamp simulator based on the sound characteristics of the legendary Marshall® Super Lead 1959* amp head (Normal channel). No explanation necessary — The tone is as legendary as the music it helped to create. Since it has an extreme output (demanded by Pete Townshend!), we added a Output knob so you can take control.	Volume: Controls the effect output and gain amount Output: Controls the effect output Bass/Middle/Treble: 3-band EQ that controls the effect tone	

*The manufacturers and product names mentioned above are trademarks or registered trademarks of their respective owners. The trademarks were used merely to identify the sound character of the products.

Effect List

Effect Models List

FX Title	Description	Parameters & Ranges	Signal Processing
Marshall SLP+	Marshall SLP+ is a preamp simulator based on the sound characteristics of the legendary Marshall® Super Lead 1959* amp head (Bright channel). No explanation necessary — The tone is as legendary as the music it helped to create. Since it has an extreme output (demanded by Pete Townshend!), we added a Output knob so you can take control.	Volume: Controls the effect output and gain amount Output: Controls the effect output Bass/Middle/Treble: 3-band EQ that controls the effect tone	Mono I/O
Marshall SLP Jump	Marshall SLP Jump 1 is a preamp simulator based on the sound characteristics of the legendary Marshall® Super Lead 1959* amp head with “Jump” connection. No explanation necessary — The tone is as legendary as the music it helped to create. Since it has an extreme output (demanded by Pete Townshend!), we added a Output knob so you can take control.		
Marshall 800	This model is a preamp simulator based on the sound characteristics of the legendary Marshall® JCM800* amp head. Just think about the golden 1980’s – a decade of heavy metal and THAT iconic, aggressive, crunchy BRITISH LEAD sound. Now the legend is back!	Gain: Controls the gain amount Master: Controls the effect output Bass/Middle/Treble: 3-band EQ that controls the effect tone	
Pendragon Drive	The Pendragon Drive is a preamp simulator based on the Boost channel of the famous Grindrod® Pendragon PG20C* combo, a masterpiece designed by tube amp guru Steve Grindrod, ex-chief designer of VOX®* & Marshall®*. Delivering you an authentic British tone that is warm and expressive, with some simple dialing you’ll get in touch with the legendary UK rock’n’roll scenes. Turn up, stand back and you’re ready to rock!	Gain: Controls the gain amount (pre gain) Volume: Controls the effect output (post gain) Bass/Middle/Treble: 3-band EQ that controls the effect tone	
Messe IIC+	The California Dream. This model is a preamp simulator based on the legendary Mesa/Boogie® Mark II C+™* amp head (LEAD channel). Now you have one of the hottest amp tones: Tight, focused rhythm riffs and the legendary “liquid lead” tone. This amp gets the aeons of sustain Metallica and Dream Theater bet their lives on.	Gain: Controls the gain amount Master: Controls the effect output Bass/Middle/Treble: 3-band EQ that controls the effect tone Bass/Treble Shift: Switches extra bass/treble on/off Deep: Switches extra low end on/off Bright: Switches extra brightness on/off	
Glacian Drive	Glacian Drive is based on the drive channel of the preamp section of the famous Bogner® Shiva* combo (20th anniversary version). providing a super wide-open sound with immerse headroom, sensitive moods, and great low end response.	Gain: Controls the gain amount Master: Controls the effect output Bass/Middle/Treble: 3-band EQ that controls the effect tone	
Tang A30 Drive	The Tang A30 Drive is a preamp simulator based on the famous Orange® AD30* amp head (CH 2), a 30-watt, vintage modern Class A model with Orange®*’s famous “juicy” sound. Adjust the GAIN knob to get the magic: glassy boutique chime with the gain low, and roaring British chomp with the gain up.	Gain: Controls the gain amount Master: Controls the effect output Bass/Middle/Treble: 3-band EQ that controls the effect tone	

*The manufacturers and product names mentioned above are trademarks or registered trademarks of their respective owners. The trademarks were used merely to identify the sound character of the products.

Effect List

Effect Models List

FX Title	Description	Parameters & Ranges	Signal Processing
Fryman B	Fryman B is a preamp simulator based on a famous UK-style boutique amp head (BE channel). This is an incredible tone machine based on the classic hot British amps. But this amp is extremely versatile: with some knob tweaking, you'll be amazed by the super tight low ends, sweet mids and rich harmonics.	Gain: Controls the gain amount Master: Controls the effect output Bass/Middle/Treble: 3-band EQ that controls the effect tone Voice/Fat/C45: Adjusts overall tonal characters	Mono I/O
Boger XT Blue V	This model is a preamp simulator based on the 2nd channel (the blue channel) of the famous Bogner® Ecstasy* head (vintage sound character), which has been a favorite for every style and genre of music since 1992.	Gain: Controls the gain amount Master: Controls the effect output Bass/Middle/Treble: 3-band EQ that controls the effect tone	
Boger XT Blue M	This model is a preamp simulator based on the 2nd channel (the blue channel) of the famous Bogner® Ecstasy* head (modern sound character), which has been a favorite for every style and genre of music since 1992.	Bright: Controls the effect brightness Plexi Mode: Switches Plexi Mode on/off; in Plexi Mode the amp performs like a plexi-style amp	
Soloist 100 Crunch	This model is a preamp simulator based on the sound characteristics of the legendary Soldano® SLO100* amp head (NORMAL channel, dirty sound), which set a benchmark for modern amps. The reason you find the sound so familiar is because you've been hearing it on gold records since 1987.		
Emperor Drive	Meet the Emperor of Tone! This is a preamp simulator based on the Matchless™ Chieftain 212 combo* (driven sound), gives you the rich harmonics and matchless sensitivity that made this amp a Class A legend.	Gain: Controls the gain amount Master: Controls the effect output Bass/Middle/Treble: 3-band EQ that controls the effect tone	
Dr. 38 Drive	This model is a preamp simulator based on one of Dr. Z®*s most enduring designs: the famous Dr. Z® Maz 38 Sr.* combo (drive sound). This amp has the kind of clean headroom that makes it a great pedal platform, yet as a standalone it is incredibly versatile, granting access to both American twang and UK Class A chime.		
Superstar Drive	The Superstar Drive is a preamp simulator based on the drive channel of the famous Mesa/Boogie® Lone Star®* combo, bringing you that well-balanced, smooth American-style drive with a rich combination of both vintage and modern tones.	Input: Controls the input sensitivity Gain: Controls the gain amount Presence: Controls the effect headroom Master: Controls the effect output Bass/Middle/Treble: 3-band EQ that controls the effect tone	
Hot Kitty Drive	Based on the preamp section of 2nd channel of the famous Bad Cat® Hot Cat 30* amp, the Hot Kitty Drive is a total drive machine. The unique tone finds itself somewhere between British and USA territories with complex mids, tight lows and rich upper harmonics.	Gain: Controls the gain amount Master: Controls the effect output Edge: Controls the high and high-mid tone character Bass/Treble: 2-band EQ that controls the effect tone	

*The manufacturers and product names mentioned above are trademarks or registered trademarks of their respective owners. The trademarks were used merely to identify the sound character of the products.

Effect List

Effect Models List

FX Title	Description	Parameters & Ranges	Signal Processing
Dumbell ODS 2	Here comes the THE LEGEND! The Dumbell ODS 2 is a preamp simulator based on the legendary Dumble® Overdrive Special* amp head (Overdrive section on), providing THAT tone created by lots of legendary jazz/blues/fusion musicians.	Input: Controls the input sensitivity Gain: Controls the gain amount Master: Controls the effect output Bass/Middle/Treble: 3-band EQ that controls the effect tone Bright: Switches extra brightness on/off Fat: Switches extra mids/gain on/off Deep: Switches extra depth on/off Voice: Selects from 2 voicings: Rock/Jazz (cuts some high frequency comparing to Rock)	Mono I/O
Hi gain(17)			
Marshall 900	This model is a preamp simulator based on the sound characteristics of the legendary Marshall® JCM900 (model 4100, CH B)* amp head. Released in 1990, it was designed to produce more gain, less noise and stainless Marshall® tone.	Gain: Controls the gain amount Master: Controls the effect output Bass/Middle/Treble: 3-band EQ that controls the effect tone	Mono I/O
Tang R100	The Tang R100 is a preamp simulator based on the famous Orange® Rockerverb 100™* amp head, Orange®*s first high gain amplifier. Its unique thick voice has become eternally linked with hard rock/stoner rock.	Gain: Controls the gain amount Master: Controls the effect output Bass/Middle/Treble: 3-band EQ that controls the effect tone	
Messe IV Lead	The classic Boogie Lead sound...and beyond. This model is a preamp simulator based on the legendary Mesa/Boogie® Mark IV™* amp head (LEAD channel). This massive lead tone is one of the most beautifully voiced tones that can always be heard in a mix.	Gain: Controls the gain amount Master: Controls the effect output Bass/Middle/Treble: 3-band EQ that controls the effect tone Fat: Switch on to get a fatter sound Bright: Switches extra brightness on/off Voicing: Selects from two voicings: Mid Gain (a punchier sound with more mids and distortion)/Harmony (a more balanced sound)	
Soloist 100 Lead	This model is a preamp simulator based on the sound characteristics of the legendary Soldano® SLO100* amp head (OVERDRIVE channel), which set a benchmark for modern amps. The reason you find the sound so familiar is because you've been hearing it on gold records since 1987.	Gain: Controls the gain amount Master: Controls the effect output Bass/Middle/Treble: 3-band EQ that controls the effect tone	
Eddie 51	The Eddie 51 is a preamp simulator based on a heavy rock legend: the Peavey® 5150®* (LEAD channel). The original is famous for its raw tone and relentless power. Our Eddie 51 gives you the "brown metal" sound heard on legendary heavy metal records.	Gain: Controls the gain amount Master: Controls the effect output Bass/Middle/Treble: 3-band EQ that controls the effect tone	
Fryman HB	Fryman HB is a preamp simulator based on a famous UK-style boutique amp head (HBE channel). This is an incredible tone machine based on the classic hot British amps. But this amp is extremely versatile: with some knob tweaking, you'll be amazed by the super tight low ends, sweet mids and rich harmonics.	Gain: Controls the gain amount Master: Controls the effect output Bass/Middle/Treble: 3-band EQ that controls the effect tone Voice/Fat/C45: Adjusts overall tonal characters	

*The manufacturers and product names mentioned above are trademarks or registered trademarks of their respective owners. The trademarks were used merely to identify the sound character of the products.

Effect List

Effect Models List

FX Title	Description	Parameters & Ranges	Signal Processing
Engle Saga 1	The Engle Saga 1 is a preamp simulator based on the famous ENGL® Savage 120 E610* amp head (Channel 4, contour off). This replica reproduces the iconic modern German rock sound featuring fast response, enhanced headroom and punchy dynamics.	Input: Controls the input sensitivity Gain: Controls the gain amount Master: Controls the effect output Bass/Middle/Treble: 3-band EQ that controls the effect tone	Mono I/O
Engle Saga 2	The Engle Saga 2 is a preamp simulator based on the famous ENGL® Savage 120 E610* amp head (Channel 4, contour on). This replica reproduces the iconic modern German rock sound featuring fast response, enhanced headroom and punchy dynamics.	Voice: Selects overall sound character from Rough to Smooth Depth Boost: Switches extra resonance on/off	
Powerengle Lead	The Powerengle Lead is a preamp simulator based on the lead channel (Channel 4) of the famous ENGL® Powerball II E645/2* amp head. Truly ideal for modern rock and metal, it features a tight low end, a huge amount of gain, sharp clarity, and great dynamics.		
Dizzle VH B	The Dizzle VH B is a preamp simulator based on the 3rd channel of the famous Diezel® VH4* amp head. Born in 1994, the VH4 set an incredibly high benchmark for boutique multi-channel amps, quickly making it a stage and studio standard. "B" stands for "blue panel" version.	Gain: Controls the gain amount (pre gain) Master: Controls the effect output (post gain) Bass/Middle/Treble: 3-band EQ that controls the effect tone	
Dizzle VH S	The Dizzle VH S is a preamp simulator based on the 3rd channel of the famous Diezel® VH4* amp head. Born in 1994, the VH4 set an incredibly high benchmark for boutique multi-channel amps, quickly making it a stage and studio standard. "S" stands for "silver panel" version.		
Rector Dual V	The Rector Dual V is a preamp simulator based on an enduring rock' n' roll icon: the legendary Mesa/Boogie® Dual Rectifier® amp head (CH3, vintage). Music industry genres and scenes have come and gone since its first release in early 1990's, but this amp's monolithic heavy sound continues to be the standard for modern heavy rock.	Gain: Controls the gain amount (pre gain) Presence: Controls the effect headroom Master: Controls the effect output (post gain) Bass/Middle/Treble: 3-band EQ that controls the effect tone	
Rector Dual M	The Rector Dual M is a preamp simulator based on an enduring rock' n' roll icon: the legendary Mesa/Boogie® Dual Rectifier® amp head (CH3, modern). Music industry genres and scenes have come and gone since its first release in early 1990's, but this amp's monolithic heavy sound continues to be the standard for modern heavy rock.		

*The manufacturers and product names mentioned above are trademarks or registered trademarks of their respective owners. The trademarks were used merely to identify the sound character of the products.

Effect List

Effect Models List

FX Title	Description	Parameters & Ranges	Signal Processing
Dizzle VH+ B	The Dizzle VH+ B is a preamp simulator based on the 4th channel of the famous Diezel® VH4* amp head. Born in 1994, the VH4 set an incredibly high benchmark for boutique multi-channel amps, quickly making it a stage and studio standard. "B" stands for "blue panel" version.	Gain: Controls the gain amount (pre gain) Master: Controls the effect output (post gain) Bass/Middle/Treble: 3-band EQ that controls the effect tone	Mono I/O
Dizzle VH+ S	The Dizzle VH+ S is a preamp simulator based on the 4th channel of the famous Diezel® VH4* amp head. Born in 1994, the VH4 set an incredibly high benchmark for boutique multi-channel amps, quickly making it a stage and studio standard. "S" stands for "silver panel" version.		
Bogner XT Red V	This model is a preamp simulator based on the 3rd channel (the red channel) of the famous Bogner® Ecstasy* head (vintage sound character), which has been a favorite for every style and genre of music since 1992.	Gain: Controls the gain amount Master: Controls the effect output Bass/Middle/Treble: 3-band EQ that controls the effect tone	
Bogner XT Red M	This model is a preamp simulator based on the 3rd channel (the red channel) of the famous Bogner® Ecstasy* head (modern sound character), which has been a favorite for every style and genre of music since 1992.	Bright: Controls the effect brightness Plexi Mode: Switches Plexi Mode on/off; in Plexi Mode the amp performs like a plexi-style amp	
Ampage Classic	The original rock bass sound. The Ampage Classic is a preamp simulator based on the legendary Ampeg® SVT* bass amp head. Born in 1969, the rich sounding all-tube monster basically defined the bass sound of rock and roll from then on. We modified the Frequency switch with a modern Ampeg®* design for more tonal flexibility.	Gain: Controls the gain amount Frequency: Selects the center frequency of Midrange control: 220Hz/450Hz /800Hz/1.6kHz/3kHz Master: Controls the effect output Bass/Midrange/Treble: 3-band EQ that controls the effect tone	
Ampage Flip	The legendary Flip Top is here! Our Ampage Flip is a preamp simulator based on the legendary Ampeg® B-15* bass amp head. Originally designed by Jess Oliver, the easy-to-use amp produces incredible round, full-figured tone for which many have deemed it the holy grail of bass amps. Now it's finally within reach!	Volume: Controls the effect output Bass/Treble: 2-band EQ that controls the effect tone	
Alchemy Pre	Alchemy Pre is based on the legendary Alembic™ F-2B* rack-mount bass preamp. It recreates the rich, magical tube sound that made the F-2B* a classic. This treatment is not just for bass— it's awesome on guitars (think Gilmour) and more!	Volume: Controls the effect output Bright: Switches extra brightness on/off Bass/Middle/Treble: 3-band EQ that controls the effect tone	
Voxy Bass	Voxy Bass is a preamp simulator based on the sound characteristics of the legendary VOX® AC-100* amp head, the amp that McCartney was using in 1965. The operation is simple: just treble, bass, and volume controls. Using a violin bass with this amp will totally get you THAT vibe.	Volume: Controls the output volume Bass/Treble: 2-band EQ that controls the effect tone	
Tang Bass	The Tang R100 is a preamp simulator based on the famous Orange® AD200B* bass amp head, a straight forward amp delivering a ground shaking tone with lots of dynamics.	Gain: Controls the gain amount Master: Controls the effect output Bass/Middle/Treble: 3-band EQ that controls the effect tone	

*The manufacturers and product names mentioned above are trademarks or registered trademarks of their respective owners. The trademarks were used merely to identify the sound character of the products.

Effect List

Effect Models List

FX Title	Description	Parameters & Ranges	Signal Processing
Messe Bass 400	This model is a preamp simulator based on the famous Mesa/Boogie® Bass 400* bass amp head, one of Mesa/Boogie®'s rare bass products. As one of the most classic most classic and sought-after tube bass amps in history, the amp will never let you down.	Volume: Controls the gain amount Master: Controls the effect output Bass/Middle/Treble: 3-band EQ that controls the effect tone	Mono I/O
Acoustic(1)			
Acoustic Pre	This model is an acoustic preamp based on the famous AER® Colourizer 2*, which makes dull sounds come alive by enriching your acoustic sound with full dynamics and harmonics.	Volume: Controls the effect gain amount Volume: Controls the effect output Tone Mix: Controls the tone control balance; set to 0 to disable tone control Tone Depth: Controls the tone brightness EQ Freq: Controls the EQ center frequency EQ Q: Controls the EQ bandwidth EQ Gain: Controls the EQ boost/cut amount; set to 50 to keep neutral EQ Freq: Selects from two EQ ranges: f1 (90Hz to 1.6kHz)/f2 (680Hz to 11kHz) Enhancer: Controls tone enhancement amount; turn to minimum (off) to disable enhancer	Mono I/O
FX Title	Description	Signal Processing	
CAB(68)			
Guitar Cab			
<p>Mic Type: Selects from different microphone simulations*:</p> <ul style="list-style-type: none"> -Dyn 57: Based on Shure® Sm57 -Dyn 421: Based on Sennheiser® Md421 -Rib 121: Based on Royal® R121 -Rib 160: Based on Beyerdynamic® M160 -Con 87: Based on Neumann® U87 -Con 414: Based on AKG® C414 -Mix 1: Shure® SM57+Sennheiser® MD421 combo -Mix 2: Shure® SM57+ Royal® R121 combo -Mix 3: Sennheiser® MD421+Royal® R121 combo -Mix 4: Multi-mic combo <p>Volume: Controls the output volume Low Cut/High Cut: Cuts the low/high frequency Position: Selects from 6 microphone positioning variations (-Center/Near Center/Cap Edge/Cone/Near Edge/Edge)</p>			
Guitar Cab S(30)			
Voxy 1x10 A	This model is a cabinet simulator based on the sound characteristics of a VOX®* 1x10" combo cabinet.	Mono I/O	
Voxy 1x10 B	This model is a cabinet simulator based on the sound characteristics of a vintage VOX®* 1x10" combo cabinet.		
Voxy GRN 1x10	This model is a cabinet simulator based on the sound characteristics of a VOX®* 1x10" combo cabinet with a 10-inch Celestion® Greenback* speaker.		
Voxy Custom 1x10	This model is a cabinet simulator based on the sound characteristics of a custom VOX® AC4* combo cabinet.		
TWD 1x10	This model is a cabinet simulator based on the sound characteristics of a vintage Fender® Tweed* 1x10" combo cabinet.		

*The manufacturers and product names mentioned above are trademarks or registered trademarks of their respective owners. The trademarks were used merely to identify the sound character of the products.

Effect List

Effect Models List

FX Title	Description	Signal Processing
TWD VN 1x10	This model is a cabinet simulator based on the sound characteristics of a custom Fender® Tweed* 1x10" combo cabinet with a 10-inch Celestion® G10 Vintage* speaker.	Mono I/O
Golden 1x10	This model is a cabinet simulator based on the sound characteristics of a vintage Gibson®* 1x10" combo cabinet.	
UK Custom 1x12	This model is a cabinet simulator based on the sound characteristics of a custom Marshall®* 1x12" cabinet.	
TWD 1x12	This model is a cabinet simulator based on the sound characteristics of a vintage Fender® Tweed* 1x12" combo cabinet.	
TWD Dlx 1x12	This model is a cabinet simulator based on the sound characteristics of a Fender® Tweed Deluxe* 1x12" combo cabinet with a 12-inch Jensen® P12R* speaker.	
Black 1x12	This model is a cabinet simulator based on the sound characteristics of a Fender®* 1x12" combo cabinet with a 12-inch Celestion® Vintage 30®* speaker.	
Black Dlx 1x12 A	This model is a cabinet simulator based on the sound characteristics of a vintage Fender® Deluxe Reverb* 1x12" combo cabinet.	
Black Dlx 1x12 B	This model is a cabinet simulator based on the sound characteristics of a Fender® Deluxe Reverb* 1x12" combo cabinet with a Jensen® C12R* speaker.	
Black Dlx 1x12 C	This model is a cabinet simulator based on the sound characteristics of a Fender® Deluxe Reverb* 1x12" combo cabinet with a custom speaker.	
Golden 1x12	This model is a cabinet simulator based on the sound characteristics of a vintage Gibson®* 1x12" combo cabinet.	
Boger 2x12 A	This model is a cabinet simulator based on the sound characteristics of a Bogner®* 2x12" cabinet with two 12-inch Celestion® Greenback* speakers.	
Boger 2x12 B	This model is a cabinet simulator based on the sound characteristics of a Bogner®* 2x12" cabinet with two 12-inch Celestion® Vintage 30®* speakers.	
Glacian 2x12 A	This model is a cabinet simulator based on the sound characteristics of a Bogner® Shiva* 2x12" cabinet.	
Glacian 2x12 B	This model is a cabinet simulator based on the sound characteristics of a Bogner® Shiva* 2x12" cabinet with Celestion® Alnico Gold* speakers.	
Tang 2x12 A	This model is a cabinet simulator based on the sound characteristics of a custom Orange® PPC212* 2x12" cabinet.	
Tang 2x12 B	This model is a cabinet simulator based on the sound characteristics of an Orange® PPC212* 2x12" cabinet.	
Messe 2x12	This model is a cabinet simulator based on the sound characteristics of a custom Mesa/Boogie®* 2x12" cabinet.	
Rector 2x12 A	This model is a cabinet simulator based on the sound characteristics of a Mesa/Boogie® Rectifier®* 2x12" cabinet with two 12-inch Celestion® Vintage 30®* speakers.	
Rector 2x12 B	This model is a cabinet simulator based on the sound characteristics of a Mesa/Boogie® Rectifier®* 2x12" cabinet with two 12-inch Celestion® G12H-30®* speakers.	
Rector 2x12 C	This model is a cabinet simulator based on the sound characteristics of a modified Mesa/Boogie® Rectifier®* 2x12" cabinet with two 12-inch Celestion® G12M®* speakers.	
Voxy 2x12 A	This model is a cabinet simulator based on the sound characteristics of a VOX® AC30* combo cabinet with two 12-inch Celestion® Alnico Blue* speakers.	
Voxy 2x12 B	This model is a cabinet simulator based on the sound characteristics of a VOX® AC30* combo cabinet with two 12-inch Celestion® G12H-30* speakers.	
Voxy Cream 2x12	This model is a cabinet simulator based on the sound characteristics of a VOX® AC30* combo cabinet with two 12-inch Celestion® Alnico Cream* speakers.	
Voxy Green 2x12	This model is a cabinet simulator based on the sound characteristics of a VOX® AC30* combo cabinet with two 12-inch Celestion® Greenback* speakers.	

*The manufacturers and product names mentioned above are trademarks or registered trademarks of their respective owners. The trademarks were used merely to identify the sound character of the products.

Effect List

Effect Models List

FX Title	Description	Signal Processing
Voxy Gold 2x12	This model is a cabinet simulator based on the sound characteristics of a VOX® AC30* combo cabinet with two 12-inch Celestion® Alnico Gold* speakers.	Mono I/O
Guitar Cab L(30)		
Boger 4x10 A	This model is a cabinet simulator based on the sound characteristics of a Bogner®* 4x10" cabinet.	Mono I/O
Boger 4x10 B	This model is a cabinet simulator based on the sound characteristics of a modified Bogner®* 4x10" cabinet.	
Super 4x10 A	This model is a cabinet simulator based on the sound characteristics of a Fender® Super Reverb* 4x10" cabinet with four 10-inch Jensen®* speakers.	
Super 4x10 B	This model is a cabinet simulator based on the sound characteristics of a vintage Fender® Super Reverb* 4x10" cabinet with Fender®* speakers.	
Boger 4x12 A	This model is a cabinet simulator based on the sound characteristics of a Bogner®* 4x12" cabinet with four 12-inch Celestion® G12T-75* speakers.	
Boger 4x12 B	This model is a cabinet simulator based on the sound characteristics of a Bogner®* 4x12" cabinet with four 12-inch Celestion® Vintage 30®* speakers.	
Dizzle 4x12 A	This model is a cabinet simulator based on the sound characteristics of a Diezel®* 4x12" cabinet with four 12-inch Celestion® G12K-100* speakers.	
Dizzle 4x12 B	This model is a cabinet simulator based on the sound characteristics of a Diezel®* 4x12" cabinet with four 12-inch Celestion® Vintage 30®* speakers.	
Eddie 4x12 A	This model is a cabinet simulator based on the sound characteristics of a EVH® 5150III®* 4x12" cabinet.	
Eddie 4x12 B	This model is a cabinet simulator based on the sound characteristics of a modified EVH® 5150III®* 4x12" cabinet.	
Engle 4x12 A	This model is a cabinet simulator based on the sound characteristics of a ENGL®* 4x12" cabinet with four 12-inch Celestion® Vintage 30®* speakers.	
Engle 4x12 B	This model is a cabinet simulator based on the sound characteristics of a ENGL®* 4x12" cabinet with four 12-inch Celestion® Greenback* speakers.	
Fryman 4x12 A	This model is a cabinet simulator based on the sound characteristics of a boutique UK-style brand 4x12" cabinet with four 12-inch Celestion® Greenback* speakers.	
Fryman 4x12 B	This model is a cabinet simulator based on the sound characteristics of a boutique UK-style brand 4x12" cabinet with four 12-inch Celestion® Vintage 30®* speakers.	
UK Cream 4x12	This model is a cabinet simulator based on the sound characteristics of a Marshall®* 4x12" cabinet with four 12-inch Celestion® G12H-30* speakers.	
UK Check 4x12	This model is a cabinet simulator based on the sound characteristics of a vintage Marshall®* "Checkboard" 4x12" cabinet.	
UK Green 4x12	This model is a cabinet simulator based on the sound characteristics of a vintage Marshall®* 4x12" cabinet with four 12-inch Celestion® Greenback* speakers.	
UK Custom 4x12	This model is a cabinet simulator based on the sound characteristics of a custom vintage Marshall®* 4x12" cabinet with four 12-inch Electro-Voice® EVM12L* speakers.	
UK Vintage 4x12	This model is a cabinet simulator based on the sound characteristics of a vintage Marshall®* 4x12" cabinet with four 12-inch Marshall®* speakers.	
UK Black 4x12	This model is a cabinet simulator based on the sound characteristics of a vintage Marshall®* 4x12" cabinet with four 12-inch Celestion® Blackback* speakers.	
UK 82 4x12	This model is a cabinet simulator based on the sound characteristics of a Marshall® 1982B* 4x12" cabinet.	
Tang 4x12 A	This model is a cabinet simulator based on the sound characteristics of an Orange® PPC412* 4x12" cabinet.	

*The manufacturers and product names mentioned above are trademarks or registered trademarks of their respective owners. The trademarks were used merely to identify the sound character of the products.

Effect List

Effect Models List

FX Title	Description	Signal Processing
Tang 4x12 B	This model is a cabinet simulator based on the sound characteristics of a vintage Orange®* 4x12" cabinet.	Mono I/O
Tang 4x12 C	This model is a cabinet simulator based on the sound characteristics of a custom vintage Orange®* 4x12" cabinet.	
Messe 4x12 A	This model is a cabinet simulator based on the sound characteristics of a Mesa/Boogie®* 4x12" cabinet with "Vintage Black Shadow" speakers.	
Messe 4x12 B	This model is a cabinet simulator based on the sound characteristics of a Mesa/Boogie®* 4x12" cabinet with four 12-inch Celestion® Vintage 30®* speakers.	
Rector 4x12 A	This model is a cabinet simulator based on the sound characteristics of a custom Mesa/Boogie® Rectifier* 4x12" cabinet with four 12-inch Eminence®* speakers.	
Rector 4x12 B	This model is a cabinet simulator based on the sound characteristics of a Mesa/Boogie® Rectifier* "Traditional" 4x12" cabinet.	
Rector 4x12 C	This model is a cabinet simulator based on the sound characteristics of a Mesa/Boogie® Rectifier* "Oversized" 4x12" cabinet.	
Rector 4x12 D	This model is a cabinet simulator based on the sound characteristics of a custom Mesa/Boogie® Rectifier* 4x12" cabinet with four 12-inch Celestion® G12M-65®* speakers.	
Bass Cab(8)		
<p>Mic Type: Selects from different microphone simulations*: -Dyn 421: Based on Sennheiser® Md421 -Rib 160: Based on Beyerdynamic® M160 -Con 87: Based on Neumann® U87 -Mix: Multi-mic combo Volume: Controls the output volume EQ: Selects from 2 different EQ variations: -I: A rounder tone -II: A fatter, aggressive tone Smooth: Turn on to smooth out both low/high ends Low Cut/High Cut: Cuts the low/high frequency</p>		
Ampage 2x10 A	This model is a cabinet simulator based on the sound characteristics of a vintage Ampeg®* 2x10" cabinet.	Mono I/O
Ampage 2x10 B	This model is a cabinet simulator based on the sound characteristics of an Ampeg® SVT-210AV* 2x10" cabinet.	
Ampage 2x10 C	This model is a cabinet simulator based on the sound characteristics of a modified vintage Ampeg®* 2x10" cabinet.	
Ampage 2x10 D	This model is a cabinet simulator based on the sound characteristics of a Ampeg® SVT-210AV* 2x10" cabinet with Ampeg®* speakers.	
Ampage 4x10 A	This model is a cabinet simulator based on the sound characteristics of a vintage Ampeg®* 4x10" cabinet.	
Ampage 4x10 B	This model is a cabinet simulator based on the sound characteristics of an Ampeg® SVT-410HLF* 4x10" cabinet.	
Ampage 4x10 C	This model is a cabinet simulator based on the sound characteristics of a modified Ampeg® SVT-410HLF* 4x10" cabinet.	
Ampage 4x10 D	This model is a cabinet simulator based on the sound characteristics of a modified vintage Ampeg®* 4x10" cabinet.	

*The manufacturers and product names mentioned above are trademarks or registered trademarks of their respective owners. The trademarks were used merely to identify the sound character of the products.

Effect List

Effect Models List

FX Title	Description	Signal Processing
IR(80)		
Volume: Controls the output volume Low Cut/High Cut: Cuts the low/high frequency Resolution: Switches IR resolution from low (1024 points) to high (2048 points)		
Acoustic IR(10)		
Dreadnought 1	This model is an acoustic simulator based on the sound characteristics of a Dreadnought steel-string acoustic guitar.	Mono I/O
Dreadnought 2	This model is an acoustic simulator based on the sound characteristics of a Dreadnought steel-string acoustic guitar.	
Orchestral	This model is an acoustic simulator based on the sound characteristics of a OM type steel-string acoustic guitar.	
Jumbo	This model is an acoustic simulator based on the sound characteristics of a jumbo style steel-string acoustic guitar.	
Hum Bird	This model is an acoustic simulator based on the sound characteristics of an iconic "H-Bird" steel-string acoustic guitar.	
Auditorium	This model is an acoustic simulator based on the sound characteristics of a GA type steel-string acoustic guitar.	
Classical	This model is an acoustic simulator based on the sound characteristics of a classical guitar.	
Mandolin	This model is an acoustic simulator based on the sound characteristics of a mandolin.	
Fretless Bass	This model is an acoustic simulator based on the sound characteristics of a fretless bass.	
Double Bass	This model is an acoustic simulator based on the sound characteristics of a double bass.	
Celestion® IR(20)		
Blue 1x12 Close	This IR is based on the sound characteristics of a 1x12 close back cabinet with one 12-inch Celestion® Alnico Blue* speaker, captured by a set of carefully balanced studio microphones.	Mono I/O
Blue 1x12 Open	This IR is based on the sound characteristics of a 1x12 open back cabinet with one 12-inch Celestion® Alnico Blue* speaker, captured by a set of carefully balanced studio microphones.	
G12H-C 1x12 Close	This IR is based on the sound characteristics of a 1x12 close back cabinet with one 12-inch Celestion® G12H Creamback* speaker, captured by a set of carefully balanced studio microphones.	
G12H-C 1x12 Open	This IR is based on the sound characteristics of a 1x12 open back cabinet with one 12-inch Celestion® G12H Creamback* speaker, captured by a set of carefully balanced studio microphones.	
Blue 2x12 Close	This IR is based on the sound characteristics of a 2x12 close back cabinet with two 12-inch Celestion® Alnico Blue* speakers, captured by a set of carefully balanced studio microphones.	
Blue 2x12 Open	This IR is based on the sound characteristics of a 2x12 open back cabinet with two 12-inch Celestion® Alnico Blue* speakers, captured by a set of carefully balanced studio microphones.	
G12H-A 2x12 Close	This IR is based on the sound characteristics of a 2x12 close back cabinet with two 12-inch Celestion® G12H Anniversary* speakers, captured by a set of carefully balanced studio microphones.	
G12H-A 2x12 Open	This IR is based on the sound characteristics of a 2x12 open back cabinet with two 12-inch Celestion® G12H Anniversary* speakers, captured by a set of carefully balanced studio microphones.	
G12H-C 2x12 Close	This IR is based on the sound characteristics of a 2x12 close back cabinet with two 12-inch Celestion® G12H Creamback* speakers, captured by a set of carefully balanced studio microphones.	
G12H-C 2x12 Open	This IR is based on the sound characteristics of a 2x12 open back cabinet with two 12-inch Celestion® G12H Creamback* speakers, captured by a set of carefully balanced studio microphones.	

*The manufacturers and product names mentioned above are trademarks or registered trademarks of their respective owners. The trademarks were used merely to identify the sound character of the products.

Effect List

Effect Models List

FX Title	Description		Signal Processing
G12M-C 2x12 Close	This IR is based on the sound characteristics of a 2x12 close back cabinet with two 12-inch Celestion® G12M Creamback* speakers, captured by a set of carefully balanced studio microphones.		Mono I/O
G12M-C 2x12 Open	This IR is based on the sound characteristics of a 2x12 open back cabinet with two 12-inch Celestion® G12M Creamback* speakers, captured by a set of carefully balanced studio microphones.		
Green 2x12	This IR is based on the sound characteristics of a 2x12 close back cabinet with two 12-inch Celestion® G12M Greenback* speakers, captured by a set of carefully balanced studio microphones.		
V30 2x12	This IR is based on the sound characteristics of a 2x12 close back cabinet with two 12-inch Celestion® Vintage 30®* speakers, captured by a set of carefully balanced studio microphones.		
G12-65 4x12	This IR is based on the sound characteristics of a 4x12 close back cabinet with four 12-inch Celestion® G12-65* speakers, captured by a set of carefully balanced studio microphones.		
G12H-A 4x12	This IR is based on the sound characteristics of a 4x12 close back cabinet with four 12-inch Celestion® G12H Anniversary* speakers, captured by a set of carefully balanced studio microphones.		
G12H-C 4x12	This IR is based on the sound characteristics of a 4x12 close back cabinet with four 12-inch Celestion® G12H Creamback* speakers, captured by a set of carefully balanced studio microphones.		
G12M-C 4x12	This IR is based on the sound characteristics of a 4x12 close back cabinet with four 12-inch Celestion® G12M Creamback* speakers, captured by a set of carefully balanced studio microphones.		
Green 4x12	This IR is based on the sound characteristics of a 4x12 close back cabinet with four 12-inch Celestion® G12M Greenback* speakers, captured by a set of carefully balanced studio microphones.		
V30 4x12	This IR is based on the sound characteristics of a 4x12 close back cabinet with four 12-inch Celestion® Vintage 30®* speakers, captured by a set of carefully balanced studio microphones.		
User IR 1~50	This is for loading your own IR file by clicking "Import IR file" button. The IR file should be a 24-bit 44.1kHz mono WAV file.		
FX Title	Description	Parameters & Ranges	Signal Processing
EQ(10)			
Guitar EQ 1	This is an equalizer made for guitar. You can use this 5-band EQ to control your sound, eliminate unwanted feedback, and expand your tone.	Band 1: 125Hz; Band 2: 400Hz ; Band 3: 800Hz Band 4: 1.6kHz; Band 5: 4kHz Use the five bands above to control the EQ level. Volume: Controls the output level	Stereo I/O
Guitar EQ 2	This is an equalizer made for guitar. You can use this 5-band EQ to control your sound, eliminate unwanted feedback, and expand your tone.	Band 1: 100Hz; Band 2: 500Hz ; Band 3: 1kHz Band 4: 3kHz; Band 5: 6kHz Use the five bands above to control the EQ level. Volume: Controls the output level	
Bass EQ 1	This is an equalizer made for bass. You can use this 5-band EQ to control your sound, eliminate unwanted feedback, and expand your tone.	Band 1: 33Hz; Band 2: 150Hz ; Band 3: 600Hz Band 4: 2kHz; Band 5: 8kHz Use the five bands above to control the EQ level. Volume: Controls the output level	
Bass EQ 2	This is an equalizer made for bass. You can use this 5-band EQ to control your sound, eliminate unwanted feedback, and expand your tone.	Band 1: 50Hz; Band 2: 120Hz ; Band 3: 400Hz Band 4: 800Hz; Band 5: 4.5kHz Use the five bands above to control the EQ level. Volume: Controls the output level	
V-EQ	Our V-EQ is an equalizer based on the legendary Mesa/Boogie®* 5-band graphic EQ module found on Mesa/Boogie® Mark™* Series amps. Put this classic EQ right before your amp or distortion and hear the magic.	Band 1: 80Hz; Band 2: 240Hz ; Band 3: 750Hz Band 4: 2.2kHz; Band 5: 6.6kHz Use the five bands above to control the EQ level	

*The manufacturers and product names mentioned above are trademarks or registered trademarks of their respective owners. The trademarks were used merely to identify the sound character of the products.

Effect List

Effect Models List

FX Title	Description	Parameters & Ranges	Signal Processing
Graphic 7	This is a 7-band equalizer based on a widely used white guitar EQ pedal with max. ± 15 dB boost/cut range. You can use this EQ to control your sound, eliminate unwanted feedback, and expand your tone.	Band 1: 100Hz; Band 2: 200Hz; Band 3: 400Hz Band 4: 800Hz; Band 5: 1.6kHz; Band 6: 3.2kHz Band 7: 6.4kHz Use the seven bands above to control the center frequency. Level: Controls the output level by ± 15 dB	Mono I/O
Graphic 7B	This is a 7-band bass equalizer based on a widely used white bass EQ pedal with max. ± 15 dB boost/cut range. You can use this EQ to control your sound, eliminate unwanted feedback, and expand your tone.	Band 1: 50Hz; Band 2: 120Hz; Band 3: 400Hz Band 4: 500Hz; Band 5: 800kHz; Band 6: 4.5kHz Band 7: 10kHz Use the seven bands above to control the center frequency. Level: Controls the output level by ± 15 dB	
Para EQ 1	This is a 4-band parametric equalizer with low/high shelving filters that suitable for any instrument.	Band 1: 20Hz-2000Hz; Band 2, 3: 100Hz-10kHz Band 4: 200Hz-20kHz Use the four bands above to control the center frequency. Q 1-4: Controls the Q bandwidth Gain 1-4: Controls the EQ level by ± 12 dB Lo/Hi Shelf: Controls the overall low/high EQ level by ± 12 dB Volume: Controls the output level	Stereo/O
Para EQ 2	This is a 5-band parametric equalizer with selectable filter types that suitable for any instrument. Band 3 filter shape is fixed to Peak.	Freq 1-5: Controls the filter center frequency: -Freq 1: 20Hz-2000Hz -Freq 2, 3, 4: 100Hz-10kHz -Freq 5: 200Hz-20kHz Q 1-5: Controls the Q bandwidth Gain 1-5: Controls the EQ level by ± 12 dB Band 1/2/4/5 Type: Controls the band 1/2/4/5 filter shape: -Band 1/5: Lo/Hi Cut, Lo/Hi Shelf, Peak -Band 2/4: Lo/Hi Shelf, Peak Level: Controls the output level	
Graphic EQ	This is a 10-band equalizer suitable for any instrument.	Band 1: 31Hz; Band 2: 63Hz; Band 3: 125Hz Band 4: 250Hz; Band 5: 500Hz; Band 6: 1kHz Band 7: 2kHz; Band 8: 4kHz; Band 9: 8kHz Band 10: 16kHz Use the ten bands above to control the EQ level by ± 12 dB. Volume: Controls the output level	
MOD(27)			
Sync switch lets you control effect speed by Tap Tempo. When the Sync switch is on, turn the Rate knob to set a proper tap divide value. The default value is 1/4 (no division).			
Chorus(6)			
Aozora Chorus	Based on the legendary Arion® SCH-1 Stereo Chorus* pedal, this Aozora chorus brings you a beautiful 80s vibe, everything from classic chorus to killer rotary effects. Clapton and Landau loved this sound.	Depth: Controls the chorus depth Rate: Controls the chorus speed Tone: Controls the effect tone Sync: Switches Tap Tempo sync on/off	Mono in, stereo out

*The manufacturers and product names mentioned above are trademarks or registered trademarks of their respective owners. The trademarks were used merely to identify the sound character of the products.

Effect List

Effect Models List

FX Title	Description	Parameters & Ranges	Signal Processing
Grand Choruium	Based on the chorus mode of legendary 1970s ensemble chorus pedal, the Grand Choruium provides that timeless dreamy, warm, shimmering vintage analog chorus sound that musicians dream of.	Depth: Controls the chorus depth Rate: Controls the chorus speed E. Level: Controls the effect level Sync: Switches Tap Tempo sync on/off	Mono in, stereo out
Liquid C	Based on the legendary 4-button stereo chorus pedal, this Liquid C is more of a "dimension expander" than a chorus effect. Offering 4 finely tuned modes, this model adds unique spatial elements and subtle modulations to which nothing can compare.	Mode: Select from 4 different chorus modes	
Bass Chorus	This vintage-voiced chorus model is based on the famous ensemble chorus unit that tuned for bass players. Like its cousin, the Choruium B gives you a pure, lush tone. Individual effect level control offers more flexibility for bass.	Depth: Controls the vibrato depth Rate: Controls the vibrato rate E. Level: Controls the effect level Sync: Switches Tap Tempo sync on/off	
Liquid Dream	This model is based on the legendary Voodoo Lab® Analog Chorus* pedal. Offering you warm, organic sound and lush harmonics, it has become the standard by which all chorus pedals are measured. Fine tune the two parameters to get your own sound, from subtle doubling to sweet rotation!	Depth: Selects the chorus depth from deep to shallow Rate: Controls the chorus speed Sync: Switches Tap Tempo sync on/off	
3D Chorus	This is a multi-dimensional chorus model with independent depth controls for each audio channel (center, left and right). This super lush model will give you the real 3D experience for your ears (especially on stereo sound systems!).	Mix: Controls the wet/dry signal ratio Rate: Controls the chorus speed Filter: Controls the effect tone Depth L/C/R: Controls the chorus depth of left/right/center channels Sync: Switches Tap Tempo sync on/off	
Flanger(4)			
Flanger	This model produces the classic flanging effect originally achieved by manually, independently varying the speed of two tape recorders with the same program material. It produces a rich, natural flanging tone.	Depth: Controls the flanger depth Rate: Controls the flanger speed Pre Delay: Controls the pre delay time Feedback: Controls the amount of feedback Sync: Switches Tap Tempo sync on/off	Mono in, stereo out
Bass Flanger	This model achieves the classic flanging effect for bass players. It produces a rich, natural flanging tone.	Depth: Controls the flanger depth Rate: Controls the flanger speed Pre Delay: Controls the pre delay time Feedback: Controls the amount of feedback Sync: Switches Tap Tempo sync on/off	
Neg Flanger	This model produces a flanger effect with negative feedback, sounds like deep in the water, very unique flanging tone.	Depth: Controls the flanger depth Rate: Controls the flanger speed Pre Delay: Controls the pre delay time Feedback: Controls the amount of feedback Sync: Switches Tap Tempo sync on/off	
Trem Flanger	This model blended a classic flanging tone with a normal tremolo effect, you can adjust the flanger and tremolo parameters separately to get a distinctive sound.	Flg Depth: Controls the flanger depth Flg Rate: Controls the flanger speed Feedback: Controls the flanger feedback amount Trm Depth: Controls the tremolo depth Trm Rate: Controls the tremolo speed Flg Sync: Switches flanger Tap Tempo sync on/off Trm Sync: Switches tremolo Tap Tempo sync on/off	

*The manufacturers and product names mentioned above are trademarks or registered trademarks of their respective owners. The trademarks were used merely to identify the sound character of the products.

Effect List

Effect Models List

FX Title	Description	Parameters & Ranges	Signal Processing
Vibrato(4)			
Pulser	The Pulser is a rebirth of the super rare all-analog vintage vibrato pedal, which gives you a classic vibrato sound with true analog warmth. With simple DEPTH and RATE controls, it's easy to tweak your own unique texture, from slight vibes to a full-on wobble.	Depth: Controls the vibrato depth Rate: Controls the vibrato rate Sync: Switches Tap Tempo sync on/off	Mono in, stereo out
Grand Vibrato	Based on the vibrato mode of legendary 1970s ensemble chorus pedal the Grand Vibrato provides that timeless dreamy, warm, shimmering vintage analog vibrato sound that musicians dream of.	Depth: Controls the vibrato depth Rate: Controls the vibrato rate Level: Controls the effect output Sync: Switches Tap Tempo sync on/off	
Vibrato	This model is a typical vibrato effect with a wide controllable range. Use the Depth knob to vary the pitch, use the Rate knob to control the modulation speed.	Depth: Controls the vibrato depth Rate: Controls the vibrato speed Output: Controls the effect level Sync: Switches Tap Tempo sync on/off	
Vibrato T	This is a special vibrato effect with dynamic depth control, which lets you create touch-sensitive pitch modulation. Use the Rate knob to control the modulation speed; use the Sens knob to fine tune the sensitivity.	Sens: Controls the effect sensitivity Rate: Controls the vibrato speed Output: Controls the effect level Sync: Switches Tap Tempo sync on/off	
Phaser(7)			
90 Phaser	The 90 Phaser recreates the warm, rich analog phase sound of the legendary MXR® M101 Phase 90* pedal. Born in 1974, the one-knob orange phaser is an icon that has found a place on millions of pedal boards for over four decades.	Rate: Controls the phaser speed Sync: Switches Tap Tempo sync on/off	Mono in, stereo out
Green Phaser	This Green Phaser produces a sharp phase effect with a wide range from very slow to fast speed. This unique phasing sound has become popular among lots of musicians since 1977.	Depth: Controls the phaser depth Rate: Controls the phaser speed Sync: Switches Tap Tempo sync on/off	
Stone Phaser	The Stone Phaser is based on the legendary and extremely rare 1970s Electro-Harmonix® Small Stone phase shifter* pedal. This original is one of the best analog phaser sounds in the history of music and can be heard on countless rock recordings.	Color: Selects the phaser sound character from warm to sharp\ Rate: Controls the phaser speed Sync: Switches Tap Tempo sync on/off	
Notch Phaser	This model might be the craziest phaser ever – A phaser with 3 notch parameters! The 3 subtle Notch knobs will bring you lots of phasing combos from vintage, warm sounding to modern, sharp sounding. Create your own inspiration!	Depth: Controls the phaser depth Rate: Controls the phaser speed Level: Controls the effect level Notch 1-3: Controls the notch bandwidth of 3 different frequencies Sync: Switches Tap Tempo sync on/off	

*The manufacturers and product names mentioned above are trademarks or registered trademarks of their respective owners. The trademarks were used merely to identify the sound character of the products.

Effect List

Effect Models List

FX Title	Description	Parameters & Ranges	Signal Processing
Pan Phaser	This is a special phaser that combines tremolo/pan variations. Featuring subtle, bright phasing tone and smooth panning tone, you get some seriously trippy psychedelic mojo here.	Pan Depth: Controls the tremolo depth (using mono output) or panning depth (using stereo output) Pan Rate: Controls the tremolo speed (using mono output) or panning speed (using stereo output) Phaser Depth: Controls the phaser depth Phaser Rate: Controls the phaser speed Phs Sync: Switches phaser Tap Tempo sync on/off Pan Sync: Switches tremolo/pan Tap Tempo sync on/off	
Minivibe	This model delivers a lush rotating effect that simulates 1960s rotary speakers. Based on the Voodoo Lab® Micro Vibe*, it gives you the pure, "psychedelic" vibe-y taste that guitar heroes like Hendrix and Gilmour loved.	Depth: Controls the effect depth Rate: Controls the effect speed Sync: Switches Tap Tempo sync on/off	Mono in, stereo out
Revolver	This is perhaps one of the most unique "must-try" effects ever conceived. The Revolver is based on the legendary vintage Shin-ei® Uni-Vibe®* pedal. The Uni-Vibe®* was designed to simulate the sound of a rotary speaker, but the "failed" attempt has been embraced as one of the most iconic effects in rock 'n' roll history. Kick it on and feel the legendary psycho sound of the Revolver!	Depth: Controls the effect depth Rate: Controls the effect speed Volume: Controls the effect output Mode: Select from 2 different vibe modes: Chorus and Vibrato Sync: Switches Tap Tempo sync on/off	
Tremolo(2)			
Helicopter	This model is based on the legendary Demeter® TRM-1 Tremulator®* tremolo pedal. Featuring deep, pulsing optical tremolo sound, it recreates the classic tremolo effect found on many vintage amps but with a greater range of speed and depth.	Depth: Controls the tremolo depth Rate: Controls the tremolo speed Sync: Switches Tap Tempo sync on/off	Mono in, stereo out
Custom Trem	With 4 different waveforms to choose from, Custom Trem will be the all-star of all your tremolo pedals. The Color and Shape knobs ensure super wide tonal range and flavor.	Depth: Controls the tremolo depth Rate: Controls the tremolo speed Volume: Controls the effect output Color: Controls the tremolo tone Shape: Selects the waveforms from sine wave, triangle wave, square wave and sawtooth wave Bias: Controls the bias/offset of different waveforms Sync: Switches Tap Tempo sync on/off	
Rotary(1)			
Rotary	This model is a rotary speaker simulator with detailed control, bringing you the legendary tone adapted by lots of rock legends.	Mix: Controls the wet/dry signal ratio Bass/Horn speed: Controls the bass/horn rotating speed B. /H. Intensity: Controls the bass/horn intensity Balance: Controls the bass/horn sound balance Pan: Controls the effect L/R panning Tone: Controls the effect tone Bass/Horn Sync: Switches Tap Tempo sync on/off	Mono in, stereo out

*The manufacturers and product names mentioned above are trademarks or registered trademarks of their respective owners. The trademarks were used merely to identify the sound character of the products.

Effect List

Effect Models List

FX Title	Description	Parameters & Ranges	Signal Processing
Expanding(2)			
Classic Stereolizer	This model is a stereo expander based on Precedence Effect which delays the right output a bit to create an expanded stereo sound.	Width: Controls the stereo expansion width Phase Reverse: Switches phase reversing on/off on each channel Level L/R: Controls the L/R channels output Output: Controls the overall output	Stereo I/O
Modern Stereolizer	This model is a stereo expander based on modern methods which creates an expanded stereo sound without phasing problems. Please note we don't recommend to apply this with one side of a stereo output of an effect module.	Width: Controls the stereo expansion width Depth: Controls the effect depth Low Cut/High Cut: Cuts the effect low/high signal Output: Controls the overall output	
Slow Attack(1)			
Sweller	This model is auto swell effect that creating a violin-like tone. Two parameters make it simple.	Attack: Controls how fast the effect swells the input signal Curve: Selects the volume swell curve Side Chain: Selects side chain key input source: -Input L/R: Input jacks -FX RTN L/R: FX Loop return jack -Prev FX: Output signal of previous effect slot; if you select this, we recommend you to place this effect before amp/drive effects	Mono I/O
DLY(27)			
Analog Delay M	This is a mono analog delay model that captures the sound of a vintage analog delay machine: warm and natural, just like old times! You can use Tap Tempo function to control the delay time by turning on the Sync switch. When the Sync switch is on, turn the Time knob to set a proper tap divide value. The default value is 1/4 (no division).	Mix: Controls the wet/dry signal ratio Feedback: Controls the amount of feedback Time: Controls the delay time Level: Controls the effect output Sync: Switches Tap Tempo sync on/off Trail: Switched effect trail on/off when the effect is bypassed	Mono I/O
Analog Delay S	This is a stereo analog delay model that captures the sound of a vintage analog delay machine: warm and natural, just like old times! You can use Tap Tempo function to control the delay time by turning on the Sync switch. When the Sync switch is on, turn the Time knob to set a proper tap divide value. The default value is 1/4 (no division).	Mix: Controls the wet/dry signal ratio Feedback: Controls the amount of feedback Time: Controls the delay time of left channel Time R%: Controls the delay time of right channel (time ratio of left channel) Spread: Controls the effect stereo width Level: Controls the effect output Sync: Switches Tap Tempo sync on/off Trail: Switched effect trail on/off when the effect is bypassed	Stereo I/O
BBD Delay M	This is a mono analog delay model that captures the sound of a BBD based analog delay machine that is warm, smooth, rounded due to the limitation of BBD chips. You can use Tap Tempo function to control the delay time by turning on the Sync switch. When the Sync switch is on, turn the Time knob to set a proper tap divide value. The default value is 1/4 (no division).	Mix: Controls the wet/dry signal ratio Feedback: Controls the amount of feedback Time: Controls the delay time Level: Controls the effect output Sync: Switches Tap Tempo sync on/off Trail: Switched effect trail on/off when the effect is bypassed	Mono I/O

*The manufacturers and product names mentioned above are trademarks or registered trademarks of their respective owners. The trademarks were used merely to identify the sound character of the products.

Effect List

Effect Models List

FX Title	Description	Parameters & Ranges	Signal Processing
BBD Delay S	<p>This is a stereo analog delay model that captures the sound of a BBD based analog delay machine that is warm, smooth, rounded due to the limitation of BBD chips. You can use Tap Tempo function to control the delay time by turning on the Sync switch. When the Sync switch is on, turn the Time knob to set a proper tap divide value. The default value is 1/4 (no division).</p>	<p>Mix: Controls the wet/dry signal ratio Feedback: Controls the amount of feedback Time: Controls the delay time of left channel Time R%: Controls the delay time of right channel (time ratio of left channel) Spread: Controls the effect stereo width Level: Controls the effect output Sync: Switches Tap Tempo sync on/off Trail: Switched effect trail on/off when the effect is bypassed</p>	Stereo I/O
Digital Delay M	<p>This model is a mono digital delay that produces a pure clean delay sound, clear and accurate. You can use Tap Tempo function to control the delay time by turning on the Sync switch. When the Sync switch is on, turn the Time knob to set a proper tap divide value. The default value is 1/4 (no division).</p>	<p>Mix: Controls the wet/dry signal ratio Feedback: Controls the amount of feedback Time: Controls the delay time Level: Controls the effect output Sync: Switches Tap Tempo sync on/off Trail: Switched effect trail on/off when the effect is bypassed</p>	Mono I/O
Digital Delay S	<p>This model is a stereo digital delay that produces a pure clean delay sound, clear and accurate. You can use Tap Tempo function to control the delay time by turning on the Sync switch. When the Sync switch is on, turn the Time knob to set a proper tap divide value. The default value is 1/4 (no division).</p>	<p>Mix: Controls the wet/dry signal ratio Feedback: Controls the amount of feedback Time: Controls the delay time of left channel Time R%: Controls the delay time of right channel (time ratio of left channel) Spread: Controls the effect stereo width Level: Controls the effect output Sync: Switches Tap Tempo sync on/off Trail: Switched effect trail on/off when the effect is bypassed</p>	Stereo I/O
Tape Delay M	<p>Back in the old days, producers and engineers created delay and echo effects using tape machines. That sweet, space-like echo tone is still popular today, especially among psychedelic musicians. This is a mono delay model that captures the characteristics of the sound of a tape echo machine. Just plug in and play, and time flows back! You can use Tap Tempo function to control the delay time by turning on the Sync switch. When the Sync switch is on, turn the Time knob to set a proper tap divide value. The default value is 1/4 (no division).</p>	<p>Mix: Controls the wet/dry signal ratio Feedback: Controls the amount of feedback Time: Controls the delay time Wow & Flutter: Controls the delay pitch/speed variation amount caused by malfunctioning tape/motor Age: Selects from 3 tone variations Spread: Controls the effect stereo width Drive: Controls the delay distortion amount Level: Controls the effect output Sync: Switches Tap Tempo sync on/off Trail: Switched effect trail on/off when the effect is bypassed</p>	Mono I/O

*The manufacturers and product names mentioned above are trademarks or registered trademarks of their respective owners. The trademarks were used merely to identify the sound character of the products.

Effect List

Effect Models List

FX Title	Description	Parameters & Ranges	Signal Processing
Tape Delay S	<p>Back in the old days, producers and engineers created delay and echo effects using tape machines. That sweet, space-like echo tone is still popular today, especially among psychedelic musicians.</p> <p>This is a stereo delay model that captures the characteristics of the sound of a tape echo machine. Just plug in and play, and time flows back! You can use Tap Tempo function to control the delay time by turning on the Sync switch. When the Sync switch is on, turn the Time knob to set a proper tap divide value. The default value is 1/4 (no division).</p>	<p>Mix: Controls the wet/dry signal ratio Feedback: Controls the amount of feedback Time: Controls the delay time of left channel Time R%: Controls the delay time of right channel (time ratio of left channel) Spread: Controls the effect stereo width Wow & Flutter: Controls the delay pitch/speed variation amount caused by malfunctioning tape/motor Age: Selects from 3 tone variations Spread: Controls the effect stereo width Scrape: Controls the tape scratch amount Drive: Controls the delay distortion amount Level: Controls the effect output Sync: Switches Tap Tempo sync on/off Trail: Switched effect trail on/off when the effect is bypassed</p>	Stereo I/O
Dual Delay	<p>This model is a stereo dual delay effect with separated left/right channel signal processing and individual parameter control on both sound channels.</p> <p>You can use Tap Tempo function to control the delay time by turning on the Sync switch. When the Sync switch is on, turn the Time knob to set a proper tap divide value. The default value is 1/4 (no division).</p>	<p>Mix: Controls the wet/dry signal ratio Time L/R: Controls the delay time on left/right channels FB L to L/R: Controls the left channel feedback amount on left/right channels FB R to L/R: Controls the right channel feedback amount on left/right channels Low Cut/High Cut: Controls the effect low/high frequency cutoff L/R Sync: Switches delay time Tap Tempo sync on/off on left/right channels Trail: Switched effect trail on/off when the effect is bypassed</p>	
Ping-Pong	<p>This model is a ping-pong delay producing stereo feedback that bounces back and forth between the left and right channels.</p> <p>You can use Tap Tempo function to control the delay time by turning on the Sync switch. When the Sync switch is on, turn the Time knob to set a proper tap divide value. The default value is 1/4 (no division).</p>	<p>Mix: Controls the wet/dry signal ratio Feedback: Controls the amount of feedback Time: Controls the delay time of left channel Time R%: Controls the delay time of right channel (time ratio of left channel) Spread: Controls the effect stereo width Level: Controls the effect output Sync: Switches Tap Tempo sync on/off Trail: Switched effect trail on/off when the effect is bypassed</p>	
Sweep Delay	<p>This delay model has a sweep filter affecting the delay repeats, which creates a unique sweeping delay sound.</p> <p>You can use Tap Tempo function to control the delay time/effect speed by turning on the Sync switch. When the Sync switch is on, turn the Time/Sweep Rate knob to set a proper tap divide value. The default value is 1/4 (no division).</p>	<p>Mix: Controls the wet/dry signal ratio Feedback: Controls the amount of feedback Time: Controls the delay time Sweep Depth: Controls the sweep filter depth Sweep Rate: Controls the sweep filter speed Level: Controls the effect output Time Sync: Switches delay Tap Tempo sync on/off Rate Sync: Switches sweep filter Tap Tempo sync on/off Trail: Switched effect trail on/off when the effect is bypassed</p>	

*The manufacturers and product names mentioned above are trademarks or registered trademarks of their respective owners. The trademarks were used merely to identify the sound character of the products.

Effect List

Effect Models List

FX Title	Description	Parameters & Ranges	Signal Processing
Tremolo Delay	<p>This delay model comes with a unique tremolo that affects only the delay repeats. This is perfect for soundscapes cool and even creepy.</p> <p>You can use Tap Tempo function to control the delay time/effect speed by turning on the Sync switch. When the Sync switch is on, turn the Time/Trem Rate knob to set a proper tap divide value. The default value is 1/4 (no division).</p>	<p>Mix: Controls the wet/dry signal ratio</p> <p>Feedback: Controls the amount of feedback</p> <p>Time: Controls the delay time</p> <p>Level: Controls the effect output</p> <p>Trem Depth: Controls the tremolo depth</p> <p>Trem Rate: Controls the tremolo speed</p> <p>Trem Sync: Switches tremolo Tap Tempo sync on/off</p> <p>Time Sync: Switches delay Tap Tempo sync on/off</p> <p>Trail: Switched effect trail on/off when the effect is bypassed</p>	Stereo I/O
Lo-Fi Delay	<p>This delay model comes with a bitcrusher that affects only the delay repeats, producing lo-fi'd feedback.</p> <p>You can use Tap Tempo function to control the delay time by turning on the Sync switch. When the Sync switch is on, turn the Time knob to set a proper tap divide value. The default value is 1/4 (no division).</p>	<p>Mix: Controls the wet/dry signal ratio</p> <p>Feedback: Controls the amount of feedback</p> <p>Time: Controls the delay time</p> <p>Downsampling: Controls the effect downsampling rate</p> <p>Bit Reduction: Controls the effect bit depth reducing amount</p> <p>Level: Controls the effect output</p> <p>Sync: Switches Tap Tempo sync on/off</p> <p>Trail: Switched effect trail on/off when the effect is bypassed</p>	
Ring Delay	<p>This delay model comes with ring modulation that alters only the delay repeats, producing inharmonic feedback.</p> <p>You can use Tap Tempo function to control the delay time by turning on the Sync switch. When the Sync switch is on, turn the Time knob to set a proper tap divide value. The default value is 1/4 (no division).</p>	<p>Mix: Controls the delay wet/dry signal ratio</p> <p>Feedback: Controls the amount of feedback</p> <p>Time: Controls the delay time</p> <p>Ring Mix: Controls the ring mod wet/dry signal ratio</p> <p>Ring Freq: Controls the ring mod frequency</p> <p>Level: Controls the effect output</p> <p>Sync: Switches Tap Tempo sync on/off</p> <p>Trail: Switched effect trail on/off when the effect is bypassed</p>	
Reverse Delay	<p>Kick it on and — !sdrawkcab seog gnihtyrevE</p> <p>This is a delay model that reverses the original sound. It's like we recorded your sound with a tape recorder and then played it backwards.</p> <p>That's where this model goes.</p> <p>You can use Tap Tempo function to control the delay time by turning on the Sync switch. When the Sync switch is on, turn the Time knob to set a proper tap divide value. The default value is 1/4 (no division).</p>	<p>Mix: Controls the wet/dry signal ratio</p> <p>Feedback: Controls the amount of feedback</p> <p>Time: Controls the delay time</p> <p>Level: Controls the effect output</p> <p>Sync: Switches Tap Tempo sync on/off</p> <p>Trail: Switched effect trail on/off when the effect is bypassed</p>	
Vintage Rack	<p>This delay model captures the sound of a vintage 1980's rack-mount delay machine with slightly sample-reduced feedback. Rack delay was the thing back then. Every rad rocker had one.</p> <p>You can use Tap Tempo function to control the delay time by turning on the Sync switch. When the Sync switch is on, turn the Time knob to set a proper tap divide value. The default value is 1/4 (no division).</p>	<p>Mix: Controls the wet/dry signal ratio</p> <p>Feedback: Controls the amount of feedback</p> <p>Time: Controls the delay time</p> <p>Mod: Controls the effect modulation amount</p> <p>Tone: Controls the effect tone</p> <p>Sync: Switches Tap Tempo sync on/off</p> <p>Trail: Switched effect trail on/off when the effect is bypassed</p>	

*The manufacturers and product names mentioned above are trademarks or registered trademarks of their respective owners. The trademarks were used merely to identify the sound character of the products.

Effect List

Effect Models List

FX Title	Description	Parameters & Ranges	Signal Processing
Ambience 1	This model is a multi-tap delay that brings you expanded sound spaciousness. 1, 2 stands for different tonal variations. You can use Tap Tempo function to control the delay time by turning on the Sync switch. When the Sync switch is on, turn the Time knob to set a proper tap divide value. The default value is 1/4 (no division).	Mix: Controls the wet/dry signal ratio Feedback: Controls the amount of feedback Time: Controls the delay time Level: Controls the effect output Mod: Controls the effect modulation amount Tone: Controls the effect tone Sync: Switches Tap Tempo sync on/off Trail: Switched effect trail on/off when the effect is bypassed	
Ambience 2	This model is a multi-tap delay that brings you expanded sound spaciousness. 1, 2 stands for different tonal variations. You can use Tap Tempo function to control the delay time by turning on the Sync switch. When the Sync switch is on, turn the Time knob to set a proper tap divide value. The default value is 1/4 (no division).		
Infidelay 1	This model is a complex delay features 4 delay lines and a feedback matrix, generating an ethereal, shimmering delay effect. 1, 2 stands for different tonal variations. You can use Tap Tempo function to control the delay time by turning on the Sync switch. When the Sync switch is on, turn the Time knob to set a proper tap divide value. The default value is: Time 1=1/4 (no division), Time 2=1/8, Time 3=1/8D, Time 4=1/4D.	Mix: Controls the wet/dry signal ratio Feedback: Controls the amount of feedback Time 1-4: Controls the delay 1-4 time Level 1-4: Controls the delay 1-4 output Pan 1-4: Controls the delay 1-4 L/R panning Output: Controls the overall output Mod: Controls the effect modulation amount Tone: Controls the effect tone Sync: Switches delay 1-4 Tap Tempo sync on/off Trail: Switched effect trail on/off when the effect is bypassed	Stereo I/O
Infidelay 2	This model is a complex delay features 4 delay lines and a feedback matrix, generating an ethereal, shimmering delay effect. 1, 2 stands for different tonal variations. You can use Tap Tempo function to control the delay time by turning on the Sync switch. When the Sync switch is on, turn the Time knob to set a proper tap divide value. The default value is: Time 1=1/4 (no division), Time 2=1/8, Time 3=1/8D, Time 4=1/4D.		
Sweetie	This model produces THAT legendary warm, natural analog BBD delay peal sound (the pedal with a wine red chassis and REPEAT RATE control) which is highly praised by musicians. Now the legend is back! You can use Tap Tempo function to control the delay time by turning on the Sync switch. When the Sync switch is on, turn the Time knob to set a proper tap divide value. The default value is 1/4 (no division).	Mix: Controls the wet/dry signal ratio Feedback: Controls the amount of feedback Time: Controls the delay time Sync: Switches Tap Tempo sync on/off Trail: Switched effect trail on/off when the effect is bypassed	Mono I/O

*The manufacturers and product names mentioned above are trademarks or registered trademarks of their respective owners. The trademarks were used merely to identify the sound character of the products.

Effect List

Effect Models List

FX Title	Description	Parameters & Ranges	Signal Processing
Recaller	<p>Like syrup on waffles.</p> <p>This model is based on the legendary Electro-Harmonix® Deluxe Memory Man® Solid State Echo/Analog Delay Line* pedal (early 4-knob "Blue Face" version with SAD1024 IC), the godfather of analog delay. Dig in and see how one pedal can fill in everything that's still missing in your hit song.</p> <p>You can use Tap Tempo function to control the delay time by turning on the Sync switch. When the Sync switch is on, turn the Time knob to set a proper tap divide value. The default value is 1/4 (no division).</p>		
Ekopress 80	<p>The Ekopress 80 is based on the legendary Maxon® AD80 Analog Delay* pedal (early MN3005 version). True to its bloodline, it is indubitably the expressway to analog heaven. Ekopress 80 features a smooth, organic analog delay tone with great dynamic response and slightly lo-fi'd repeats.</p> <p>You can use Tap Tempo function to control the delay time by turning on the Sync switch. When the Sync switch is on, turn the Time knob to set a proper tap divide value. The default value is 1/4 (no division).</p>	<p>Mix: Controls the wet/dry signal ratio</p> <p>Feedback: Controls the amount of feedback</p> <p>Time: Controls the delay time</p> <p>Sync: Switches Tap Tempo sync on/off</p> <p>Trail: Switched effect trail on/off when the effect is bypassed</p>	Mono I/O
Ekopress 900	<p>Get on the expressway to pure analog heaven!</p> <p>The Ekopress 900 is based on the legendary Maxon® AD900 Analog Delay* pedal. The tone is pure, rich, and clear, and it faithfully reacts to your playing style.</p> <p>You can use Tap Tempo function to control the delay time by turning on the Sync switch. When the Sync switch is on, turn the Time knob to set a proper tap divide value. The default value is 1/4 (no division).</p>		
Ekopress 999	<p>Cruise the expressway to pure analog heaven!</p> <p>The Ekopress 999 is based on the legendary Maxon® AD999 Analog Delay* pedal which provides a warm, rich, organic analog delay tone with some dynamic distortion on the repeats. Crank the Feedback knob to get into sweet self-oscillation, which sounds different than its brother, Ekopress 900.</p> <p>You can use Tap Tempo function to control the delay time by turning on the Sync switch. When the Sync switch is on, turn the Time knob to set a proper tap divide value. The default value is 1/4 (no division).</p>		

*The manufacturers and product names mentioned above are trademarks or registered trademarks of their respective owners. The trademarks were used merely to identify the sound character of the products.

Effect List

Effect Models List

FX Title	Description	Parameters & Ranges	Signal Processing
2290 Mod	<p>This model is based on the delay sound of the legendary TC Electronic® 2290 Dynamic Digital Delay + Effects Controls Processor* rack mount effect unit, which is widely used among countless musicians and studio producers.</p> <p>You can use Tap Tempo function to control the delay time by turning on the Sync switch. When the Sync switch is on, turn the Time knob to set a proper tap divide value. The default value is 1/4 (no division).</p>	<p>Mix: Controls the wet/dry signal ratio</p> <p>Feedback: Controls the amount of feedback</p> <p>Time: Controls the delay time</p> <p>Mod Rate: Controls the delay modulation speed</p> <p>Mod Depth: Controls the delay modulation depth</p> <p>Phase Reverse: Switches delay phase reversing on/off on each channel</p> <p>Low Cut/High Cut: Cuts delay low/high signal at selected frequency points</p> <p>Level: Controls the effect output</p> <p>Sync: Switches Tap Tempo sync on/off</p> <p>Trail: Switched effect trail on/off when the effect is bypassed</p>	Stereo I/O
2290 Ducker	<p>A ducking delay reduces delay effect level when you pluck the string hard. This model is a ducking delay based on the delay sound of the legendary TC Electronic® 2290 Dynamic Digital Delay + Effects Controls Processor* rack mount effect unit, which is widely used among countless musicians and studio producers.</p> <p>You can use Tap Tempo function to control the delay time by turning on the Sync switch. When the Sync switch is on, turn the Time knob to set a proper tap divide value. The default value is 1/4 (no division).</p>	<p>Mix: Controls the wet/dry signal ratio</p> <p>Feedback: Controls the amount of feedback</p> <p>Time: Controls the delay time</p> <p>Sens: Controls the ducking sensitivity</p> <p>Attenuate: Controls the delay signal attenuate amount</p> <p>Release: Controls how fast the delay signal goes back to normal</p> <p>Phase Reverse: Switches delay phase reversing on/off on each channel</p> <p>Low Cut/High Cut: Cuts delay low/high signal at selected frequency points</p> <p>Level: Controls the effect output</p> <p>Sync: Switches Tap Tempo sync on/off</p> <p>Trail: Switched effect trail on/off when the effect is bypassed</p>	
RVB(11)			
Studio	This reverb model recreates the spaciousness of a recording studio.	<p>Mix: Controls the wet/dry signal ratio</p> <p>Pre Delay: Controls the amount of time between the dry signal and the audible onset of early reflections and the reverb tail</p> <p>Decay: Controls the duration of reverb time</p> <p>Low Damp/Hi Damp: Dampens the effect low/high frequency amount</p> <p>Mod: Controls the effect modulation amount</p> <p>Trail: Switched effect trail on/off when the effect is bypassed</p>	Stereo I/O
Club	This reverb model recreates the spaciousness of a club.		
Concert	This reverb model recreates the spaciousness of a concert hall.		
Arena	This reverb model recreates the spaciousness of a live arena.		
Small Plate	This reverb model simulates a small plate reverberator.		
Large Plate	This reverb model simulates a large plate reverberator.		
Combo Spring	This reverb model simulates the solid state spring reverb module coming from a combo amp.		
Tube Spring	This reverb model simulates the sound coming from a vintage tube driven spring reverb unit.		

*The manufacturers and product names mentioned above are trademarks or registered trademarks of their respective owners. The trademarks were used merely to identify the sound character of the products.

Effect List

Effect Models List

FX Title	Description	Parameters & Ranges	Signal Processing
Shimmer 1	This reverb model creates a lush, shimmering reverb sound. 1,2 stands for different sound variations.	Mix: Controls the wet/dry signal ratio Pre Delay: Controls the amount of time between the dry signal and the audible onset of early reflections and the reverb tail	Stereo I/O
Shimmer 2	This reverb model creates a lush, shimmering reverb sound. 1,2 stands for different sound variations.	Decay: Controls the duration of reverb time Low Damp/Hi Damp: Dampens the effect low/high frequency amount	
Cloud	This reverb model creates a huge, thick reverb effect like curly clouds in the sky.	Mod: Controls the effect modulation amount Trail: Switched effect trail on/off when the effect is bypassed	
FX SND			
FX Loop Send	This is for FX Loop Send jack settings.	Type: Selects the output type (channel) Send Level: Controls the output level to FX Loop Send jack Thru Level: Controls the output level to Ampero II Stomp's signal chain (or to the next effect module); set it to Mute to use as a serial FX Loop	Stereo I/O
FX RTN			
FX Loop Return	This is for FX Loop Return jack settings.	Type: Selects the output type (channel) Return Level: Controls the FX Loop return jack input level Mix: Controls the signal ratio between the FX loop signal and the signal coming from Ampero II Stomp's signal chain; set it to 100 to use as a serial FX Loop	Stereo I/O
FX LOOP			
FX Loop	This is for entire FX Loop settings.	Type: Selects the output type (channel) Send Level: Controls the output level to FX Loop Send jack Return Level: Controls the FX Loop return jack input level Mix: Controls the signal ratio between the FX loop signal and the signal coming from Ampero II Stomp's signal chain; set it to 100 to use as a serial FX Loop	Stereo I/O
VOL			
Volume	This is a simple volume controller effect that acts like a volume pedal. Assign the Volume parameter to your expression pedal, turn the expression pedal on, and you can use it as a volume pedal.	Volume: Controls the output volume	Stereo I/O*

*Process left channel signal only when inputting stereo signal

The manufacturers and product names mentioned above are trademarks or registered trademarks of their respective owners. The trademarks were used merely to identify the sound character of the products.

Effect List

MIDI Control Information List

CC#	Value	Description
0	0-2	Bank MSB: P00-1~P42-2: CC 0=0, PC=0-127 P42-3~P85-1: CC 0=1, PC=0-127 P85-2~P99-3: CC 0=2, PC=0-43
7	0-100	Patch Volume
11	0-127	Expression Pedal
13	0-127	EXP On/Off: 0-63: Off 64-127: On
16	0-127	Quick Access Para 1
17	0-127	Quick Access Para 1 parameter adjustment: 0-63: Turn down by 1 step 64-127: Turn up by 1 step
18	0-127	Quick Access Para 2
19	0-127	Quick Access Para 2 parameter adjustment: 0-63: Turn down by 1 step 64-127: Turn up by 1 step
20	0-127	Quick Access Para 3
21	0-127	Quick Access Para 3 parameter adjustment: 0-63: Turn down by 1 step 64-127: Turn up by 1 step
22	0-127	Bank - (initial mode)
23	0-127	Bank + (initial mode)
24	0-127	Bank - (wait mode)
25	0-127	Bank + (wait mode)
26	0-127	Patch -
27	0-127	Patch +
28	0-127	Unit Mode: 0-63: Stomp Mode 64-127: Patch Mode
29	0-127	Main Display Mode: 0-63: Mode 1 64-127: Mode 2
48	0-127	Slot A1 On/Off: 0-63: Off 64-127: On
49	0-127	Slot A2 On/Off: 0-63: Off 64-127: On
50	0-127	Slot A3 On/Off: 0-63: Off 64-127: On

CC#	Value	Description
51	0-127	Slot A4 On/Off: 0-63: Off 64-127: On
52	0-127	Slot A5 On/Off: 0-63: Off 64-127: On
53	0-127	Slot A6 On/Off: 0-63: Off 64-127: On
54	0-127	Slot B1 On/Off: 0-63: Off 64-127: On
55	0-127	Slot B2 On/Off: 0-63: Off 64-127: On
56	0-127	Slot B3 On/Off: 0-63: Off 64-127: On
57	0-127	Slot B4 On/Off: 0-63: Off 64-127: On
58	0-127	Slot B5 On/Off: 0-63: Off 64-127: On
59	0-127	Slot B6 On/Off: 0-63: Off 64-127: On
60	0-127	Tuner On/Off: 0-63: Off 64-127: On
62	0-127	Looper Menu On/Off 0-63: Off 64-127: On
63	0-127	Looper Rec/Overdub
64	0-127	Looper Play/Stop 0-63: Stop 64-127: Play
65	0-127	Looper Speed 0-63: 1/2 Speed 64-127: Normal
66	0-127	Looper Playback 0-63: Reverse 64-127: Normal
67	0-127	Looper Undo/Redo

Effect List

MIDI Control Information List

CC#	Value	Description
68	0-127	Looper Clear
69	0-100	Looper Rec Level
70	0-100	Looper Loop Level
71	0-127	Looper Pre/Post 0-63: Post 64-127: Pre
72	0-127	Looper A/B Chain 0-63: Chain A 64-127: Chain B
73	0-127	CTRL: Status A (red LED): 0-63 Status B (green LED): 64-127
74	0-2	Tempo MSB CC74=0, CC75=40-127: 40BPM-127BPM CC74=1, CC75=0-127: 128BPM-255BPM CC74=2, CC75=0-44: 256BPM-300BPM
75	0-127	Tempo LSB
76	0-127	Tap Tempo
77	0-127	Screen Lock/Unlock Lock: 0-63 Unlock: 64-127

Troubleshooting

Device won't turn on

- Make sure the power supply is properly connected and the device is switched on.
- Check if the power adapter is working properly.
- Check if you're using the correct power adapter.

No sound or slight sound

- Make sure your cables are connected properly.
- Make sure the volume knob is adjusted properly.
- When the expression pedal is used for volume control, check its position and volume settings.
- Check the effects module volume settings.
- Check the patch volume settings.
- Make sure your input device is not muted.
- Make sure OUTPUT/FX SND SOURCE in GLOBAL - I/O menu is set to Normal.
- If you're using a noise gate, please make sure the Side Chain parameter is correctly set to match the input jack you're using.

Noise

- Make sure your cables are connected properly.
- Check your instrument output jack.
- Check if you're using the correct power adapter.
- If the noise is coming from your instrument, try using the noise reduction module to adjust it.

Sound problems

- Make sure your cables are connected properly.
- Check your instrument output jack.
- If you're using an external expression pedal to control distortion or other similar parameters, check to see if the expression pedal is set up properly.
- Check your effects parameter setup. If effects are set to extremes, Ampero II Stomp may only emit noise.

FX loop problems

- Make sure FX SND/RTN/LOOP modules are added on effects chain.
- Make sure FX SND/RTN/LOOP module parameters and input/output nodes, global settings that related to FX loop jacks are set properly.
- When using stereo connection, a Y cable (one TRS jack to two TS jacks) is needed and should be wired as below:

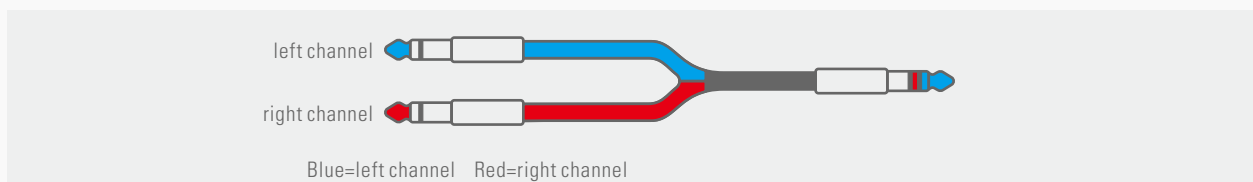

Problems with expression pedal

- Check your expression pedal on/off settings.
- Try calibrating the pedal.
- When using an external expression pedal, make sure you're using a 1/4" male-to-male TRS cable.

Technical Specifications

Effects Digital Audio Signal Processing: 24-bit depth, 44.1kHz sample rate

Frequency Response: 20Hz – 20kHz \pm 1dB

Dynamic Range: Max. 127dB (digital to analog)

Effects: 460 (incl. global EQ)

No. of Effect Modules: 16

Effects Slots: Total of 12 simultaneous effects slots

Patches: 300

Looper Time: Stereo 60 seconds

Inputs:

Two 1/4" Tip Sleeve (TS) instrument jacks with individual input mode selector

One 1/8" Stereo Auxiliary In (Aux In) jack

One 1/4" Tip Ring Sleeve (TRS) expression pedal/momentary footswitch input (EXP/CTRL) jack

One 1/4" Tip Ring Sleeve (TRS) unbalanced stereo FX loop return jack

One Standard 5 pin MIDI input jack

Outputs:

Two 1/4" Tip Ring Sleeve (TRS) balanced stereo output jacks

One 1/4" Tip Ring Sleeve (TRS) unbalanced stereo FX loop send jack

One 1/8" stereo headphones output jack

One standard 5 pin MIDI output jack

Input Impedance:

Input: E.GT: 1M Ω ; A.GT: 4.7M Ω ; LINE: 10k Ω

FX Loop Return: 100k Ω

Aux In: 10k Ω

Output Impedance:

Output: 1k Ω

FX Loop Send: 1k Ω

Headphones: 47 Ω

Input Level:

Input: -17.78dBu (Nominal); 14.5dBu (Max)

FX Loop Return: -17.78dBu (Nominal); 14.5dBu (Max)

Aux In: -17.78dBu (Nominal); 20dBu (Max)

Output Level:

Output: -11.76dBu (Nominal); 26.25dBu (Max)

FX Loop Send: -17.78dBu (Nominal); 14.5dBu (Max)

Headphones: -7.4dBu (Nominal); 18.3dBu (Max)

Screen: 4" 800 x 480 Color Dynamic Display Touch Screen

USB Port: USB 2.0 Type-C port, supports USB Audio 2.0

Impulse Response/IR processing: Supports 24-bit/44.1kHz Mono WAV files, 1024 and 2048 points; Supports up to 50 user IRs

Power Requirements: 9-18V DC Center Negative

Current Consumption: 800mA Max (9V DC)

Dimensions: 185mm(W) x 145mm(D) x 58mm(H)

Weight: 1050g