

nord drum 3P

modeling percussion synthesizer

User Manual

English

Nord Drum 3P

OS Version: 1.x

Edition: C



CAUTION: TO REDUCE THE RISK OF ELECTRIC SHOCK DO NOT REMOVE COVER (OR BACK). NO USER SERVICEABLE PARTS INSIDE. REFER SERVICING TO QUALIFIED PERSONNEL.

ATTENTION: POUR EVITER LES RISQUES DE CHOC ELECTRIQUE, NE PAS ENLEVER LE COUVERCLE.

AUCUN ENTRETIEN DE PIECES INTERIEURES PAR L'USAGER. CONFIER L'ENTRETIEN AU PERSONNEL QUALIFE.

AVIS: POUR EVITER LES RISQUES D'INCIDENTE OU D'ELECTROCUTION, N'EXPOSEZ PAS CET ARTICLE A LA PLUIE OU L'HUMIDITET.



The lightning flash with the arrowhead symbol within an equilateral triangle is intended to alert the user to the presence of uninsulated voltage within the products enclosure that may be of sufficient magnitude to constitute a risk of electric shock to persons.

Le symbole éclair avec le point de flèche à l'intérieur d'un triangle équilatéral est utilisé pour alerter l'utilisateur de la présence à l'intérieur du coffret de "voltage dangereux" non isolé d'ampleur suffisante pour constituer un risque d'électrocution.



The exclamation mark within an equilateral triangle is intended to alert the user to the presence of important operating and maintenance (servicing) instructions in the literature accompanying the product.

Le point d'exclamation à l'intérieur d'un triangle équilatéral est employé pour alerter l'utilisateur de la présence d'instructions importantes pour le fonctionnement et l'entretien (service) dans le livret d'instructions accompagnant l'appareil.

Instructions pertaining to a risk of fire, electric shock or injury to persons.

IMPORTANT SAFETY INSTRUCTIONS

SAVE THESE INSTRUCTIONS

Warning - When using electric products, basic precautions should always be followed, including the following:

- 1) Read these instructions.
- 2) Keep these instructions.
- 3) Heed all warnings.
- 4) Follow all instructions.
- 5) Do not use this apparatus near water.
- 6) Clean only with dry cloth.
- 7) Do not block any ventilation openings. Install in accordance with the manufacturer's instructions.
- 8) Do not install near any heat sources such as radiators, heat registers, stoves, or other apparatus (including amplifiers) that produce heat.
- 9) Do not defeat the safety purpose of the polarized or grounding-type plug. A polarized plug has two blades with one wider than the other. A grounding type plug has two blades and a third grounding prong. The wide blade or the third prong are provided for your safety. If the provided plug does not fit into your outlet, consult an electrician for replacement of the obsolete outlet.
- 10) Protect the power cord from being walked on or pinched particularly at plugs, convenience receptacles, and the point where they exit from the apparatus.
- 11) Only use attachments/accessories specified by the manufacturer.
- 12) Use only with the cart, stand, tripod, bracket, or table specified by the manufacturer, or sold with the apparatus. When a cart is used, use caution when moving the cart/apparatus combination to avoid injury from tip-over.
- 13) Unplug this apparatus during lightning storms or when unused for long periods of time.
- 14) Refer all servicing to qualified service personnel. Servicing is required when the apparatus has been damaged in any way, such as power-supply cord or plug is damaged, liquid has been spilled or objects have fallen into the apparatus, the apparatus has been exposed to rain or moisture, does not operate normally, or has been dropped.



Additional Safety Information

No naked flame sources, such as lighted candles, should be placed on the apparatus;

Do not use the apparatus in tropical climates.

WARNING: To reduce the risk of fire or electric shock, do not expose this apparatus to rain or moisture.

The apparatus shall not be exposed to dripping or splashing and that no objects filled with liquids, such as vases, shall be placed on the apparatus.

The mains plug is used as the disconnect device and shall remain readily operable.

Il convient de ne pas placer sur l'appareil de sources de flammes nues, telles que des bougies allumées;

L'appareil n'est pas destiné à être utilisé sous un climat tropical.

L'appareil ne doit pas être exposé à des égouttements d'eau ou des éclaboussures et de plus qu'aucun objet rempli de liquide tel que des vases ne doit être placé sur l'appareil.

Lorsque la prise du réseau d'alimentation est utilisée comme dispositif de déconnexion, ce dispositif doit demeurer aisément accessible.

Trademarks: The Nord logo is a trademark of Clavia DMI AB. All other trademarks mentioned in this publication are the properties of their respective holders.

Specifications and appearances are subject to change without notice.

Copyright © Clavia DMI AB



1. INTRODUCTION

THANK YOU!

Thank you for purchasing the Nord Drum 3P. We have designed this musical instrument to be an all-in-one drum synthesizer for drummers, percussionists and producers in search of unique and organic percussive sounds. Much effort has gone into making this instrument as versatile, responsive and straight-forward to use as possible. We hope the Nord Drum 3P will spark your inspiration and add some new flavors to your music making!

TABLE OF CONTENTS

| | | | |
|-----------------------------------|----|---|----|
| 1. INTRODUCTION | 3 | EQ Freq | 10 |
| Thank you! | 3 | EQ Gain | 10 |
| 2. OVERVIEW | 4 | Dist | 10 |
| The Panel | 4 | Type | 10 |
| Dial | 4 | Rvb Amt | 10 |
| Ch Select Buttons | 4 | Dly Amt | 11 |
| Peak/Focus LEDs | 4 | Drum Kit Parameters | 11 |
| Trig/Mono LEDs | 4 | Reverb Parameters | 11 |
| Parameter Buttons | 5 | Color | 11 |
| Lower Param Button | 5 | Type | 11 |
| Shift/Exit Button | 5 | Delay Parameters | 11 |
| Trig/Tap BPM Button | 5 | Rate | 11 |
| Drum Kit select Button | 5 | Feedback | 11 |
| Drum Select Button | 5 | BPM | 11 |
| Drum Kit/Value LED displays | 5 | Tap BPM | 11 |
| Master Level | 5 | Global Settings | 11 |
| 3. USING THE NORD DRUM 3P | 6 | Copy | 11 |
| Channels and Signal Flow | 6 | Paste | 11 |
| Basic Operations | 6 | Swap | 11 |
| Drum Kit Select | 6 | System | 11 |
| About Drums and Drum Kits | 6 | MIDI | 12 |
| Store Kit | 6 | Pad Mode | 12 |
| Memory Protect | 6 | Pad Thres | 12 |
| Drum Select | 6 | Pad Sens | 13 |
| Store Drum | 6 | Init Sound | 13 |
| Pad Follow | 6 | Updating the OS | 13 |
| Mono Group | 7 | 4. MIDI | 14 |
| Edit All Ch | 7 | MIDI operation | 14 |
| Solo Part | 7 | Global and individual MIDI | 14 |
| Lower Param | 7 | Global MIDI Channel | 14 |
| Panic | 7 | Individual MIDI channels | 14 |
| Channel Parameters | 7 | Recording: Global MIDI channel | 14 |
| Noise Parameters | 7 | Recording parameter changes | 14 |
| Resonance | 7 | Recording: Individual MIDI Channels | 14 |
| Flt Type | 7 | Pitch control on Individual MIDI Channels | 14 |
| Freq | 8 | MIDI Controller | 14 |
| Dyn Filter | 8 | Sending A Drum Kit Sys Ex Dump | 14 |
| Decay | 8 | Receive A Drum Kit Sys Ex Dump | 15 |
| Mode | 8 | The Nord Beat App | 15 |
| Tone Parameters | 8 | MIDI CC List | 15 |
| Spectra | 8 | I APPENDIX: CONNECTIONS/ASSEMBLY | 16 |
| Wave | 8 | Audio Connections | 16 |
| Freq | 9 | Headphones | 16 |
| Dyn Filter | 9 | Left and Right Out | 16 |
| Decay | 9 | Kick Connection | 16 |
| Mode | 9 | MIDI Connections | 16 |
| Bend | 9 | MIDI In | 16 |
| Time | 9 | MIDI Out | 16 |
| Pitch | 9 | Power | 16 |
| Sci Pre | 9 | Off/On Switch | 16 |
| Click Parameters | 10 | Attaching the stand holder | 16 |
| Level | 10 | II APPENDIX: NORD DRUM 3 MANAGER | 17 |
| Type | 10 | Get Drum Kit Banks | 17 |
| Mix Parameters | 10 | Send Drum Kit Banks | 17 |
| Noise Lvl | 10 | Get Drum Banks | 17 |
| Tone Lvl | 10 | Send Drum Banks | 17 |
| Ch Level | 10 | III INDEX | 18 |
| Pan | 10 | | |
| EQ and Effects Parameters | 10 | | |

2. OVERVIEW

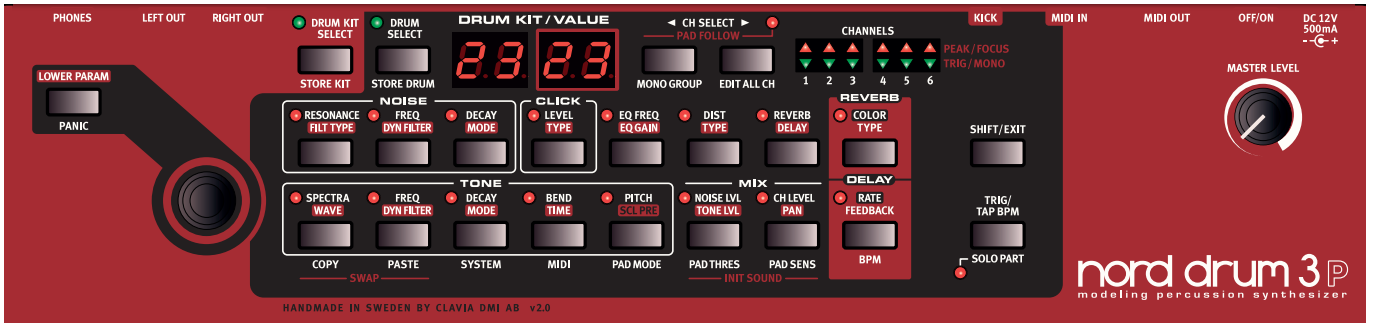

THE PANEL

The Nord Drum 3P user interface is designed to allow for rapid adjustments and quick access to all sound-altering parameters. Below is an overview of the controls found on the Nord Drum 3P panel. Complete descriptions of all features can be found later on in the manual.

- ❗ *At the back of the instrument you will find all necessary jacks for setting up appropriate audio, power, MIDI and trigger connections to your Nord Drum 3P. If unsure, refer to the Appendix on page 14 for instructions on how to perform these connections in a correct and safe way.*



DIAL

The Dial is used to select Drum Kits or Drums, as well as to change the setting of a selected parameter when editing a sound.

The Dial is sensitive to the speed of the turning action. A quick twist to the left or the right can set a parameter to its lowest or highest value.

Certain parameters have a default setting in the middle, between the highest and lowest settings. Bend is one example, with 0 Bend in the middle of the range. When turning the Dial the setting will momentarily stop at the center value.



CH SELECT BUTTONS

The two **CH SELECT** buttons are used to select which Channel is being focused for editing and for adding Channels to a Mono Group. More information about Mono Groups is found on page 7.

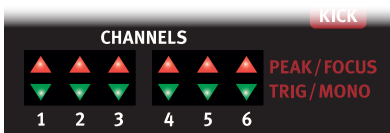

PEAK/FOCUS LEDS

The red **PEAK/FOCUS** LEDs will flash when the pad signal approaches maximum velocity. This indication can be used to make sure that you utilize the full dynamic range of the Nord Drum 3P. Read more about how to adjust the dynamic range and pad sensitivity on page 13.

The Peak/Focus LEDs are also used to indicate which Channel is focused for editing. In Edit All Ch mode (see page 7), all LEDs will be lit.

TRIG/MONO LEDS

The green **TRIG/MONO** LEDs are used to indicate pad activity and flash when a Channel is being triggered by a pad. A LED is lit with a fixed light if its Channel is part of a Mono Group.

PARAMETER BUTTONS

Parameters are accessed with the two rows of parameter buttons. Press any button to access the associated parameter and begin editing a sound. Settings are changed by turning the Dial. The parameter name and value will be shown in the displays.

Read more about all Channel parameters, beginning on page 7.

LOWER PARAM BUTTON

The **LOWER PARAM** button is used, with the Dial, for accessing parameters written on a Parameter button's second row.

SHIFT/EXIT BUTTON

Some buttons provide a secondary function, indicated by the text under the button. These functions are accessed by holding down **SHIFT** while pressing the associated button. The Shift button can also be used to **EXIT** settings menus as well as to abort a Drum Kit Store or Drum Store operation.

TRIG/TAP BPM BUTTON

Use the **TRIG/TAP BPM** button to trigger the sound of the currently selected Channel. This button can also be used to enter a tempo by tapping it when the Delay effect is in BPM mode (see page 11).

DRUM KIT SELECT BUTTON

The **DRUM KIT SELECT** button is used for selecting Drum Kits with the Dial. Read more about Drum Kits on page 6.

DRUM SELECT BUTTON

The **DRUM SELECT** Button is used to select Drum sounds for individual Channels with the Dial. Read more about this and about the factory Drum banks on page 6.

DRUM KIT/VALUE LED DISPLAYS

A **DRUM KIT** is indicated in the displays with the left display indicating the bank and the right display the kit number.

The **VALUE** display mode is enabled as soon as a parameter in the Nord Drum 3P is selected with a parameter button.

MASTER LEVEL

The **MASTER LEVEL** knob sets the overall output level of the Nord Drum 3P. This is not a programmable control.

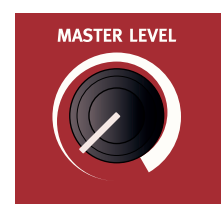
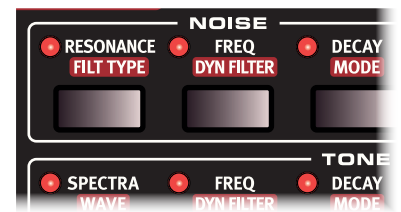

3. USING THE NORD DRUM 3P

CHANNELS AND SIGNAL FLOW

The Nord Drum 3P has six *Channels*, meaning that it can produce six simultaneous sounds. Each Channel has an identical set of parameters. A Drum sound in the Nord Drum 3P is created with a blend of up to three *Parts*: **TONE**, **NOISE** and **CLICK**. Each Part has its individual set of parameters.

The Tone can be described as the tonal “body” of the sound while Noise is a non-pitched addition or building block. The Click is the very first transient, much like the contact sound of a stick hitting a drum or other object. The sum of these parts can be processed with Dist, EQ, Delay and Reverb.

The diagram below shows the signal flow for one Channel on the Nord Drum 3P.

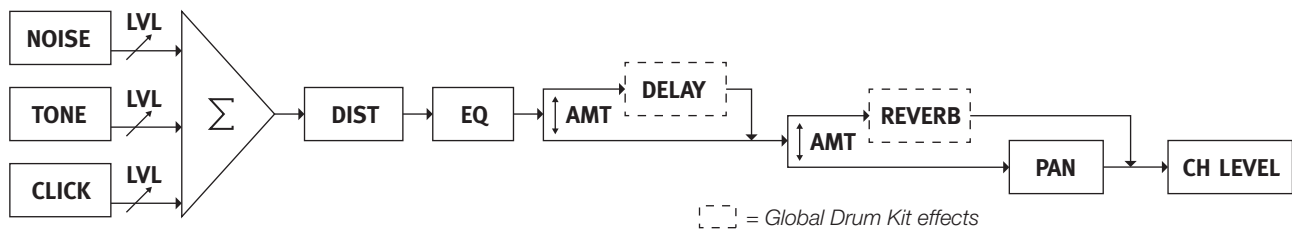

BASIC OPERATIONS

DRUM KIT SELECT



When powering up the Nord Drum 3P it will start in Drum Kit Select mode, which allows for browsing and selecting Drum Kits using the dial.

Press the **DRUM KIT SELECT** button to enter Drum Kit Select mode, which is indicated by its green LED being lit with a fixed light. A Drum Kit is shown in the displays with letters *P-r-d* representing the bank, followed by the Drum Kit number (*1-50*).

ABOUT DRUMS AND DRUM KITS

A Drum Kit represents the basic program format on the Nord Drum 3P and is a container for six Drum sounds, or Channels, in turn accessed by the six pads. Despite its name, a Drum does not necessarily need to sound like a drum but could be any type of sound which can be created on a Nord Drum 3P Channel.

STORE KIT

Use Store Kit to save any changes made to a Drum Kit to the Nord Drum 3P memory. When **STORE KIT** is pressed the displays will flash and the dial can be used to select the location to which you want to store the Drum Kit.

MEMORY PROTECT

When the Nord Drum 3P is shipped, Memory Protect is set to On in order to avoid accidentally overwriting Drum Kits. Turn Memory Protect Off (*P-r.OF*) in the System settings to enable storing Drum Kits on the Nord Drum 3P.

DRUM SELECT

The Nord Drum 3P has ten categorized Drum banks, each containing a selection of read-only factory sounds. In addition, there are eight uncategorized banks allowing for further storage of up to four hundred user Drum sounds.

Press **DRUM SELECT** to access the Drum banks and use the Dial to browse through them. The selected sound will replace the content of the currently active Channel.

| Value | Description |
|--------------------|------------------|
| <i>bd</i> | Bass drums |
| <i>Sn</i> | Snare drums |
| <i>to</i> | Toms |
| <i>HH</i> | Hi-hats |
| <i>CY</i> | Cymbals |
| <i>Pc</i> | Percussion |
| <i>bE</i> | Bells |
| <i>tU</i> | Tuned percussion |
| <i>EF</i> | Effects |
| <i>U 1-8, 1-50</i> | User banks |

STORE DRUM

Press **STORE DRUM** to store the contents of the currently active Channel as a user Drum sound. Use the dial to select a destination for the store operation, which could be any user location within the pre-defined categories or a location within the dedicated user banks.

💡 Pressing **SHIFT** while turning the dial allows for quick navigation between the Drum categories and user banks.

PAD FOLLOW



Press the two **CH SELECT** buttons simultaneously to enter **PAD FOLLOW** mode, indicated by the Pad Follow LED being lit. With Pad Follow active, striking any pad at high velocity will automatically make its Channel focused for editing, indicated by its **PEAK/FOCUS** LED.

MONO GROUP

The Mono Group feature allows you to mute the output of a Channel by playing on any other Channel in the Mono Group, making a group of Channels behave as one monophonic instrument. This can be used to silence an open hihat sound on one Channel, by playing a closed hihat sound on another Channel that is in the Mono Group.

Press the **MONO GROUP** button to make the currently selected Channel part of the Mono Group. Select another Channel with the CH Select buttons and press Mono Group again to add this to the Mono Group.

The Channels in the Mono Group will be indicated by steady lit green LEDs. The Mono Group selection will be saved with the Drum Kit.

☀ Hold **SHIFT** and the **MONO GROUP** button for one second to clear an entire Mono Group if there is a selection, or to add all Channels to a group if none is selected.

EDIT ALL CH

The **EDIT ALL CH** feature is used to make simultaneous parameter edits on all six Channels. This is useful for setting up any parameters that should be the same for all Channels and provides a quick method for applying Reverb, Delay or any other effect to the entire Drum Kit. When activated, all Peak/Focus LEDs will be lit with a fixed light.

When editing the Scale Preset parameter for the Tone part, Edit All Ch will automatically be active throughout the operation. Read more about this on page 9.

ⓘ The Edit All Ch state is not saved when storing a Drum Kit.

SOLO PART



Activate **SOLO PART** to only hear the Part (Noise, Tone or Click) that is currently being edited. In addition, the Channel in focus will be soloed in regard to incoming MIDI notes.

LOWER PARAM



To edit a Lower Parameter - written on the second row above a parameter button and indicated by a red label - hold down the **LOWER PARAM** button while operating the Dial. Another method for accessing the Lower Parameter is to keep the associated button pressed down while turning the Dial.

PANIC

Use **PANIC** to immediately terminate sound on all Channels. This can be useful if external MIDI input causes notes to hang, or if you during a live performance quickly want to turn off all currently playing sound.

CHANNEL PARAMETERS

NOISE PARAMETERS



The **NOISE** Part consists of a white noise generator followed by a dynamic multimode filter which shapes the noise spectra. The filter cutoff frequency is controlled by a velocity modulated dynamic filter envelope.

RESONANCE

RESONANCE is used to emphasize frequencies around the filter cutoff frequency. This can be perceived as making the sound thinner or a bit "nasal".

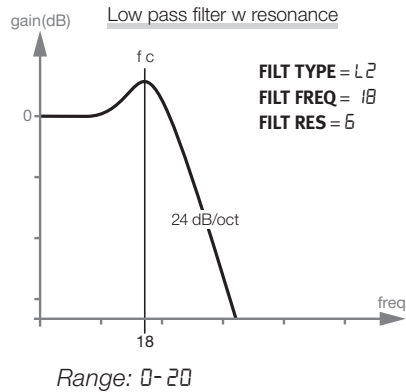

FILT TYPE

There are seven filter types - **FILT TYPE** - to choose from: low pass, high pass and band pass with different slopes. The low pass and high pass can have a 12 or 24 dB/octave slope, with an additional 24dB/octave High Cut version of the high pass filter that also dampens the high frequencies a bit. The band pass can be set to 6 or 12 dB/octave.

A low pass filter dampens the treble, making the sound duller.

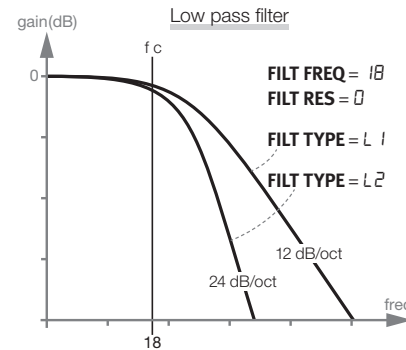

High pass cuts the bass frequencies, making the sound brighter.

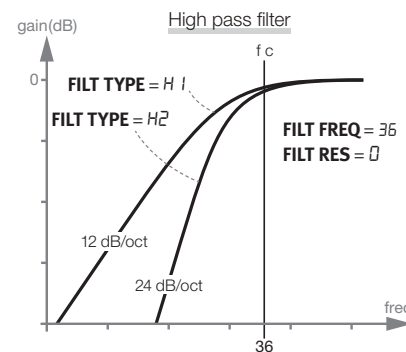

Band pass dampens frequencies from both the treble and the bass.

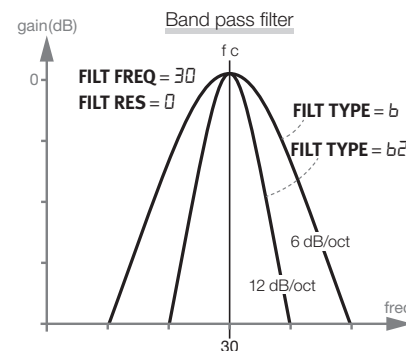

The slope describes how steep the filter will be at the cut off frequency.

Range: L 1 (Low Pass 12 dB), L2 (Low Pass 24 dB), b 1 (Band Pass 6 dB), b2 (Band Pass 12 dB), H 1 (High Pass 12 dB), H2 (High Pass 24 dB), H3 (High Pass high cut)

FREQ

The Filter **FREQ** is the cutoff frequency where the selected filter will begin to influence the noise. The actual sound that is produced depends on the filter type.

Range: 0 - 50

DYN FILTER

DYN FILTER sets the amount of dynamic velocity modulation on the noise filter envelope. This parameter is bipolar, a positive setting will open the filter and a negative setting will close the filter.

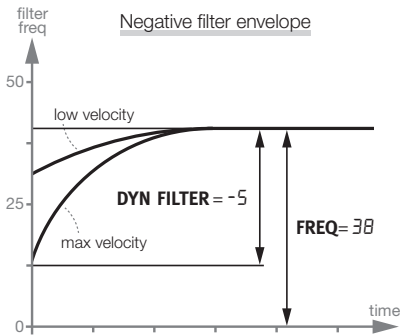
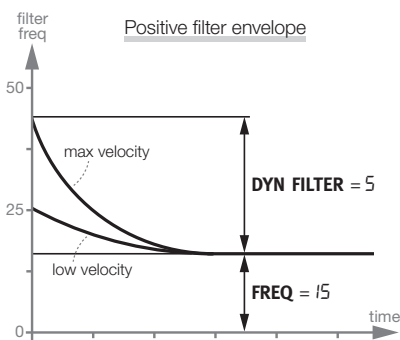

Range: -9 to 9

DECAY

The **DECAY** parameter defines the time it takes for the Noise level to drop to zero after having been triggered. The higher the value, the longer the noise.

Range: 0-50

MODE

Decay **MODE** determines the decay profile of the Decay envelope. In *Exponential* (E 1-E3) mode the noise will fade quickly in the beginning, and gradually decrease with a smaller amount per time interval. *Linear* mode gives an entirely linear Decay envelope, and *Gate* mode maintains a full noise level all the way up until the Decay time has been reached.

Dynamic Decay mode:

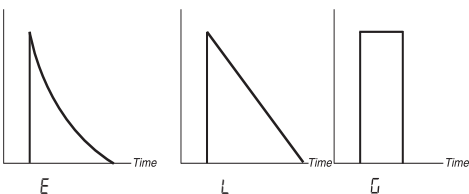

Turning past the E, L and G modes a number will appear on the display. This number indicates the value of the Decay at zero velocity, allowing for the Decay length to respond dynamically to the force with which the pad is triggered. The diagrams below show how the Decay and Dynamic Decay mode parameters interact at different settings.

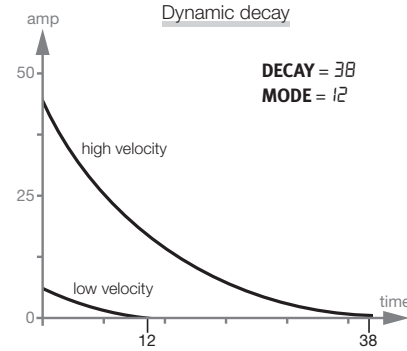
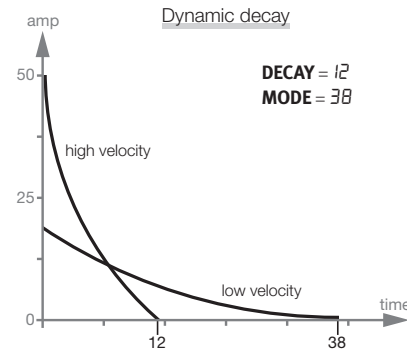

Range: E, E2, E3 (Exponential), L (Linear), G (Gate), 0-50

TONE PARAMETERS



The **TONE** part can be thought of as the “body” of the sound and its associated parameters allow a large number of different sounds to be achieved.

The **WAVE** parameter provides a selection of synthesis models, specifically designed to provide a wide range of drum sounds. The **SPECTRA** and **FREQ** parameters change the harmonic content of the Waves. In addition, Freq can be dynamically controlled by a velocity modulated decay envelope, using the **DYN FILTER** parameter.

SPECTRA

The **SPECTRA** parameter allows for stretching or tuning the spectral components. As an example, the drumhead models (d1 - d9 Waves) can have the head tuned separate from the body resonance, determined by the **PITCH** parameter. When FM is used, the Spectra parameter will set the modulator frequency.

Range: 0 - 99

WAVE

The Nord Drum 3P features several different synthesis models referred to as Waves, representing a range of different characters and areas of application. Some Waves will give the Tone part a distinctive pitch, and others will provide a more non-pitched character.

| Wave | Description | Spectra |
|----------|---|-----------------------------------|
| A 1 | Analog style sine wave | - |
| A2 | Analog style triangle wave | Detune 2 nd triangle |
| A3 | Analog style sawtooth wave | Detune 2 nd sawtooth |
| A4 | Analog style square wave | Detune 2 nd square |
| A5 | Highpass filtered square wave | Detune 2 nd square |
| A6 | Analog style pulse wave | Initial pulse width |
| E 1 | T-bridge oscillator | - |
| E2 | T-bridge oscillator | Detune 2 nd oscillator |
| F 1 - F4 | FM algorithms. | Detune operator |
| H 1 - H6 | Harmonic resonance modelling. | Resonance center |
| d 1 - d7 | Drum head resonance modelling. | Resonance center |
| P 1 - P4 | Resonance modelling of tuned percussion: marimba, vibraphone etc. | Resonance center |
| C 1 - C3 | Cymbals. | Cymbal tune & filter |
| r 1 - r2 | Ring mod oscillators | Detune modulator |

FREQ

The initial frequency, defining the timbre of the tone, is set with the **FREQ** parameter. A value of 0 produces less harmonics, and gives the Dyn Filter amount and striking force a greater influence on the Wave. A value of 50 will produce the maximum harmonic content, leaving little to be controlled by the Dyn Filter parameter.

The analog style waveforms are low pass filtered, the other Waves will have their harmonic content changed.

Freq controls the FM amount if a FM Wave is selected.

- ❗ In T-bridge oscillator mode, Freq sets the mix between the two oscillators.
- ❗ Freq is not available if the A 1 (sine) waveform is selected.

Range: 0 - 50

DYN FILTER

Sets the amount of the envelope that changes the Freq together with the velocity.

- ❗ Dyn Filter is not available if the A 1 (sine) waveform is selected.

Range: 0 - 49

DECAY

The **DECAY** parameter sets the length of the Tone. The higher the value, the longer the sound.

Range: 0 - 50

MODE

Decay **MODE** determines the behaviour of the decay parameter, and controls whether the Tone sound should decay exponentially or linearly. There is also a “punch” setting, which uses the exponential decay mode but also adds a short, velocity controlled attack portion to the Wave.

Dynamic Decay mode:

Turning past the E, L and P modes a number will appear on the display. This number indicates the value of the Decay at zero velocity, allowing for the Decay length to respond dynamically to the force with which the pad is triggered. Refer to the Noise Decay Mode section on page 8 for examples on how Decay and Dynamic Decay mode parameters interact at different settings.

Range: E 1-E3 (Exponential), L (Linear), P (Punch), 0-50

BEND

The velocity sensitive **BEND** parameter sets the pitch bend of the Tone. The Bend has two directions with positive values bending *down* and negative values bending *up* to the Tone pitch.

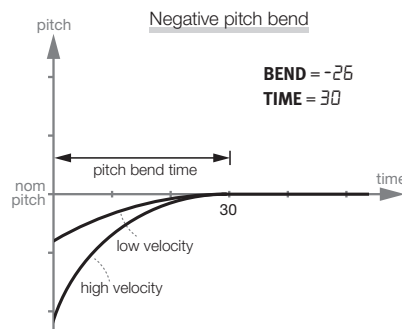
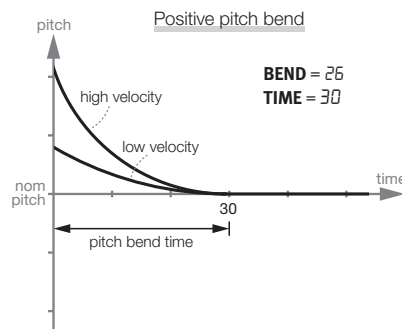

Range: -9 - 50

TIME

The bend **TIME** parameter sets the duration of the pitch bend, determining how quickly the Tone pitch is reached.

Range: 0 - 50

PITCH

PITCH sets the basic pitch of the Tone, in semitones. The pitch is shown in the Display as MIDI Note Numbers. A setting of 69.0 equals A = 440 Hz.

Range: 0.0 - 127.5

SCL PRE

The scale presets - **SCL PRE** - can be used to quickly set up certain

pitch relationships between the six pads, using Edit All mode. Enter **EDIT ALL** mode and use the SCL Pre function to select a scale with the dial.

The pitches will begin at the set pitch on the lowest Channel and increase with a factor determined by the selected scale.

If a Scale has been used to set a pitch relationship, you can change the pitch of one Channel without breaking the pitch relationship. This will move all the other pitches until one of the pitches reaches the maximum, or minimum pitch ("0" or "127.5").

| SCL value | Description |
|----------------|------------------------|
| h 1-7 | Harmonies/chord scales |
| P 1-2 | Pentatonic scales |
| H 1-5 | Hang tunings |
| A _u | Hexatonic, augmented |
| bL | Hexatonic, blues |

SCL Pre is not a parameter as such and will not be stored as one. It will act as a macro on the pitch settings of the selected Channels.

CLICK PARAMETERS



The **CLICK** Part adds a sharp transient at the very beginning of the sound, useful for giving a sense of stick attack and sonic energy at the onset of a Drum hit.

LEVEL

The amplitude of the Click is set with the **LEVEL** parameter.

Range: 0 - 50

TYPE

TYPE provides a selection of different click types, each with its own character.

| Click | Description |
|-------|--|
| n 1-3 | Noise waveforms with different characters. |
| P 1-3 | Short pulses. |
| H 1-3 | High pass filtered, short pulses. |
| Ɔ 1-3 | Clicks with a pitched and somewhat "chirpy" character. |

Range: n 1-3, P 1-3, H 1-3, Ɔ 1-3

MIX PARAMETERS

NOISE LVL

NOISE LVL sets the volume of the Noise Part.

Range: 0 - 50



TONE LVL

TONE LVL sets the volume of the Tone Part.

Range: 0 - 50

CH LEVEL

CH LEVEL sets the volume of the Channel being edited.

Range: 0 - 50

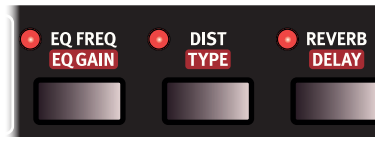

PAN

The **PAN** parameter sets the position of the Channel in the stereo panorama from left to right. The Ɔ setting indicates that the Channel is centered.

Range: L9 - Ɔ - r9

EQ AND EFFECTS PARAMETERS

EQ FREQ

Every Channel has a parametric equalizer for boosting or cutting within a frequency band, set by the **EQ FREQ** parameter. The equalizer has a fixed bandwidth (Q value).

i If the EQ Gain parameter is set to 0, changing this parameter will have no effect.

Range: 0-50

EQ GAIN

Use the **EQ GAIN** control to boost or cut with up to +/- 24 dB at the selected EQ frequency.

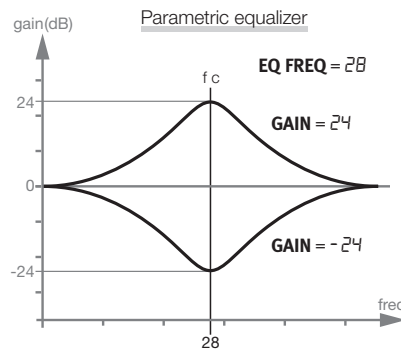

Range: -9 - 9

DIST

The **DIST** parameter adds distortion to the sound of the selected Channel.

Range: 0 - 50

TYPE

There are three distortion types. The tube amplifier style overdrive (*dr*) applies a classic distortion effect, while the sample rate reduction (*SR*) gives a retro lo-fi character. The Ring modulation (*rn*) modulates the output with a sine wave that can be set to different frequencies creating anything from a subtle vibrato to a rich belltone.

Range: dr, SR, rn

RVB AMT

The **RVB AMT** parameter sets the level of the wet Reverb signal, in rela-

tion to the dry unaffected signal. At 25 the dry/wet balance is 50/50 and at 50 only the wet signal will be heard.

💡 The **EDIT ALL** mode allows for quick application of Reverb to the entire Drum Kit.

Range: 0 - 50

DLY AMT

The **DLY AMT** parameter sets the level of the wet Delay signal, in relation to the dry unaffected signal.

Range: 0 - 50

DRUM KIT PARAMETERS

REVERB PARAMETERS

COLOR

The **COLOR** parameter controls the balance between low and high frequency content in the Reverb signal. Turning the Color parameter down towards -9 will filter out *high* frequencies from the incoming signal. Turning the Color parameter up towards 9 will filter out *low* frequencies. At 0 the incoming signal is not filtered.

Range: -9 - 9

TYPE

Reverb **TYPE** determines the character and size of the Reverb effect. There is a number of different types to choose from, ranging from small to very large reverb sizes.

Range: *T* (Tiled Room), *r1* - *r2*, (Room 1-2), *P1* - *P4*, (Plate 1-4), *St* (Stage), *hA* (Hall)

DELAY PARAMETERS

RATE

Delay **RATE** controls the time between the taps generated by the Delay effect.

Range: 0 - 99 (1.15 s - 10 ms)

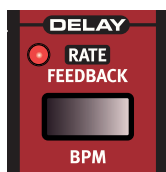

FEEDBACK

The **FEEDBACK** parameter determines the number of taps present in the Delay signal. At its minimum value only one tap will be heard, while at its maximum value giving an almost infinite amount of taps.

Range: 0-20

BPM

Delay Rate can also be set using the **BPM** (Beats Per Minute) parameter. In BPM mode both displays will be used to show the tempo. The Delay Feedback parameter can still be accessed using the Lower Parameter button.

For values above 179 (quarter notes per minute) symbols will appear indicating that the Delay is being set to eighth (one horizontal bar, $\bar{_}$) or sixteenth notes (two horizontal bars, $\bar{_}$) respectively. For values above sixteenth notes in 300 BPM, the display will revert to showing the Rate as a time value instead.

Range: 60-179, $\bar{_}$ 90- $\bar{_}$ 179, $\bar{_}$ 90- $\bar{_}$ 300, 0.050-0.001 (s)

TAP BPM

When in BPM mode, the tempo can be entered by tapping the **TRIG/TAP BPM** button. A minimum of four taps are required for defining the tempo, indicated in the display as below (tapping 120 BPM in this example):

Tap 1: $\bar{_}$ 000, Tap 2: $\bar{_}$ 00. Tap 3: $\bar{_}$ 0, Tap 4: 120

GLOBAL SETTINGS

The lower button row has an additional set of functions that are accessed by holding **SHIFT** while pressing the corresponding button. Some of these represent immediate actions (Copy, Paste, Swap and Init Sound). The rest are global settings and features.

Certain settings have more than one set of functions/parameters. These are accessed by pressing repeatedly on the button. Use **EXIT** to return from any of the settings menus.

💡 The settings will remain intact after the unit has been turned off with one exception: MIDI Local will revert to On when the unit is turned on.

COPY

This function allows you to **COPY** all the settings of the selected Channel. The copy can be pasted to another Channel in the same Drum Kit or to a Channel in another Drum Kit by using paste. The copied settings will remain in a "clipboard" until you perform another copy or turn the unit off.

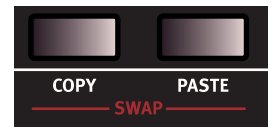

PASTE

After you have copied a Channel, and selected another Drum Kit and/or Channel as a destination, use this function to **PASTE** the settings. The copied settings can be pasted to several destinations, by repeating the Paste command.

❗ When in Edit All Ch mode, the copy will be pasted to all six Channels.

SWAP

Use the **SWAP** operation in order to have two Channels switch sounds with each other:

- ① Select one of the two Channels using the **CH SELECT** buttons.
- ② Press **COPY**.
- ③ Select the other Channel.
- ④ Press **SHIFT** and hold down the two **SWAP** buttons. The display will read $\bar{_}$ RP, indicating that the two sounds have been swapped.

SYSTEM

Pr - Memory Protect: When the Nord Drum 3P is shipped, Memory Protect is set to $\bar{_}$ n in order to avoid any accidental overwriting of Drum Kits. Set Memory Protect $\bar{_}$ F (Off) to enable storing Drum Kits on the Nord Drum 3P.

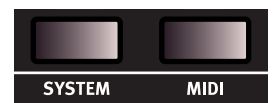

PL - Pad Layout: *PL 1-4* represent four different layouts for how the Nord Drum 3P Channels 1 to 6 are assigned to the six pads.

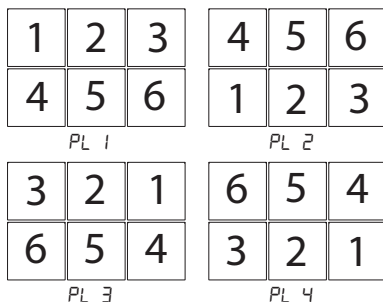

MIDI

There are several MIDI related settings for the Nord Drum 3P. Refer to the MIDI chapter beginning on page 12 for examples on how to use MIDI with the Nord Drum 3P.

Lo - Local Control On/Off is indicated as *Lo.On* or *Lo.Off*. Local Control Off disconnects the internal engine from the pads and panel. Try the Off setting if you use the Nord Drum 3P in a situation where a sequencer is echoing back notes and data.

⚠ *If Local is Off and MIDI is not routed back to the Nord Drum 3P, the controls on the panel will be inoperable.*

Range: *Lo.On*, *Lo.Off*

GL - MIDI Channel: The Global MIDI Channel is used if you want to transmit and receive notes and parameter changes on one MIDI Channel.

Range: *GL.1 - GL.16*, *GL.Off*

Ch - MIDI Channel: Use the individual MIDI Channels for addressing the Nord Drum 3P Channels separately.

Range: *Ch.1 - Ch.16*, *Ch.Off*

nt - MIDI Note: Each of the six Channels can be assigned to respond to an incoming MIDI note. When the Nord Drum 3P is shipped from the factory, Channels 1 to 6 are assigned to MIDI note numbers: 60, 62, 64, 65, 67 and 69.

Range: *n.0 - i27*

PC - Program Change can be set to Off (*Off*), Send only (*S*), Receive only (*r*) and to both Send and Receive (*Sr*). Set this to receive if you want to change the programs on the Nord Drum 3P from a MIDI controller or a sequencer.

Range: *PC.Off*, *PC.S*, *PC.r*, *PC.Sr*

CC - Control Change can be set to Off (*Off*), Send only (*S*), Receive only (*r*) and to both Send and Receive (*Sr*). Set this to receive if you want to change parameters on the Nord Drum 3P from a MIDI controller or a sequencer.

Range: *CC.Off*, *CC.S*, *CC.r*, *CC.Sr*

Send Dump - Send allows you to send a dump of the current Drum Kit from the Nord Drum 3P as MIDI Sys Ex data. Use this function to create backups of individual Drum Kits or for sharing with other Nord Drum 3P users. Start the transmission by pressing **DRUM KIT SELECT**.

ⓘ *Any edits made to the currently selected Drum Kit will be present in the sent data.*

PAD MODE



Ty - Pad Mode Type: The Pad Mode type parameter can be set to *LY.St* for playing with *sticks*, or to *LY.HR* for playing with *hands*. Parameters corresponding to different trigger types are available when a trigger is connected to the Kick input.

Range, Pads: *LY.St - LY.HR*, Kick: *LY.r0 - LY.YR*

Dy - Dynamics: There are six different dynamic response curves that can be individually applied to each of the channels.

| Dyn | Description |
|-----------------|---|
| <i>dy.L 1</i> | This curve has a <i>linear</i> correspondence between velocity and output level. |
| <i>dy.L 1-3</i> | The <i>Logarithmic</i> curves offer a compressed dynamic response. |
| <i>dy.O 1-2</i> | The <i>Offset Level</i> curves has little dynamic response, useful when you want even levels. |

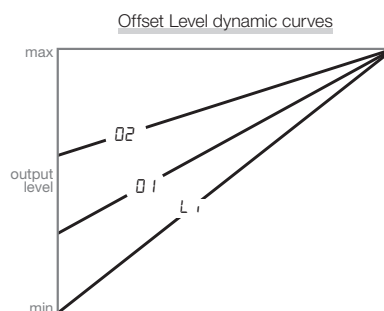
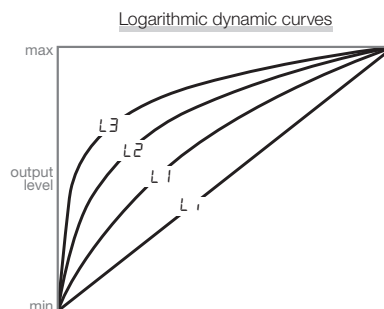

Pad Mode with Kick pedal attached

Pad mode settings for the **KICK** input can only be accessed and modified when a kick pedal or trigger is attached. Press the **left CH SELECT** button to access the Kick specific settings. Only the LED for Channel 1 will be lit in this state.

To return to the Pad Mode options for the pads press the **right CH SELECT** button, causing all six Channel LEDs to light up. The values will be stored in the Nord Drum 3P even after disconnecting the Kick pedal or turning off the machine.

PAD THRES

Use **PAD THRES** to make sure that pads do not accidentally trigger other Channels. If striking a pad activates other sounds than that of its associated Channel, raise the threshold value. On the other hand, if striking a pad does not activate any sound at all the threshold value should be lowered.

Pad Thres with Kick pedal attached

If a kick pedal, or any other trigger type has been connected to the **KICK**

input, the Pad Thres value is set separately for the six Nord Drum 3P pads and for the connected trigger. To set Pad Thres for the connected trigger press the *left* **CH SELECT** button. Only the LED for Channel 1 will be lit in this state.

To return to adjusting Pad Thres for the pads press the *right* **CH SELECT** button, causing all six Channel LEDs to light up. The separate values will be stored in the Nord Drum 3P even after disconnecting the Kick pedal or turning off the machine.

Range: 1 - 20

PAD SENS

PAD SENS is used for tuning the dynamic response of the Nord Drum 3P so that the generated sound gives a proper representation of the velocity with which the pads are being played.

The Input **TRIG** and **PEAK** LEDs provide information on the signals generated by the pads. The green LED will indicate that a trigger signal is received. The red LED will blink quickly when the trigger signal is 3 dB below the maximum and it will be lit up in a longer duration when the maximum level is being triggered.

Adjust the Pad Sens parameter to make sure that only your hardest strike lights up the red LED in its longer duration on the Input Trig Level LEDs.

⚠ *The red LEDs do not indicate overload or distortion in the audio signal path of the Nord Drum 3P.*

Pad Sens with Kick pedal attached:

If a kick pedal, or any other trigger type is attached to the **KICK** input, the Pad Sens value is set separately for the six Nord Drum 3P pads and for the connected trigger. To set Pad Sens for the connected trigger, press the *left* **CH SELECT** button. Only the LED for Channel 1 will be lit in this state. To adjust Pad Sens for the pads press the *right* **CH SELECT** button, causing all six Channel LEDs to light up. The separate values will be stored in the Nord Drum 3P even after disconnecting the Kick pedal or turning off the machine.

Range: 1 - 20

INIT SOUND

Press **SHIFT** and hold down the two **INIT SOUND** buttons to reset a Channel to default values. This provides a good starting point for creating sounds from scratch.

UPDATING THE OS

The version of the installed Operating System (OS) is shown in the display when you turn on the Nord Drum 3P.

Updating is done from a Windows or Mac computer with a connected MIDI interface. The Update Utility application is available for download from www.nordkeyboards.com.

The Update Utility is available for Windows or Mac OSX computers, make sure you use the one that matches your computer system.

You need a MIDI interface attached to the computer in order to update the Nord Drum 3P.

- ① Connect the MIDI In and the MIDI Out from the Nord Drum 3P to the MIDI Out and MIDI In on the MIDI interface.
- ② Double click on the Update utility icon to run the Update application. *The Windows version of the utility is a zipped archive when you download it from the website. This archive has to be expanded with an application like WinRAR before the utility can be executed.*

- ③ Select the MIDI interface and ports you wish to use for the operation and press OK.

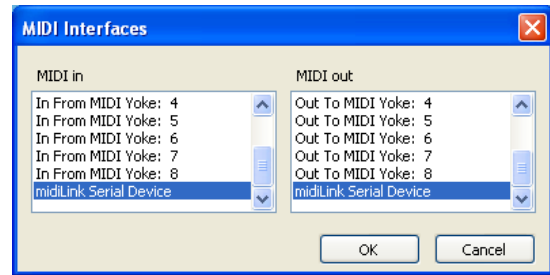

The Update Utility will display the currently installed OS version.



- ④ Click on the Update button to transfer the new OS to the unit.
- ⑤ It will take a moment to transfer the operating system. Do not disconnect the MIDI cables or turn off the Nord Drum 3P during this time. When the unit has been successfully updated, a message will appear in the Update Utility.

💡 *Press **SHIFT** and **DRUM KIT SELECT** while powering the unit up to start the Nord Drum 3P in Update Ready Mode, without booting from the currently installed Operating System.*

Make sure to regularly visit the www.nordkeyboards.com website for OS updates, artist Drum Kit banks and other news concerning the Nord Drum 3P.

4. MIDI

MIDI OPERATION

GLOBAL AND INDIVIDUAL MIDI

There are two methods of operation when using the Nord Drum 3P in a MIDI setup: Using the Global Channel or the individual MIDI Channels. These methods differ in flexibility and in what can be achieved.

Both methods make it possible to record, and to play back MIDI notes and parameter changes. The pads generate MIDI Notes when played and any edits made from the Nord Drum 3P panel, will be transmitted as MIDI Control Change messages.

GLOBAL MIDI CHANNEL

When the Global MIDI Channel is used all MIDI notes and Control Change messages will be transmitted and received on a single MIDI channel.

INDIVIDUAL MIDI CHANNELS

By using the individual MIDI Channels for the Nord Drum 3P all parameters on all Nord Drum 3P Channels can be controlled.

RECORDING: GLOBAL MIDI CHANNEL

- 1 Connect the Nord Drum 3P MIDI In and Out to a computer/MIDI interface/sequencer.
- 2 Set the sequencer track to all Channels or MIDI Channel 10, which is the default Global MIDI channel for the Nord Drum 3P.
- 3 Play the Nord Drum 3P and record the performance. The individual MIDI Notes of the Nord Drum 3P channels will be transmitted to the sequencer on the Global Channel.
- 4 If the sequencer is set to echo back incoming MIDI data, this can cause double triggered notes and flams. If this happens, either turn echoing off or set MIDI Local to Off on the Nord Drum 3P.

RECORDING PARAMETER CHANGES

There are more parameters in the Nord Drum 3P channels than there are available MIDI Control Change numbers. The Channel Select buttons on the panel will therefore be used to set the transmitting and receiving Nord Drum 3P channel focus of the CC messages. This allows you to record and receive parameter changes on the Global MIDI Channel.

As an example, the Noise Filter Frequency control is mapped to CC number 14. This CC number is the same for all the channels in the Nord Drum 3P. When you press the right Channel Select button three times to select channel 4 in the Nord Drum 3P, this transmits CC 70, value 71 ("channel 4 is now set to transmit/receive MIDI") on the Global MIDI Channel.

Press the Noise Filter button and use the Dial to change the filter setting. This will transmit CC 14 with values that correspond to the settings. When the recorded track is played back, the Nord Drum 3P will respond to these MIDI Messages and change the noise filter, on that channel.

- ❗ *If you want to make parameter changes on more than one Nord Drum 3P channel at the same time, using overdub recording techniques, the Individual MIDI Channels approach would be more suitable.*

RECORDING: INDIVIDUAL MIDI CHANNELS

Use the Individual MIDI Channels when you need to control parameters on more than one Nord Drum 3P channel at a time. The Global MIDI Channel can still be used for the notes if you wish to keep those on one track in the sequencer.

- 1 Program or record the notes on one track in the sequencer, a track set to the Global MIDI Channel.
- 2 Create a new track that is set to the Individual MIDI channel of the Nord Drum 3P channel you wish to control.
- 3 Play back the notes you recorded and at the same time, record any parameter changes by making these on the Nord Drum 3P panel, or from other MIDI devices set to control the Nord Drum 3P, on the new track. You can record overdubs on this control track if you wish to change several parameters.

PITCH CONTROL ON INDIVIDUAL MIDI CHANNELS

If you record notes on a track set to an Individual MIDI Channel, you can control the Tone pitch of the Nord Drum 3P channel with the actual MIDI Note Numbers.

- 💡 *Set the Tone Pitch parameter to 60 if you want to match the Tone pitch to the scale on a keyboard.*

MIDI CONTROLLER

A MIDI Fader box or Controller can be used to have full control of all parameters on all Nord Drum 3P channels. Such a setup would use the individual MIDI Channels. Make sure that each Nord Drum 3P Channel is set to an exclusive MIDI Channel.

Assign the MIDI Control Change number to the knobs and buttons on the MIDI unit. Make sure that the transmitting MIDI channel of the MIDI unit always matches the individual MIDI Channels set in the Nord Drum 3P.

SENDING A DRUM KIT SYS EX DUMP

By using MIDI Sys Ex dumps, you can store the currently active Drum Kit on a computer or sequencer. The memory dump can be recorded to a sequencer or one of the many, free MIDI applications that can receive, save and transmit MIDI data. Windows users can do this with MIDI Ox (www.midiox.com), Mac OSX users can use the Sys Ex Librarian from Snoize Productions (www.snoize.com).

- 1 Make sure that the receiver is ready to receive and that MIDI Out from the Nord Drum 3P is connected to MIDI In on a MIDI interface connected to the computer.
- 2 Press **SHIFT** and the **MIDI** button repeatedly until *5Erd* is shown in the display.
- 3 Start the transmission by pressing the **DRUM KIT SELECT** button. When the transmission is complete, "*δδδδ*" will be shown briefly in

the LED display.

- 4 Check the receiving application and make sure that the data is there. Give the file a meaningful name and save it to a suitable location on the hard drive.
- i** *Transmitting data will not affect the memory content in the Nord Drum 3P.*

RECEIVE A DRUM KIT SYS EX DUMP

A Drum Kit can be sent to the Nord Drum 3P in Sys Ex format, from within a sequencer or similar. When a Drum Kit is received by the Nord Drum 3P it will replace the contents of the currently loaded kit. A manual Store operation is required for saving the kit to the Nord Drum 3P memory.

- 1 Make sure that your sequencer or MIDI application is ready to transmit a Sys Ex package and that MIDI Out from the MIDI interface on the computer is connected to MIDI In on the Nord Drum 3P.
- 2 Start the transmission on the MIDI application.
- 3 The contents of the currently selected Drum Kit will now have been replaced with the contents of the Sys Ex package.
- 4 Optionally Store the Drum Kit to a memory location on your Nord Drum 3P.

💡 *To transfer entire Drum Kit banks to or from the Nord Drum 3P use the Nord Drum 3P Manager application. See page 15 for details.*

THE NORD BEAT APP

Nord Beat is a free sequencer application for the iPad, designed for use with the Nord Drum 3P. Nord Beat has a classic step sequencer interface with an easy to use grid for programming patterns and combining patterns to songs. Download the application through the App Store. You need an iPad compatible MIDI Interface to connect MIDI to and from the Nord Drum 3P.

- i** *Use Global MIDI Channel 10 on the Nord Drum 3P and set the individual MIDI channels to "Off".*



MIDI CC LIST

| MIDI CC | Parameter |
|---------|------------------------|
| 0 | Bank Select MSB |
| 7 | Level |
| 10 | Pan |
| 12 | Reverb Type |
| 13 | Reverb Color |
| 14 | Noise Filter Frequency |
| 15 | Noise Filter Type |
| 16 | Noise Dyn Filter |
| 17 | Noise Filter Resonance |
| 18 | Noise Level |
| 19 | Tone Level |
| 20 | Noise Decay Mode |
| 21 | Noise Decay |
| 23 | Dist Amount |
| 24 | Dist Type |
| 25 | EQ Frequency |
| 26 | EQ Gain |
| 30 | Tone Spectra |
| 31 | Tone Pitch MSB |
| 32 | Bank Select LSB |
| 44 | Delay Rate |
| 45 | Delay Feedback |
| 46 | Tone Wave |
| 47 | Delay Amount |
| 48 | Reverb Amount |
| 49 | Tone Decay Mode |
| 50 | Tone Decay |
| 52 | Tone Freq |
| 53 | Tone Dyn Filter |
| 54 | Tone Bend Amount |
| 55 | Tone Bend Time |
| 56 | Click Level |
| 57 | Click Type |
| 59 | Mono Group |
| 63 | Tone Pitch LSB |
| 70 | Channel Select |

I APPENDIX: CONNECTIONS/ASSEMBLY

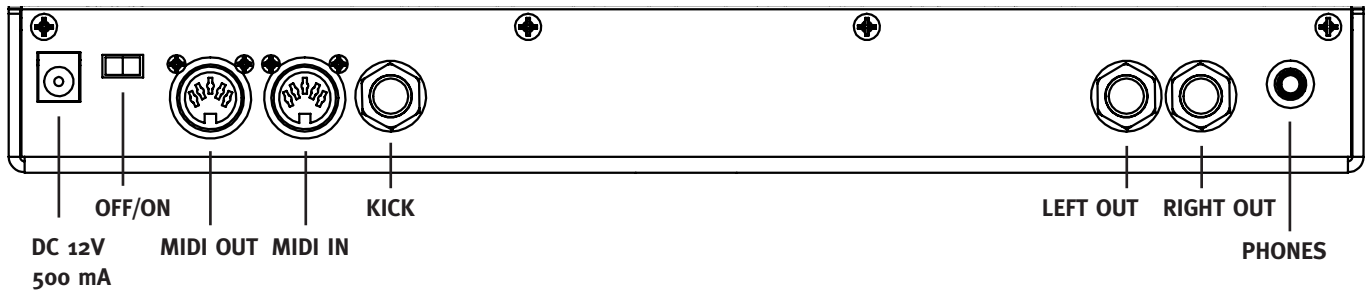

AUDIO CONNECTIONS

General guide on audio connections: Before turning on your amplifier, make all audio connections. Always turn on the amplifier last, and when shutting down, always turn off your amplifier or active speakers first.

HEADPHONES

1/8 inch stereo headphone jack.

LEFT AND RIGHT OUT

1/4 inch unbalanced line level outputs for amplifier or recording equipment. The Nord Drum 3P is a stereo instrument with separate signal paths for left and right audio channels.

⚠ *Using your Nord Drum 3P at a high volume can damage your hearing.*

KICK CONNECTION

1/4 inch unbalanced line level input for Kick trigger pedals or pads. The Nord Drum 3P works with a wide range of triggers and trigger signals. Refer to page 12 for information on how to set the dynamic response and sensitivity of the attached trigger.

❗ *The attached Kick trigger is always paired with Channel 1.*

MIDI CONNECTIONS

MIDI IN

The MIDI In connection is used for receiving MIDI data sent from external devices such as controllers, sequencers or computers. The MIDI In is also used when you update the unit with new operating systems.

MIDI OUT

Connect the MIDI Output to a computer or sequencer to record what is being played on the pads. The performance will be transmitted as MIDI notes, which also can be used to trigger other MIDI units.

MIDI Output is also used with the Program Dump feature to transfer the settings of the programs in the Nord Drum 3P via MIDI.

POWER

Connect the Nord Drum 3P power supply to the DC 12V 500 mA power input. If the original supply is not available, use only a 12 volt DC,

500 mA adapter, with a barrel type plug that has the positive current on the tip. The outer diameter of the plug is 5.5 millimeter and the inner diameter is 2.1 millimeter.

OFF/ON SWITCH

Use the Off/On switch to turn the Nord Drum 3P Off and On.

⚠ *Always turn on the Nord Drum 3P first and the sound system last. Reverse this order when turning the unit off.*

ATTACHING THE STAND HOLDER

Use the included stand holder and screws to mount the Nord Drum 3P on a stand equipped with a clamp. The diameter is 23 millimeter (0.9 inches) which will fit most general purpose clamps.

The stand holder and four Phillips screws are attached as shown in the diagram below.

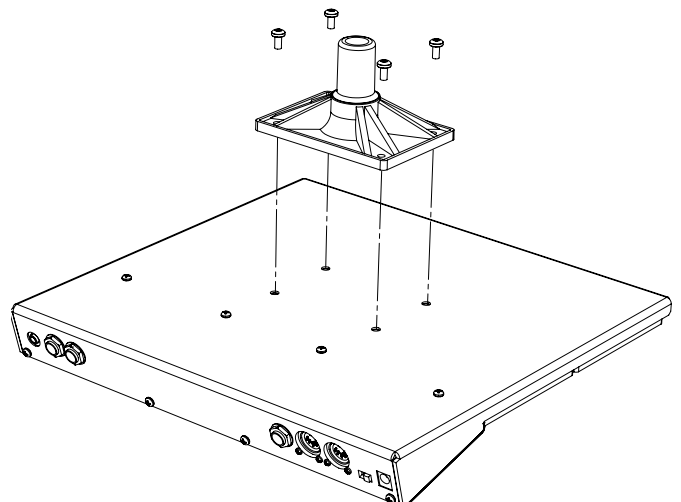

II APPENDIX: NORD DRUM 3 MANAGER



The Nord Drum 3 Manager is a free application which enables transferring Banks of Drum Kits and Drums to and from the Nord Drum 3P.

The application can be downloaded from the Nord Drum 3P section on www.nordkeyboards.com and is compatible with computers running Windows XP, Vista, Windows 7, 8 or 10, and Mac OSX 10.6 or later.

A MIDI interface is needed for the computer to communicate with the Nord Drum 3P. Select the MIDI Interface and Ports that the Nord Drum 3P is connected to, in the Setup Dialog.

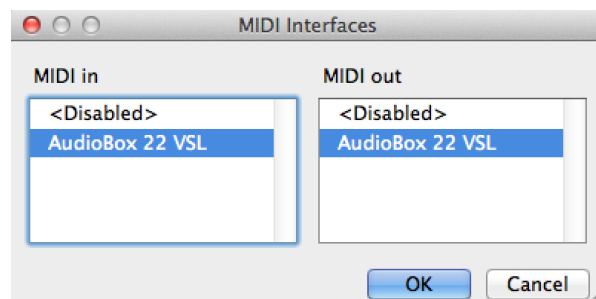

GET DRUM KIT BANKS

Drum Kit Banks can be saved on the computer hard drive by using the **KIT** “Get Bank” command. A retrieved bank will contain all the 50 Drum Kits and will be saved on the computer hard drive as a `.nd3_kitbank` file.

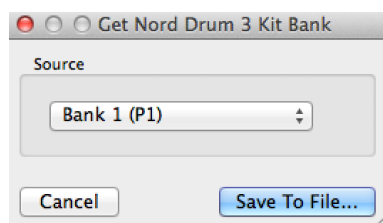

SEND DRUM KIT BANKS

Use the **KIT** “Send Bank” command, select a `.nd3_kitbank` file on the hard drive and then a destination, to transfer a bank to the Nord Drum 3P.

❗ Any Drum Kits in the destination bank will be overwritten.

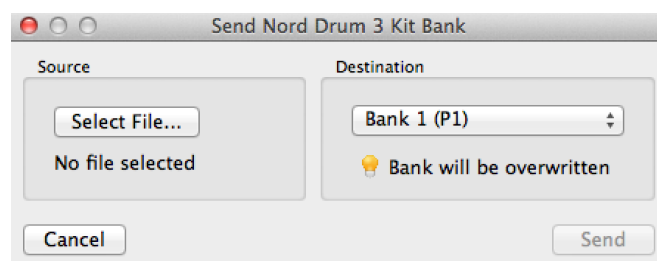

GET DRUM BANKS

Drum sounds can be saved on the computer hard drive by using the **DRUM** “Get Bank” command.

A retrieved bank will contain all the 50 Drum Kits and will be saved on the computer hard drive as a `.nd3_drumbank` file.

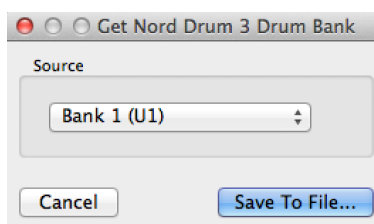

SEND DRUM BANKS

Use the **DRUM** “Send Bank” command, select a `.nd3_drumbank` file on the hard drive and then a destination, to transfer a bank to the Nord Drum 3P.

❗ Any Drum Sounds in the destination bank will be overwritten.

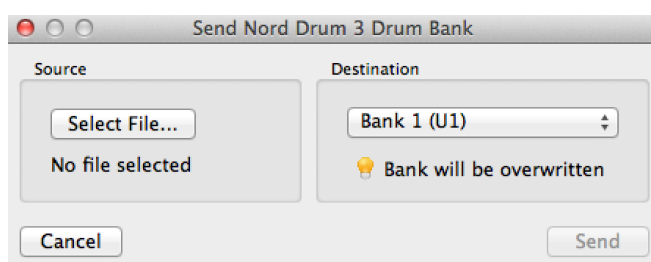

III INDEX

A

Audio Connections 16

B

Bend 9
BPM 11

C

CC 15
CC (Control Change) 12
Ch Level 10
Ch (MIDI Channel) 12
Ch Select 4
Click 10
Color 11
Connections 16
Control Change 12
Copy 11
Cymbals 9

D

Decay, Noise 8
Decay, Tone 9
Delay 11
Dial 4
Dist 10
Dly Amt 11
Drum 6
Drum Kit 6
Drum Kit Select 5, 6
Drum Kit/Value display 5
Drum Select 5, 6
Dy (Dynamics) 12
Dynamic Decay (Noise) 8
Dynamic Decay (Tone) 9
Dynamics 12
Dyn Filter, Noise 8
Dyn Filter, Tone 9

E

Edit All Ch 7
Eighth notes (BPM) 11
EQ 10
EQ Freq 10
EQ Gain 10
Exit 5, 11
Exponential (Decay mode) 8

F

Feedback 11
Filt Type 7
FM 9
Freq, Noise 8
Freq, Tone 9

G

Gate (Decay mode) 8
Get Drum Banks 17
Get Drum Kit Banks 17
GL (Global MIDI Ch) 12
Global MIDI Channel 12, 14
Global Settings 11

H

Hands (Pad Mode Type) 12
Harmonic resonance modelling 9

Headphones 16
High pass filter 7

I

Individual MIDI channels 14
Init Sound 13

K

Kick Connection 16
Kick (Pad Mode) 12
Kick (Pad Thres, Pad Sens) 12

L

Left Out 16
Level, Click 10
Linear (Decay mode) 8
Local Control 12
Lo (Local Control) 12
Lower Param 5, 7
Low pass filter 7

M

Master Level 5
Memory Protect 6, 11
MIDI 12
MIDI Channels 12
MIDI Controller 14
MIDI In 16
MIDI Note 12
MIDI Out 16
Mode, Noise Decay 8
Mode, Tone Decay 9
Mono Group 7

N

Noise 7
Noise Lvl 10
Nord Beat 15
Nord Drum 3 Manager 17
nt (MIDI note) 12

O

Off/On 16
OS, Update 13
Overdrive 10

P

Pad Follow 6
Pad Layout 12
Pad Mode 12
Pad Mode Type 12
Pad Sens 13
Pad Thres 12
Pan 10
Panel 4
Panic 7
Parameter buttons 5
Paste 11
PC (Program Change) 12
Peak/Focus 4
Pitch 9
Pitch control (MIDI) 14
PL (Pad Layout) 12
Power 16
Pr (Memory Protect) 11
ProG (Program Dump) 12
Program Change 12

Pulse wave 9
Punch (Tone Decay mode) 9

R

Rate 11
Receive (Drum Kit) 15
Recording 14
Resonance 7
Resonance modelling 9
Right Out 16
Ring modulation 10
Rvb Amt 10

S

Sample rate reduction 10
Sawtooth wave 9
Scl Pre 9
Send Drum Banks 17
Send (Drum Kit) 14
Send Drum Kit Banks 17
Sequencer 14, 15
Shift 5
Shift/Exit 5
Sine wave 9
Sixteenth notes (BPM) 11
Solo Part 7
Spectra 8
Square wave 9
Stand holder, Attaching 16
Sticks (Pad Mode Type) 12
Store Drum 6
Store Kit 6
Swap 11
System 11

T

Tap BPM 5, 11
T-bridge oscillator 9
Time, Bend 9
Tone 8
Tone Lvl 10
Triangle wave 9
Trig 5
Trig/Mono 4
Trig/Tap BPM 11
Ty (Pad Mode Type) 12
Type, Click 10
Type, Dist 10
Type, Reverb 11

V

Value 5

W

Wave 8

FCC Information (U.S.A.)

1. IMPORTANT NOTICE: DO NOT MODIFY THIS UNIT!

This product, when installed as indicated in the instructions contained in this manual, meets FCC requirements. Modifications not expressly approved by Clavia may void your authority, granted by the FCC, to use the product.

2. IMPORTANT: When connecting this product to accessories and/ or another product use only high quality shielded cables. Cable/s supplied with this product **MUST** be used. Follow all installation instructions. Failure to follow instructions could void your FCC authorization to use this product in the USA.

3. Note: This equipment has been tested and found to comply with the limits for a Class B digital device, pursuant to Part 15 of the FCC Rules. These limits are designed to provide reasonable protection against harmful interference in a residential installation. This equipment generates, uses, and can radiate radio frequency energy and, if not installed and used in accordance with the instructions, may cause harmful interference to radio communications. However, there is no guarantee that interference will not occur in a particular installation. If this equipment is found to be the source of interference to radio or television reception, which can be determined by turning the equipment off and on, the user is encouraged to try to correct the interference by one or more of the following measures:

- Reorient or relocate the receiving antenna.
- Increase the separation between the equipment and receiver.
- Connect the equipment into an outlet on a circuit different from that to which the receiver is connected.
- Consult the dealer or an experienced radio/TV technician for help.

This device complies with Part 15 of the FCC Rules. Operation is subject to the following two conditions:

- (1) this device may not cause harmful interference, and
- (2) this device must accept any interference received, including interference that may cause undesired operation.

Unauthorized changes or modification to this system can void the users authority to operate this equipment.

This equipment requires shielded interface cables in order to meet FCC class B Limit.

For Canada

NOTICE

This Class B - digital apparatus complies with Canadian ICES-003.

AVIS

Cet appareil numérique de la classe B - est conforme à la norme NMB-003 du Canada.

DECLARATION OF CONFORMITY Compliance Information Statement

Model Name: Nord Drum 3P

Type of Equipment: Digital drum unit

Responsible Party: Clavia DMI AB

Address: P.O. BOX 4214. SE-102 65 Stockholm Sweden

Telephone: +46-8-442 73 60

