

Owner's Manual

GUITAR AMPLIFIER

JAZZ CHORUS

JC-40

English

日本語

Deutsch

Français

Italiano

Español

Português

Nederlands

Main Features

The JC-40 is a 40W stereo-input/output guitar amp featuring a transparently clean tone that faithfully expresses the true character of your guitar.

- In addition to a 3-band tone-stack EQ, it also provides a bright switch, giving you a rich palette of tone settings.
- Its unique stereo-input design lets you connect a stereo effect unit to the front panel and enjoy a stereo effect using just a single amp.
- A beautifully dimensional space chorus effect and a unique vibrato are produced by spatial mixing (allowing the direct sound and effect sound to mix in the air).
- With two independent power amps and two custom-designed 10-inch speakers, the JC-40 delivers a stereo effect and sound that won't get buried in the ensemble.
- The enclosure is designed for strength and durability, made of hardened fiberboard and equipped with corner protectors.
- If a separately sold footswitch is connected, you can turn chorus/vibrato, reverb, and distortion on/off with your foot.

Dimensional space chorus

This uses two completely independent amps and speakers; one amp and speaker output the direct sound that is sent from the guitar, while the other amp and speaker output a sound that is subtly pitch-modulated. These two sounds are mixed in the air, creating a softly spacious three-dimensional effect that is warm, deep, and natural-sounding.

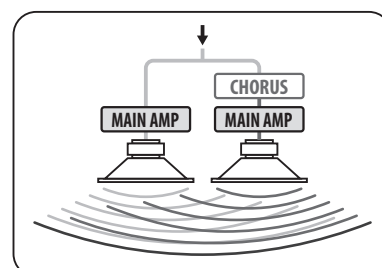



USING THE UNIT SAFELY







Before using this unit, carefully read "IMPORTANT SAFETY INSTRUCTIONS" (inside front cover), "USING THE UNIT SAFELY" (p. 2), and "IMPORTANT NOTES" (p. 3). After reading, keep the document(s) including those sections where it will be available for immediate reference.
Copyright © 2015 ROLAND CORPORATION

INSTRUCTIONS FOR THE PREVENTION OF FIRE, ELECTRIC SHOCK, OR INJURY TO PERSONS

About  WARNING and  CAUTION Notices

 WARNING	Used for instructions intended to alert the user to the risk of death or severe injury should the unit be used improperly.
 CAUTION	Used for instructions intended to alert the user to the risk of injury or material damage should the unit be used improperly. * Material damage refers to damage or other adverse effects caused with respect to the home and all its furnishings, as well to domestic animals or pets.

About the Symbols

	The  symbol alerts the user to important instructions or warnings. The specific meaning of the symbol is determined by the design contained within the triangle. In the case of the symbol at left, it is used for general cautions, warnings, or alerts to danger.
	The  symbol alerts the user to items that must never be carried out (are forbidden). The specific thing that must not be done is indicated by the design contained within the circle. In the case of the symbol at left, it means that the unit must never be disassembled.
	The  symbol alerts the user to things that must be carried out. The specific thing that must be done is indicated by the design contained within the circle. In the case of the symbol at left, it means that the power-cord plug must be unplugged from the outlet.

ALWAYS OBSERVE THE FOLLOWING

WARNING

Make sure that the power cord is grounded

Connect mains plug of this model to a mains socket outlet with a protective earthing connection.



To completely turn off power to the unit, pull out the plug from the outlet

Even with the power switch turned off, this unit is not completely separated from its main source of power. When the power needs to be completely turned off, turn off the power switch on the unit, then pull out the plug from the outlet. For this reason, the outlet into which you choose to connect the power cord's plug should be one that is within easy reach and readily accessible.



Secure a sufficient amount of space at the setup location

Since this unit normally emits a slight amount of heat, make sure to secure sufficient space around it, as shown below.

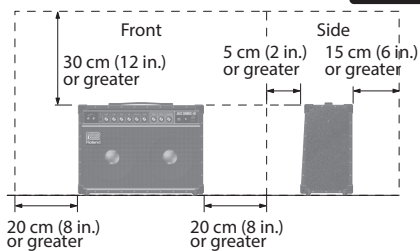

Do not disassemble or modify by yourself

Do not carry out anything unless you are instructed to do so in the owner's manual. Otherwise, you risk causing malfunction.



Do not repair or replace parts by yourself

Refer all servicing to your retailer, the nearest Roland Service Center, or an authorized Roland distributor, as listed on the "Information."



WARNING

Do not use or store in the following types of locations

- Subject to temperature extremes (e.g., direct sunlight in an enclosed vehicle, near a heating duct, on top of heat-generating equipment); or are
- Damp (e.g., baths, washrooms, on wet floors); or are
- Exposed to steam or smoke; or are
- Subject to salt exposure; or are
- Exposed to rain; or are
- Dusty or sandy; or are
- Subject to high levels of vibration and shakiness; or are
- Placed in a poorly ventilated location.



Do not place in an unstable location

Otherwise, you risk injury as the result of the unit toppling over or dropping down.



Connect the power cord to an outlet of the correct voltage

The unit should be connected to a power supply only of the type described as marked on the rear side of unit.



Use only the supplied power cord

Use only the attached power cord. Also, the supplied power cord must not be used with any other device.



Do not bend the power cord or place heavy objects on it

Otherwise, fire or electric shock may result.



Avoid extended use at high volume

Use of the unit at high volume for extended periods of time may cause hearing loss. If you ever experience any hearing loss or ringing in the ears, you should immediately stop using the unit and consult a specialized physician.



WARNING

Do not allow foreign objects or liquids to enter unit; never place containers with liquid on unit

Do not place containers containing liquid (e.g., flower vases) on this product. Never allow foreign objects (e.g., flammable objects, coins, wires) or liquids (e.g., water or juice) to enter this product. Doing so may cause short circuits, faulty operation, or other malfunctions.



Turn off the unit if an abnormality or malfunction occurs

Immediately turn the unit off, remove the power cord from the outlet, and request servicing by your retailer, the nearest Roland Service Center, or an authorized Roland distributor, as listed on the "Information" when:



- The power cord has been damaged; or
- If smoke or unusual odor occurs; or
- Objects have fallen into, or liquid has been spilled onto the unit; or
- The unit has been exposed to rain (or otherwise has become wet); or
- The unit does not appear to operate normally or exhibits a marked change in performance.

Be cautious to protect children from injury

Always make sure that an adult is on hand to provide supervision and guidance when using the unit in places where children are present, or when a child will be using the unit.



Do not drop or subject to strong impact

Otherwise, you risk causing damage or malfunction.



Do not share an outlet with an unreasonable number of other devices

Otherwise, you risk overheating or fire.



Do not use overseas

Before using the unit in overseas, consult with your retailer, the nearest Roland Service Center, or an authorized Roland distributor, as listed on the "Information."



⚠ CAUTION

When disconnecting the power cord, grasp it by the plug

To prevent conductor damage, always grasp the power cord by its plug when disconnecting it from this unit or from a power outlet.



Periodically clean the power plug

An accumulation of dust or foreign objects between the power plug and the power outlet can lead to fire or electric shock.



At regular intervals, be sure to pull out the power plug, and using a dry cloth, wipe away any dust or foreign objects that may have accumulated.

Disconnect the power plug whenever the unit will not be used for an extended period of time

Fire may result in the unlikely event that a breakdown occurs.



⚠ CAUTION

Route all power cords and cables in such a way as to prevent them from getting entangled

Injury could result if someone were to trip on a cable and cause the unit to fall or topple.



Avoid climbing on top of the unit, or placing heavy objects on it

Otherwise, you risk injury as the result of the unit toppling over or dropping down.



Never connect/disconnect a power plug if your hands are wet

Otherwise, you could receive an electric shock.



Disconnect all cords/cables before moving the unit

Before moving the unit, disconnect the power plug from the outlet, and pull out all cords from external devices.



⚠ CAUTION

Before cleaning the unit, disconnect the power plug from the outlet

If the power plug is not removed from the outlet, you risk receiving an electric shock.



Whenever there is a threat of lightning, disconnect the power plug from the outlet

If the power plug is not removed from the outlet, you risk receiving an electric shock.



IMPORTANT NOTES

Power Supply

- Do not connect this unit to same electrical outlet that is being used by an electrical appliance that is controlled by an inverter or a motor (such as a refrigerator, washing machine, microwave oven, or air conditioner). Depending on the way in which the electrical appliance is used, power supply noise may cause this unit to malfunction or may produce audible noise. If it is not practical to use a separate electrical outlet, connect a power supply noise filter between this unit and the electrical outlet.

Placement

- Using the unit near power amplifiers (or other equipment containing large power transformers) may induce hum. To alleviate the problem, change the orientation of this unit; or move it farther away from the source of interference.
- This unit may interfere with radio and television reception. Do not use this unit in the vicinity of such receivers.
- Noise may be produced if wireless communications devices, such as cell phones, are operated in the vicinity of this unit. Such noise could occur when receiving or initiating a call, or while conversing. Should you experience such problems, you should relocate such wireless devices so they are at a greater distance from this unit, or switch them off.
- When moved from one location to another where the temperature and/or humidity is very different, water droplets (condensation) may form inside the unit. Damage or malfunction may result if you attempt to use the unit in this condition. Therefore, before using the unit, you must allow it to stand for several hours, until the condensation has completely evaporated.
- Depending on the material and temperature of the surface on which you place the unit, its rubber feet may discolor or mar the surface.
- Do not place containers or anything else containing liquid on top of this unit. Also, whenever any liquid has been spilled on the surface of this unit, be sure to promptly wipe it away using a soft, dry cloth.

Maintenance

- Never use benzine, thinners, alcohol or solvents of any kind, to avoid the possibility of discoloration and/or deformation.

Additional Precautions

- Use a reasonable amount of care when using the unit's buttons, sliders, or other controls; and when using its jacks and connectors. Rough handling can lead to malfunctions.
- When disconnecting all cables, grasp the connector itself—never pull on the cable. This way you will avoid causing shorts, or damage to the cable's internal elements.
- A small amount of heat will radiate from the unit during normal operation.
- To avoid disturbing others nearby, try to keep the unit's volume at reasonable levels.
- Do not use connection cables that contain a built-in resistor.

Intellectual Property Right

- Roland and BOSS are either registered trademarks or trademarks of Roland Corporation in the United States and/or other countries.
- Company names and product names appearing in this document are registered trademarks or trademarks of their respective owners.

English

日本語

Deutsch

Français

Italiano

Español

Português

Nederlands

Panel Descriptions

Front Panel

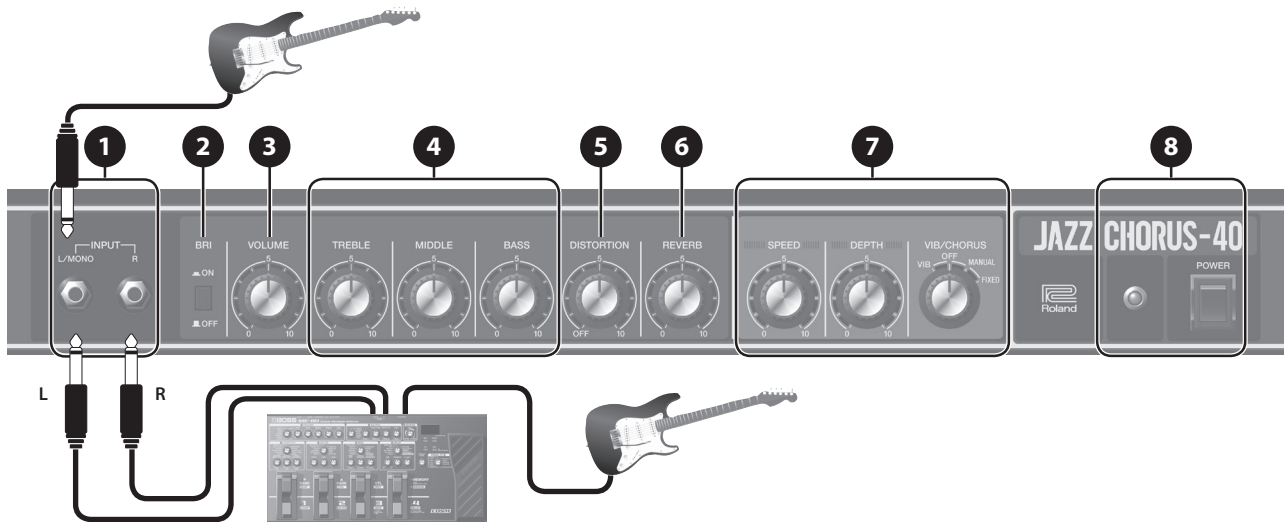

1 INPUT jacks

Connect your electric guitar or effect unit here. If you're connecting a guitar directly, or a monaural effect unit, connect it to the L/MONO jack. If you connect a stereo-output effect unit to these jacks, you'll obtain a stereo effect with the left and right speakers of the JC-40.

* If you connect your guitar to the R jack, the sound is heard only from the right speaker.

2 [BRI] (Bright) switch

Brightens the mid- and high-frequency range, making the sound more crisp.

3 [VOLUME] knob

Adjusts the overall volume.

4 [TREBLE] / [MIDDLE] / [BASS] knobs

Adjust the volume of the high-, mid-, and low-frequency ranges respectively.

5 [DISTORTION] knob

Adjusts the amount of distortion. If this is set to "OFF," distortion is not applied.

6 [REVERB] knob

Adjusts the reverb depth.

7 VIB/CHORUS

The JC-40 features dimensional space chorus and vibrato effects.

* The [SPEED] knob and [DEPTH] knob have no effect when the [VIB/CHORUS] switch is set to "FIXED."

[SPEED] knob

Adjusts the modulation speed of chorus and vibrato.

[DEPTH] knob

Adjusts the modulation depth of chorus and vibrato.

[VIB/CHORUS] switch

Switches between chorus and vibrato.

Value	Explanation
VIB (vibrato)	Turns vibrato on.
OFF	Turns vibrato/chorus off.
MANUAL (chorus)	Turns chorus on. Use the [SPEED] knob and [DEPTH] knob to adjust the speed and depth of the modulation.
FIXED (chorus)	Turns chorus on. The [SPEED] knob and [DEPTH] knob have no effect; their settings are fixed.

8 [POWER] switch

Turns the power of the JC-40 on/off. When the power is on, the indicator is lit.

Turning the Power On/Off

Once everything is properly connected, be sure to follow the procedure below to turn on their power. If you turn on equipment in the wrong order, you risk causing malfunction or equipment failure.

1. Make sure that the JC-40's [VOLUME] knob and the volume of the devices connected to the JC-40 are set to 0.

* Before connecting your instrument to the JC-40's INPUT jacks, set the [VOLUME] knob to the minimum setting (far left).

2. Turn on the JC-40.

* Before turning the unit on/off, always be sure to turn the volume down. Even with the volume turned down, you might hear some sound when switching the unit on/off. However, this is normal and does not indicate a malfunction.

* This unit is equipped with a protection circuit. A brief interval (a few seconds) after turning the unit on is required before it will operate normally.



3. Turn on the power of the connected devices.

4. Adjust the volume levels for the devices.

Before switching off the power, lower the volume on each of the devices in your system and then TURN OFF the devices in the reverse order to which they were switched on.

* If you need to turn off the power completely, first turn off the unit, then unplug the power cord from the power outlet. Refer to "To completely turn off power to the unit, pull out the plug from the outlet" (p. 2).

Rear Panel

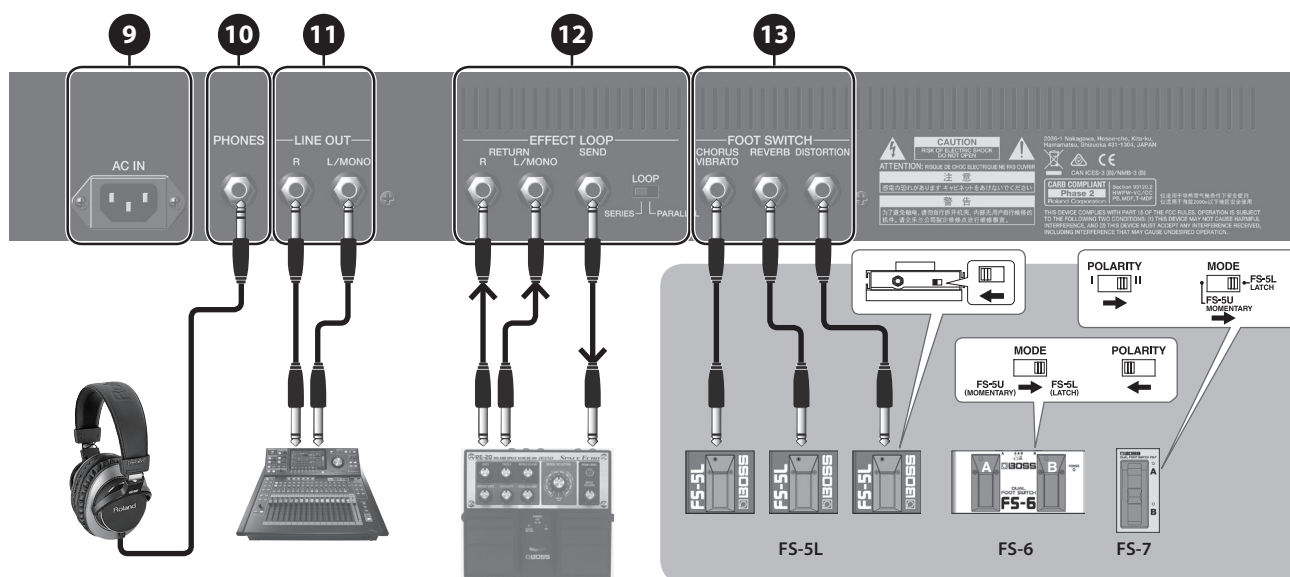

9 AC IN jack

Connect the included power cord.

- * Use only the power cord that was included with the unit.

10 PHONES jack

Connect headphones here.

- * If a plug is inserted in this jack, no sound will be output from the JC-40's own speaker.

11 LINE OUT jacks

Connect these to your PA system or recorder.

You can use this in conjunction with an external PA system, or to record your performance via direct line while monitoring the sound from the JC-40's speaker.

If you're using a monaural connection, connect your equipment to the L/MONO jack.

- * If chorus is on and you connect the line out in stereo, the dimensional space chorus effect (L: direct sound, R: effect sound) is obtained.

12 EFFECT LOOP SEND/RETURN jacks

Connect an external effect device.

Connect the SEND jack to the input of your external effect device, and connect the output of your external effect device to the RETURN jack.

If you connect a stereo effect unit, the stereo effect is obtained using the JC-40's left and right speakers. If you're connecting a monaural effect unit, connect it to the L/MONO jack.

- * If you connect only the R jack, sound is not output from the speakers, the LINE OUT jacks, and the PHONES jack.
- * The sound that is input from the RETURN jacks is not affected by front panel controls 2-5. If you want controls 2-5 to affect this sound, connect your equipment to the front panel INPUT (L/MONO, R) jacks.
- * Make connections after first checking the wiring diagrams of other equipment you intend to connect. To prevent malfunction and equipment failure, always turn down the volume, and turn off all the units before making any connections.

[LOOP] switch

When "PARALLEL" is set, the external effects sound and the direct sound are mixed.

When "SERIES" is set, only the external effects sound is played.

- * When "SERIES" is set, there will be no sound if the volume of your external effect device is turned down or if it is powered-off.
- ➔ For details on the EFFECT LOOP SEND/RETURN jacks and the [LOOP] switch, refer to "Block Diagram" at the end of this manual.

13 FOOT SWITCH jacks

If a separately sold footswitch (BOSS FS-5L, FS-6, FS-7) is connected, you can turn chorus/vibrato, reverb, and distortion on/off with your foot.

- * The JC-40 is compatible with latch-type footswitches (FS-5L, FS-6, FS-7). If you're using an FS-6 or FS-7, set the mode of A and B to FS-5L (LATCH).
- * If you're using an FS-6 or FS-7, connect a 1/4" plug (monaural) to jack A or B.
- * If you're using the A&B jack of the FS-6, use a stereo 1/4" plug ↔ two 1/4" monaural plugs (sold separately: PCS-31L, etc.).

Main Specifications

Roland JC-40: Guitar Amplifier

Rated Power Output	40 W
Nominal Input Level	INPUT L/MONO, R jacks: -10 dBu (1 M Ω) EFFECT RETURN L/MONO, R jacks: -10 dBu (22 k Ω) EFFECT RETURN L/MONO only: -10 dBu (11 k Ω)
Speakers	25 cm (10 inches) x 2
Controls	[POWER] switch [BRI] (Bright) Switch [VOLUME] knob [TREBLE] knob [MIDDLE] knob [BASS] knob [DISTORTION] knob [REVERB] knob [SPEED] knob [DEPTH] knob [VIB/CHORUS] switch [EFFECT LOOP] switch
Indicator	POWER
Connectors	INPUT L/MONO, R jacks: 1/4-inch phone type LINE OUT L/MONO, R jacks: 1/4-inch phone type PHONES jack: Stereo 1/4-inch TRS phone type FOOT SWITCH (CHORUS VIBRATO, REVERB, DISTORTION) jacks: 1/4-inch phone type EFFECT LOOP SEND jack: 1/4-inch phone type EFFECT LOOP RETURN L/MONO, R jacks: 1/4-inch phone type AC IN jack
Power Consumption	43 W
Dimensions	592 (W) x 251 (D) x 436 (H) mm 23-5/16 (W) x 9-15/16 (D) x 17-3/16 (H) inches
Weight	15.8 kg 34 lbs 14 oz
Accessories	Owner's manual Power cord
Options (sold separately)	Footswitch (BOSS FS-5L, FS-6, FS-7)

* 0 dBu = 0.775 Vrms

* In the interest of product improvement, the specifications and/or appearance of this unit are subject to change without prior notice.

Block Diagram

JC-40 Block Diagram

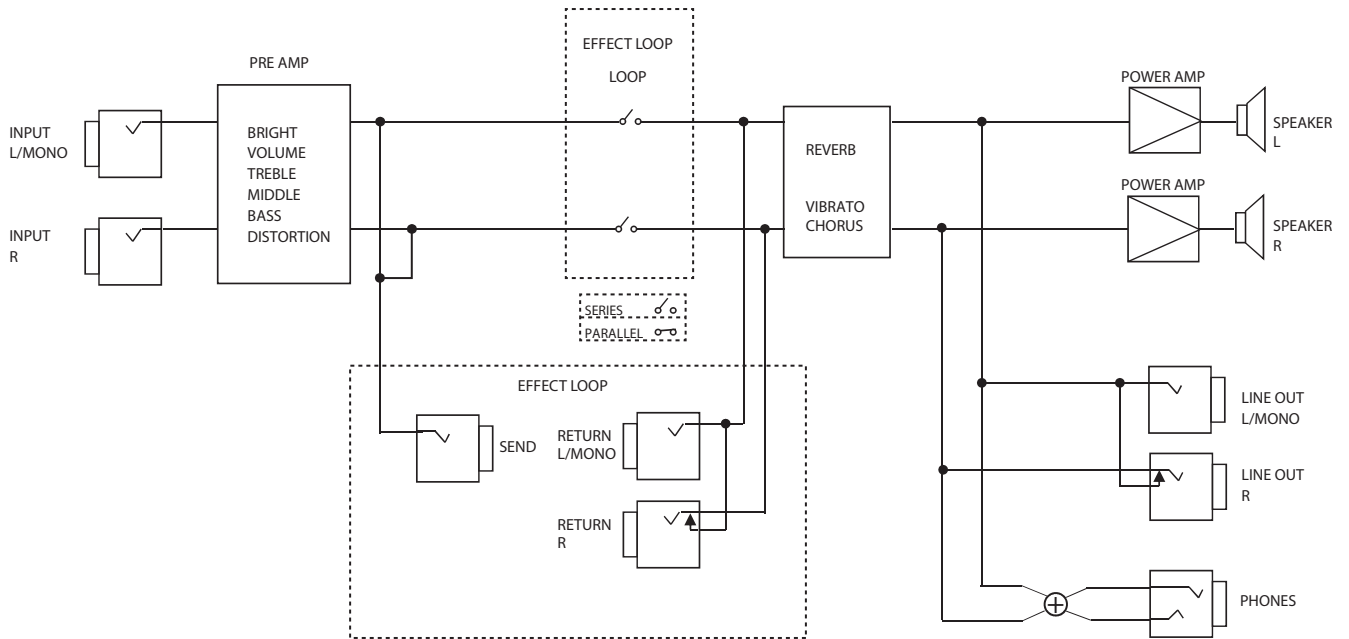

EFFECT LOOP (series)

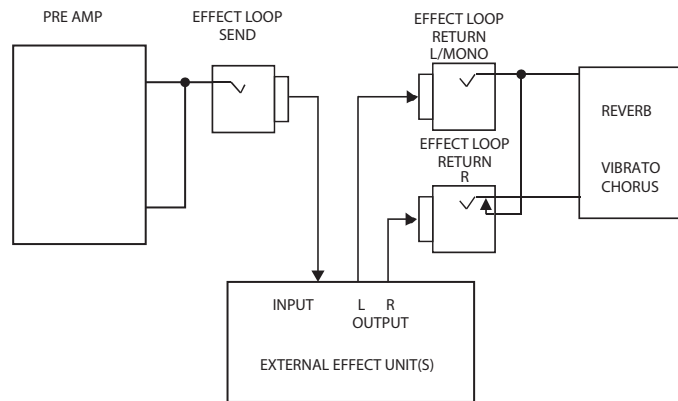

EFFECT LOOP (parallel)

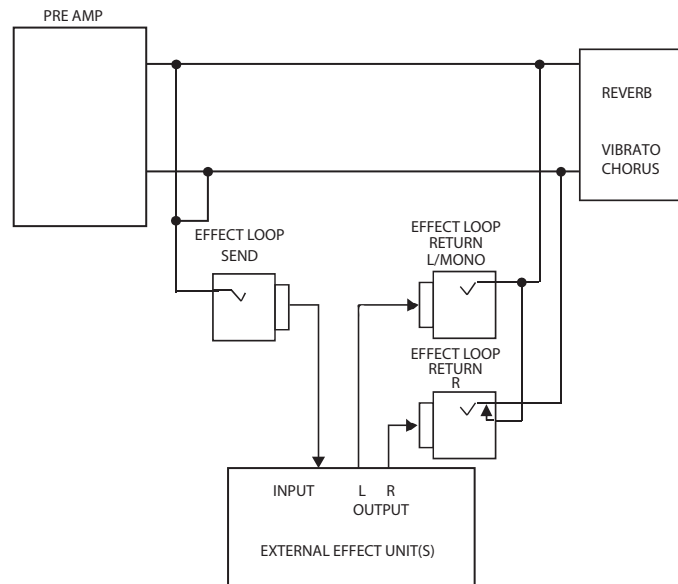

Information

When you need repair service, call your nearest Roland Service Center or authorized Roland distributor in your country as shown below.

AFRICA

REUNION

MARCEL FO-YAM Sarl
25 Rue Jules Hermann,
Chaudron - BP79 97 491
Ste Clotilde Cedex,
REUNION ISLAND
TEL: (0262) 218-429

SOUTH AFRICA

Paul Bothner(Pty)Ltd.
Royal Cape Park, Unit 24
Londonderry Road, Ottery 7800
Cape Town, SOUTH AFRICA
TEL: (021) 799 4900

ASIA

CHINA

Roland Shanghai Electronics Co.,Ltd.
5F, No.1500 Pingliang Road,
Yangpu Shanghai 200090, CHINA
TEL: (021) 5580-0800
Toll Free: 4007-888-010

Roland Shanghai Electronics Co.,Ltd. (BEIJING OFFICE)
3F, Soluxe Fortune Building
63 West Dawang Road,
Chaoyang Beijing, CHINA
TEL: (010) 5960-2565/0777
Toll Free: 4007-888-010

HONG KONG

Tom Lee Music
11/F Silvercord Tower 1
30 Canton Rd
Tsimshatsui, Kowloon,
HONG KONG
TEL: 852-2737-7688

Parsons Music Ltd.

8th Floor, Railway Plaza, 39
Chatham Road South, T.S.T,
Kowloon, HONG KONG
TEL: 852-2333-1863

INDIA

Rivera Digitec (India) Pvt. Ltd.
411, Nirman Kendra Mahalaxmi
Flats Compound Off. Dr. Edwin
Moses Road, Mumbai-400011,
INDIA
TEL: (022) 2493 9051

INDONESIA

PT. Citra Intirama
Ruko Garden Shopping Arcade
Unit 8 CR, Podomoro City
J.Letjend. S.Parmar Kav.28
Jakarta Barat 11470, INDONESIA
TEL: (021) 5698-5519/5520

KAZAKHSTAN

Alatau Dybybystary
141 Abylar-Khan ave, 1st floor,
050000 Almaty, KAZAKHSTAN
TEL: (727) 2725477
FAX: (727) 2720730

KOREA

Cosmos Corporation
27, Banpo-daero, Seocho-gu,
Seoul, KOREA
TEL: (02) 3486-8855

MALAYSIA

Roland Asia Pacific Sdn. Bhd.
45-1, Block C2, Jalan PJU 1/39,
Dataran Prima, 47301 Petaling
Jaya, Selangor, MALAYSIA
TEL: (03) 7805-3263

MYANMAR

THAW AND ZIN FAMILY CO., LTD.
4061-4062, Taw Win Center,
Level-3, Yangon, MYANMAR
TEL: 09 31010744 / 09 5061300

PHILIPPINES

G.A. Yupangco & Co. Inc.
339 Gil J. Puyat Avenue
Makati, Metro Manila 1200,
PHILIPPINES
TEL: (02) 899 9801

SINGAPORE

Swee Lee Service Centre
12 Jalan Kilang Barat #01-00
Singapore 159354
TEL: (+65) 6376 6141

TAIWAN

ROLAND TAIWAN ENTERPRISE CO., LTD.
9F-5, No. 112 Chung Shan
North Road Sec. 2 Taipei 104,
TAIWAN R.O.C.
TEL: (02) 2561 3339

THAILAND

Theera Music Co., Ltd.
100-108 Soi Verng
Nakornkasem, New Road,
Sumpantawong, Bangkok
10100, THAILAND
TEL: (02) 224-8821

VIET NAM

VIET THUONG CORPORATION
386 CACH MANG THANG TAM ST.
DIST.3, HO CHI MINH CITY,
VIET NAM
TEL: (08) 9316540

CARIBBEAN

BARBADOS

A&B Music Supplies LTD
12 Webster Industrial Park
Wildely, St.Michael, BARBADOS
TEL: (246) 430-1100

CURACAO

Zeelandia Music Center Inc.
Orionweg 30
Curacao, Netherland Antilles
TEL: (305) 5926866

DOMINICAN REPUBLIC

Instrumentos Fernando Giraldez
Calle Roberto Pastoriza #325
Sanchez Naco Santo Domingo,
DOMINICAN REPUBLIC
TEL: (809) 683 0305

MARTINIQUE

Musique & Son
Z.Les Mangle
97232 Le Lamentin,
MARTINIQUE F.W.I.
TEL: 596 596 426860

TRINIDAD

AMR Ltd
Ground Floor Maritime Plaza
Barataria TRINIDAD W.I.
TEL: (868) 638 6385

CENTRAL/SOUTH AMERICA

ARGENTINA

Instrumentos Musicales S.A.
Av.Santa Fe 2055
(1123) Buenos Aires, ARGENTINA
TEL: (011) 4508-2700

BRAZIL

Roland Brasil Ltda.
Rua San Jose, 211
Parque Industrial San Jose
Cotia - Sao Paulo - SP, BRAZIL
TEL: (011) 4615 5666

CHILE

Audiomusica SpA
Av. Chile España 393
Ñuñoa
Santiago, CHILE
TEL: (+56) 2 2384 20 00

COLOMBIA

CENTRO MUSICAL S.A.S.
Parque Industrial del Norte
Bodega 130
GIRARDOTA - ANTIOQUIA,
COLOMBIA
TEL: (454) 57 77 EXT 115

COSTA RICA

JUAN Bansbach Instrumentos Musicales
Ave.1, Calle 11, Apartado 10237,
San Jose, COSTA RICA
TEL: 258-0211

ECUADOR

Mas Musica
Rumichaca 822 y Zaruma
Guayaquil - ECUADOR
TEL: (593-4) 2302364

EL SALVADOR

OMNI MUSIC
75 Avenida Norte y Final Alameda
Juan Pablo II, Edificio No.4010
San Salvador, EL SALVADOR
TEL: 262-0788

GUATEMALA

Casa Instrumental
Calzada Roosevelt 34-01,zona
11 Ciudad de Guatemala,
GUATEMALA
TEL: (502) 599-2888

HONDURAS

Almacen Pajaro Azul S.A. de C.V.
B.O.Paz Barahona
3 Ave.11 Calle S.O
San Pedro Sula, HONDURAS
TEL: (504) 553-2029

NICARAGUA

Bansbach Instrumentos Musicales Nicaragua
Altamira D'Este Calle Principal
de la Farmacia 5ta.Avenida
1 Cuadra al Lago,#503
Managua, NICARAGUA
TEL: (505) 277-2557

PANAMA

SUPRO MUNDIAL, S.A.
Boulevard Andrews, Albrook,
Panama City, REP. DE PANAMA
TEL: 315-0101

PARAGUAY

WORLD MUSIC
Jebai Center 2018, Centro
CIUDAD DE ESTE, PARAGUAY
TEL: (595) 615 059

PERU

Audiomusica Peru SAC
Av.Angamos Oeste 737
Piso 3
Miraflores
Lima, PERU
TEL: (+57) 1 2557005

URUGUAY

Todo Musica S.A.
Francisco Acuna de Figueroa
1771
C.P.: 11.800
Montevideo, URUGUAY
TEL: (02) 924-2335

VENEZUELA

Instrumentos Musicales Allegro,C.A.
Av.Las industrias edf.Guitar
import #7 zona Industrial de
Turumo Caracas, VENEZUELA
TEL: (212) 244-1122

EUROPE

BELGIUM/FRANCE/

HOLLAND/ LUXEMBOURG
Roland Central Europe N.V.
Houtstraat 3, B-2260, Oevel
(Westerlo) BELGIUM
TEL: (014) 575811

BOSNIA AND HERZEGOVINA

Mix-AP Music
78000 Banja Luka, Veselina
Madlese 3,
BOSNIA AND HERZEGOVINA
TEL: 65 403 168

CROATIA

ART-CENTAR
Degenova 3.
HR - 10000 Zagreb, CROATIA
TEL: (1) 466 8493

EUROMUSIC AGENCY

K. Racina 1/15
HR - 40000 CAKOVEC, CROATIA
Tel: 40-370-841

CZECH REPUBLIC

CZECH REPUBLIC DISTRIBUTOR s.r.o
Pod Bani 8
180 00 Praha 8, CZECH REP.
TEL: 266 312 557

DENMARK/ESTONIA/

LATVIA/LITHUANIA
Roland Scandinavia A/S
Skagerrakvej 7, DK-2150
Nordhavn, DENMARK
TEL: 39166200

FINLAND

Roland Scandinavia As, Filial Finland
Vanha Nurmijarventie 62
01670 Vantaa, FINLAND
TEL: (0) 9 68 24 020

GERMANY/AUSTRIA

ROLAND Germany GmbH.
Adam-OpeI-Strasse 4, 64569
Nauheim, GERMANY
TEL: 6152 95546-00

GREECE/CYPRUS

STOLLAS S.A.
Music Sound Light
155, New National Road
Patras 26442, GREECE
TEL: 2610 435400

HUNGARY

Roland East Europe Ltd.
2045. Törökbálint, FSD Park 3. ép.,
HUNGARY
TEL: (23) 511 011

IRELAND

Roland Ireland
E2 Calmount Park, Calmount
Avenue, Dublin 12,
Republic of IRELAND
TEL: (01) 4294444

ITALY

Roland Italy S. p. A.
Viale delle Industrie 8,
20020 Arese, Milano, ITALY
TEL: (02) 937781

MACEDONIA

MK MJUZIK
Bratstvo Edinstvo 9
2208 Lozovo, MACEDONIA
TEL: 70 264 458

MONTENEGRO

MAX-AP
P. Fah 92
Przno, Kamenovo bb
86000 Budva, MONTENEGRO
TEL: 33 452-820

NORWAY

Roland Scandinavia Avd. Kontor Norge
Lilleakerveien 2 Postboks 95
Lilleaker N-0216 Oslo,
NORWAY
TEL: 2273 0074

POLAND

ROLAND POLSKA SP. Z O.O.
ul. Katy Grodziskie 16B
03-289 Warszawa, POLAND
TEL: (022) 678 9512

PORTUGAL

Roland Iberia S.L. Branch Office Porto
Rua 5 de Outubro nº 5587
4465-082 Sao Mamede de
Infesta, Porto, PORTUGAL
TEL: (+351) 22 01 39 526

ROMANIA

Pro Music Concept SRL
440221 Satu Mare
B-dul Independentei nr. 14/a.,
ROMANIA
TEL: (0361) 807-333

RUSSIA

Roland Music LLC
Dorozhnaya ul.3,korp.6
117 545 Moscow, RUSSIA
TEL: (495) 981-4967

SERBIA

MUSIC AP
Sutjeska br. 5 XS - 24413 PALIC,
SERBIA
TEL: (0) 24 539 395

SLOVAKIA

DAN Distribution, s.r.o.
Povazská 18.
SK - 940 01 Nové Zámky,
SLOVAKIA
TEL: (035) 6424 330

SPAIN

Roland Iberia S.L.
Llacuna, 161, 2^a-2^a
08018 Barcelona, SPAIN
TEL: (00 34) 93 493 91 36

SWEDEN

Roland Scandinavia A/S SWEDISH SALES OFFICE
Mårbackagatan 31, 4 tr.
SE-123 43 Farsta, SWEDEN
TEL: (0) 8 683 04 30

SWITZERLAND

Roland (Switzerland) AG
Landstrasse 5, Postfach,
CH-4452 Itingen, SWITZERLAND
TEL: (061) 975-9987

TURKEY

ZUHAL DIS TICARET A.S.
Galip Dede Cad. No.33
Beyoğlu, Istanbul, TURKEY
TEL: (0212) 249 85 10

UKRAINE

EURHYTHMICS Ltd.
P.O.Box: 37-a
Nedecy Str. 30
UA - 89600 Mukachevo,
UKRAINE
TEL: (03131) 314-40

UNITED KINGDOM

Roland (U.K.) Ltd.
Atlantic Close, SWANSEA SA7
9FJ, UNITED KINGDOM
TEL: (01792) 702701

MIDDLE EAST

BAHRAIN

Moon Stores
No.1231&1249 Rumaytha
Building Road 3931,
Manama 339, BAHRAIN
TEL: 17 813 942

EGYPT

Al Fanny Trading Office
9, EBN Hagar Al Askalany Street,
ARD E1 Golf, Heliopolis,
Cairo 11341, EGYPT
TEL: (022)-417-1828

IRAN

MOCO INC.
Jadeh Makhsoos Karaj (K-9),
Nakhe Zarin Ave.
Jalal Street, Reza Alley No.4
Tehran 1389716791, IRAN
TEL: (021)-44545370-5

ISRAEL

Haliit P. Greenspoon & Sons Ltd.
8 Retziv Ha'alia Hashnia St.
Tel-Aviv-Yafo ISRAEL
TEL: (03) 6823666

JORDAN

MUSIC HOUSE CO. LTD. FREDDY FOR MUSIC
P. O. Box 922846
Amman 11192, JORDAN
TEL: (06) 5692696

KUWAIT

EASA HUSAIN AL-YOUSIFI & SONS CO.
Al-Yousifi Service Center
P.O.Box 126 (Safat) 13002,
KUWAIT
TEL: 00 965 802929

LEBANON

Chahine S.A.L.
George Zeidan St., Chahine Bldg,
Achrafieh, P.O.Box: 16-5857
Beirut, LEBANON
TEL: (01) 20-1441

OMAN

TALENTZ ENTERPRISES LLC
Malatan House No.1
Al Noor Street, Ruwi
SULTANATE OF OMAN
TEL: 2478 3443

QATAR

AL-EMADITRADING & CONTRACTING CO.
P.O. Box 62, Doha, QATAR
TEL: 4423-554

SAUDI ARABIA

Adawliah Universal Electronics APL
Behind Pizza Inn
Prince Turkey Street
Adawliah Building,
PO BOX 2154,
Al Khobar 31952,
SAUDI ARABIA
TEL: (03) 8643601

SYRIA

Technical Light & Sound Center
PO Box 13520 Bldg No.49
Khaled Abn Alwalid St.
Damascus, SYRIA
TEL: (011) 223-5384

U.A.E.

Adawliah Universal Electronics APL
Omar bin alkhattab street, fish
round about, nayef area, deira,
Dubai, U.A.E.
TEL: (04) 2340442

NORTH AMERICA

CANADA

Roland Canada Ltd. (Head Office)
5480 Parkwood Way Richmond
B. C., V6V 2M4, CANADA
TEL: (604) 270 6626

Roland Canada Ltd. (Toronto Office)

170 Admiral Boulevard
Mississauga On L5T 2N6,
CANADA
TEL: (905) 362 9707

MEXICO

Casa Veerkamp, s.a. de c.v.
Av. Toluca No. 323, Col. Olivar
de los Padres 01780 Mexico D.F.,
MEXICO
TEL: (55) 5668-6699

Faly Music

Sucursal Capu Blvd. Norte N.3213
Col. Nueva Aurora Cp.72070
Puebla, Puebla, MEXICO
TEL: (01) (222) 2315567 o 97
FAX: 01 (222) 2266241

Gama Music S.A. de C.V.

Madero Pte. 810 Colonia Centro
C.P. 64000 Monterrey, Nuevo
León, MEXICO
TEL: (01) (81) 8374-1640 o 8372-4097
www.gamamusic.com

Holocausto Music

Bolivar No.62 y 76, Col.Centro
Del.Cuahutemoc
Mexico D.F. CP 06080, MEXICO
TEL: 52-55 5709 9046

Top Music S de RL de CV

Mesones 13 Local B
Col Centro Del Cuahutemoc
Mexico D.F. CP 06080, MEXICO
TEL: 52-55-57099090

U. S. A.

Roland Corporation U.S.
5100 S. Eastern Avenue
Los Angeles, CA 90040-2938,
U. S. A.
TEL: (323) 890 3700

OCEANIA

AUSTRALIA/NEW ZEALAND

Roland Corporation Australia Pty.,Ltd.
38 Campbell Avenue, Dee Why
West. NSW 2099, AUSTRALIA

For Australia
TEL: (02) 9982 8266

For New Zealand
TEL: (09) 3098 715

For EU Countries



- UK** This symbol indicates that in EU countries, this product must be collected separately from household waste, as defined in each region. Products bearing this symbol must not be discarded together with household waste.
- DE** Dieses Symbol bedeutet, dass dieses Produkt in EU-Ländern getrennt vom Hausmüll gesammelt werden muss gemäß den regionalen Bestimmungen. Mit diesem Symbol gekennzeichnete Produkte dürfen nicht zusammen mit dem Hausmüll entsorgt werden.
- FR** Ce symbole indique que dans les pays de l'Union européenne, ce produit doit être collecté séparément des ordures ménagères selon les directives en vigueur dans chacun de ces pays. Les produits portant ce symbole ne doivent pas être mis au rebut avec les ordures ménagères.
- IT** Questo simbolo indica che nei paesi della Comunità europea questo prodotto deve essere smaltito separatamente dai normali rifiuti domestici, secondo la legislazione in vigore in ciascun paese. I prodotti che riportano questo simbolo non devono essere smaltiti insieme ai rifiuti domestici. Ai sensi dell'art. 13 del D.Lgs. 25 luglio 2005 n. 151.
- ES** Este símbolo indica que en los países de la Unión Europea este producto debe recogerse aparte de los residuos domésticos, tal como esté regulado en cada zona. Los productos con este símbolo no se deben depositar con los residuos domésticos.
- PT** Este símbolo indica que nos países da UE, a recolha deste produto deverá ser feita separadamente do lixo doméstico, de acordo com os regulamentos de cada região. Os produtos que apresentem este símbolo não deverão ser eliminados juntamente com o lixo doméstico.
- NL** Dit symbool geeft aan dat in landen van de EU dit product gescheiden van huishoudelijk afval moet worden aangeboden, zoals bepaald per gemeente of regio. Producten die van dit symbool zijn voorzien, mogen niet samen met huishoudelijk afval worden verwijderd.
- DK** Dette symbol angiver, at i EU-lande skal dette produkt opsamles adskilt fra husholdningsaffald, som defineret i hver enkelt region. Produkter med dette symbol må ikke smides ud sammen med husholdningsaffald.
- NO** Dette symbolet indikerer at produktet må behandles som spesialavfall i EU-land, iht. til retningslinjer for den enkelte regionen, og ikke kastes sammen med vanlig husholdningsavfall. Produkter som er merket med dette symbolet, må ikke kastes sammen med vanlig husholdningsavfall.

- SE** Symbolen anger att i EU-länder måste den här produkten kasseras separat från hushållsavfall, i enlighet med varje regions bestämmelser. Produkter med den här symbolen får inte kasseras tillsammans med hushållsavfall.
- FI** Tämä merkitä ilmaisee, että tuote on EU-maissa kerättävä erillään kotitalousjätteistä kunkin alueen voimassa olevien määräysten mukaisesti. Tällä merkinnällä varustettuja tuotteita ei saa hävittää kotitalousjätteiden mukana.
- HU** Ez a szimbólum azt jelenti, hogy az Európai Unióban ezt a terméket a háztartási hulladéktól elkülönítve, az adott régióban érvényes szabályozás szerint kell gyűjteni. Az ezzel a szimbóllummal ellátott termékeket nem szabad a háztartási hulladék közé dobni.
- PL** Symbol oznacza, że zgodnie z regulacjami w odpowiednim regionie, w krajach UE produktu nie należy wyrzucać z odpadami domowymi. Produktów opatrzonych tym symbolem nie można utylizować razem z odpadami domowymi.
- CZ** Tento symbol udává, že v zemích EU musí být tento výrobek sbírán odděleně od domácího odpadu, jak je určeno pro každý region. Výrobky nesoucí tento symbol se nesmí vyhazovat spolu s domácím odpadem.
- SK** Tento symbol vyjadruje, že v krajinách EÚ sa musí zber tohto produktu vykonávať oddelene od domového odpadu, podľa nariadení platných v konkrétnej krajine. Produkty s týmto symbolom sa nesmú vyhazovať spolu s domovým odpadom.
- EE** See sümbol näitab, et EL-i maades tuleb see toode olemprügist eraldi koguda, nii nagu on igas piirkonnas määratletud. Selle sümboliga märgitud tooteid ei tohi ära visata koos olmeprügiga.
- LT** Šis simbolis rodo, kad ES šalyse šis produktas turi būti surenkamas atskirai nuo buitinių atliekų, kaip nustatyta kiekviename regione. Šiuo simboliu paženklinoti produktai neturi būti išmetami kartu su buitiniems atliekoms.
- LV** Šis simbols norāda, ka ES valstīs šo produktu jāievāc atsevišķi no mājsaimniecības atkritumiem, kā noteikts katrā reģionā. Produkta ar šo simbolu nedrīkst izmest kopā ar mājsaimniecības atkritumiem.
- SI** Ta simbol označuje, da je treba proizvod v državah EU zbirati ločeno od gospodinjjskih odpadkov, tako kot je določeno v vsaki regiji. Proizvoda se tem znakom ni dovoljeno odlagati skupaj z gospodinjjskimi odpadki.
- GR** Το σύμβολο αυτό υποδηλώνει ότι στις χώρες της Ε.Ε. το συγκεκριμένο προϊόν πρέπει να συλλέγεται χωριστά από τα υπόλοιπα οικιακά απορρίμματα, σύμφωνα με όσα προβλέπονται σε κάθε περιοχή. Τα προϊόντα που φέρουν το συγκεκριμένο σύμβολο δεν πρέπει να απορρίπτονται μαζί με τα οικιακά απορρίμματα.

For China

有关产品中所含有害物质的说明

本资料就本公司产品中所含的特定有害物质及其安全性予以说明。

本资料适用于 2007 年 3 月 1 日以后本公司所制造的产品。

环保使用期限



此标志适用于在中国国内销售的电子信息产品，表示环保使用期限的年数。所谓环保使用期限是指在自制造日起的规定的期限内，产品中所含的有害物质不致引起环境污染，不会对人身、财产造成严重的不良影响。环保使用期限仅在遵照产品使用说明书，正确使用产品的条件下才有效。不当的使用，将会导致有害物质泄漏的危险。

产品中有毒有害物质或元素的名称及含量

部件名称	有毒有害物质或元素					
	铅(Pb)	汞(Hg)	镉(Cd)	六价铬(Cr(VI))	多溴联苯(PBB)	多溴二苯醚(PBDE)
外壳(壳体)	×	○	○	○	○	○
电子部件(印刷电路板等)	×	○	×	○	○	○
附件(电源线、交流适配器等)	×	○	○	○	○	○

○：表示该有毒有害物质在该部件所有均质材料中的含量均在 SJ/T11363-2006 标准规定的限量要求以下。
 ×：表示该有毒有害物质至少在该部件的某一均质材料中的含量超出 SJ/T11363-2006 标准规定的限量要求。
 因根据现有的技术水平，还没有什么物质能够代替它。

For the USA

FEDERAL COMMUNICATIONS COMMISSION RADIO FREQUENCY INTERFERENCE STATEMENT

This equipment has been tested and found to comply with the limits for a Class B digital device, pursuant to Part 15 of the FCC Rules. These limits are designed to provide reasonable protection against harmful interference in a residential installation. This equipment generates, uses, and can radiate radio frequency energy and, if not installed and used in accordance with the instructions, may cause harmful interference to radio communications. However, there is no guarantee that interference will not occur in a particular installation. If this equipment does cause harmful interference to radio or television reception, which can be determined by turning the equipment off and on, the user is encouraged to try to correct the interference by one or more of the following measures:

- Reorient or relocate the receiving antenna.
- Increase the separation between the equipment and receiver.
- Connect the equipment into an outlet on a circuit different from that to which the receiver is connected.
- Consult the dealer or an experienced radio/TV technician for help.

This device complies with Part 15 of the FCC Rules. Operation is subject to the following two conditions:

- (1) this device may not cause harmful interference, and
- (2) this device must accept any interference received, including interference that may cause undesired operation.

This equipment requires shielded interface cables in order to meet FCC class B limit.

Any unauthorized changes or modifications not expressly approved by the party responsible for compliance could void the user's authority to operate the equipment.

For Canada

CAN ICES-3 (B)/NMB-3 (B)

For Korea

사용자 안내문

기종별	사용자 안내문
B 급 기기 (가정용 방송통신기자재)	이 기기는 가정용(B 급) 전자파적합기기로서 주로 가정에서 사용하는 것을 목적으로 하며, 모든지역에서 사용할 수 있습니다.

For C.A. US (Proposition 65)

WARNING

This product contains chemicals known to cause cancer, birth defects and other reproductive harm, including lead.

